



Find out MORE

Assemble Me. Fill Me Up



UGEARS®

Mechanical models

## Model «Antique Box» Модель «Антикварна скринька»

DEU Antik-Schatulle. FRA Boite Antique.  
POL Antyczna szkatulka. SPA Cofrecito de época.  
ITA Cofanetto Antico. RUS Антикварная шкатулка.  
JAP アンティークボックス KOR 앤틱 박스  
CHI 古董盒

### Assembly instructions Інструкція зі складання

DEU Aufbauanleitung. FRA Notice d'assemblage.  
POL Instrukcja montażu. SPA Instrucciones de montaje.  
ITA Istruzioni di montaggio. RUS Инструкция по сборке.  
JAP 組み立て説明書 KOR 조립 설명서.  
CHI 装配说明书



## Mechanical models

### ENG

#### Assembly instructions:

Remove model parts from the hanger board as illustrated below. Careful not to break parts. If a part does not remove easily, carefully cut it out with a knife. This model is intended for self-assembly without glue. If you have difficulty installing the axles, try waxing them with a regular candle. All moving parts can also be waxed during assembly to reduce friction when operating the model.

### UKR

#### Інструкція зі складання:

Витягніть з дошки позначені на схемі деталі. Намагайтеся їх не зламати. Якщо деталь не виймається, надісіть перемички ножом. Конструкція збирається без клею. У разі виникнення труднощів з протягуванням зубчикистки (віли) в отвір, потріть зубчикистку об звичайну свічку. Також можна змастити свічкою всі деталі механізму, що рухаються, щоб зменшити тертя при обертанні.

### DEU

#### Aufbauanleitung:

Bitte die in der Zeichnung angegebenen Teile aus der Platte herausnehmen. Versuchen Sie bitte diese nicht zu brechen. Wenn sich ein Teil nicht herausnehmen lässt, schneiden Sie die Stege mit dem Messer leicht an. Das Modell wird ohne Klebstoffe zusammengebaut. Lässt sich eine Achse nur schwer in eine Öffnung einführen, reiben Sie diese mit einer Kerze etwas ein. Für besseres Gleiten schmierien Sie alle beweglichen Teile mit einer Kerze.

### FRA

#### Notice d'assemblage:

Faites sortir de la planche les pièces comme indiquées sur le schéma. Tâchez de ne pas les casser. Si la pièce ne sort pas, incisez les collages/fixations avec un couteau. La construction est à assembler sans colle. Si il est difficile d'introduire l'axe en bois dans l'orifice, frottez au préalable l'axe ou les pièces contre une bougie. Pour améliorer le glissement, traitez les pièces de frottement mobiles du mécanisme avec une bougie au cours d'assemblage.

### POL

#### Instrukcja montażu:

Delikatnie wyciągaj z deseczki wskazane w schemacie detale, starając się nie połamać elementów. Jeśli detal nie poddaje się, podetnij wiązadła nożem. Konstrukcje składa się bez kleju. Jeśli napotkasz trudności z instalacją drewnianej osi lub detale o woskową świecę. Dla lepszego poślizgu polecano smarowanie ruchomych części mechanizmu zwykłą świecą podczas montażu.

### SPA

#### Instrucciones de montaje:

Saque de la tabla las piezas marcadas en el esquema. Trate de no romperlas. Si una pieza no se saca, haga una incisión. La construcción va sin pegamento. Si tiene dificultades con la instalación del eje de madera en un agujero, frote primero el eje o las piezas contra una vela. Para un mejor deslizamiento, lubrique durante el montaje las piezas móviles del mecanismo con una vela común.

ENG Warning! UKR Увага! DEU Achtung! FRA Attention!

POL Uwaga! SPA Precaución! ITA Attenzione!

RUS Внимание! JAP 注意! KOR 주의! CHI 注意!



ENG Do not use a lighted candle!  
UKR Не підпалювати!  
DEU Nicht anzünden!  
FRA Ne pas brûler!  
POL Nie podpalać!  
SPA ¡No encender!  
ITA Non dare fuoco!  
RUS Не поджигать!  
JAP 火のついたろうソクの使用はお止めください。  
KOR 불이 붙은 촛를 이용하지 마세요!  
CHI 请勿点燃，请勿靠近火源!

### ITA

#### Istruzioni di montaggio:

Estrarre dal telaio i particolari indicati nello schema. Fare attenzione a non romperli. Se un particolare non si stacca, tagliare delicatamente gli elementi di collegamento con un coltello. L'assieme viene realizzato senza colla. In caso di difficoltà nell'inserimento di un perno in legno, è necessario sfregare il perno o il particolare con un po' di cera. Per uno scorrimento migliore incerare le parti mobili del meccanismo durante l'assemblaggio.

### RUS

#### Інструкція по сборке:

Вынимайте из доски обозначенные на схеме детали. Старайтесь их не сломать. Если деталь не извлекается, надрежьте перемычки ножом. Конструкция собирается без клея. Если возникли трудности с установкой деревянной оси, перед установкой потрите детали об обычную свечу. Для лучшего скольжения смазывайте движущиеся детали механизма обычной свечой во время сборки.

### JAP

#### 組み立て説明書:

部品に傷をつけないように注意しながらボードから外してください。部品が外れにくい場合は、連結部分をカッターで切つてから外すと外しやすいです。本製品は、接着剤がなくても組み立てができるように設計されています。もしアックスル(駆動部)が、歯車の動きがにぶい場合は、口ワソクをアックスルに塗ってください。全ての駆動部分は製品を動かす時、滑らかに動くように潤滑剤である口ワソクを塗りながら組み立てます。

### KOR

#### 조립 설명:

부품이 손상되지 않도록 주의하여 보드에서 떼어냅니다. 만약 부품이 잘 떨어지지 않으면 연결 부분을 칼로 잘라 한 후 떼어내면 쉽게 떼어 낼 수 있습니다. 본 제품은 접착제가 없이 조립이 가능하도록 설계되어 있습니다. 만약 축이 잘 끼워지지 않는 경우 양초를 축에 바른 후 끼워주세요. 모든 구동 부위는 제품 구동 시 원활한 작동이 가능하도록 조립 과정에서 윤활제(양초)양초를 발라주세요.

### CHI

#### 装配说明:

将模型部件按插插图示，从胶合板取下。小心不要损坏零件。如果取下时候有难度，请用小刀小心的切割连接点。这个产品不需要胶水粘接。如果安装转轴的时候有难度，请用普通的蜡加以润滑。所有的转动部分也需要打蜡润滑。



ENG Spare parts. UKR Запасні деталі. DEU Ersatzteile. FRA Pièces de rechange. POL Części zamienne. SPA Piezas de repuesto. ITA Pezzi di ricambio. RUS Запасные детали. JAP 予備部品 KOR 여유 부품입니다. CHI 备用件

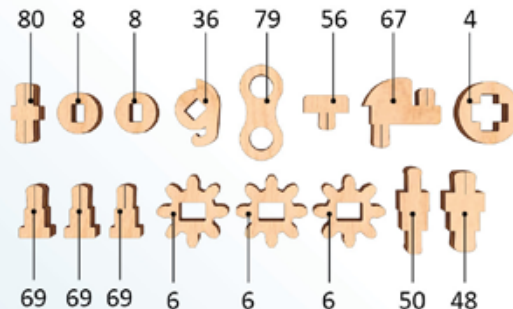

ENG Customer support UKR Служба підтримки DEU Kundendienst FRA Service client POL Wsparcie klienta

SPA Servicio al cliente ITA Servizio di supporto RUS Служба поддержки JAP お客様窓口 KOR 고객센터 CHI 客户支持

customerservice@ugearsmodels.com





**ENG** Wax the part with a regular candle (rub with a candle). **UKR** Змастіть деталь звичайною свічкою (потріть об свічку). **DEU** Reiben Sie das Teil mit einer einfachen Kerze etwas ein. **FRA** Lubrifiez la pièce avec une bougie ordinaire (frottez contre la bougie). **POL** Przesmaruj zwykłą świecą. **SPA** Engrase la pieza con una vela común (frote con una vela). **ITA** Incerare il componente (Sfregare con la cera). **RUS** Смажьте деталь обычной свечкой (потрите о свечку). **JAP** 表示された部分に潤滑剤としてロウソクを塗ってください。 **KOR** 표시된 부분에 윤활을 위해 초를 칠해 주세요. **CHI** 用普通蜡烛涂抹润滑部件。



**ENG** Pay attention. Check for correct orientation or positioning. **UKR** Зверніть увагу. Перевірте розташування елемента. **DEU** Bitte Beachten. Prüfen Sie die Einbaulage des Elementes. **FRA** Faites attention. Vérifiez la disposition de l'élément. **POL** Zwróć uwagę. Sprawdź lokalizację elementu. **SPA** Atención. Compruebe la situación del elemento. **ITA** Prestare attenzione. Controllare la posizione del componente. **RUS** Обратите внимание. Проверьте расположение элемента. **JAP** 方向及び位置に注意して組み立ててください。 **KOR** 방향 또는 위치에 주의해서 조립해 주세요. **CHI** 注意！检查部件方向和位置



**ENG** Sand to remove burrs. **UKR** Видалить задирки. **DEU** Grate entfernen. **FRA** Eliminez les bavures. **POL** Usuń zadziory. **SPA** Quite las rebabas. **ITA** Togliere le bave. **RUS** Удалите заусенцы. **JAP** バリ取りのサンドペーパー **KOR** 거친 부분을 닦아 주세요. **CHI** 磨掉毛刺



**ENG** Check the mechanism for smooth and correct movement. Operate the mechanism to seat the parts in their positions. **UKR** Перевірте механізм на плавність і точність ходу. Розробіть механізм. **DEU** Prüfen sie den Mechanismus bezüglich der Laufruhe und der Genauigkeit des Ganges. Arbeiten Sie den Mechanismus aus. **FRA** Vérifiez si le mécanisme fonctionne en douceur et avec précision. Faites fonctionner le mécanisme jusqu'à son fonctionnement normal. **POL** Sprawdź płynność i dokładność ruchu mechanizmu. Dopracuj mechanizm. **SPA** Verifique la suavidad y precisión del mecanismo. Desarrolle el mecanismo. **ITA** Controllare la scorrevolezza e la precisione del movimento. Far funzionare il meccanismo. **RUS** Проверьте механизм на плавность и точность хода. Разработайте механизм. **JAP** 駆動部分が滑らかに動くかを確認しながら作業をすすめます。 **KOR** 구동 부분의 원활한 작동과 정확한 움직임을 확인하세요. **CHI** 检查机构的运行平稳度和精密度。调试机构



**ENG** Check size. **UKR** Перевірте розмір. **DEU** Prüfen Sie die Größe. **FRA** Vérifiez la dimension. **POL** Sprawdź rozmiar. **SPA** Compruebe el tamaño. **ITA** Controllare le dimensioni. **RUS** Проверьте размер. **JAP** サイズをチェックしてください。 **KOR** 크기를 확인해 주세요. **CHI** 測量尺寸

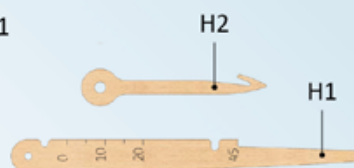
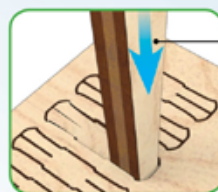

**ENG** This is not a structural component; it is a tool for measurement and assembly. **UKR** Це не деталь конструкції, а допоміжний інструмент для складання або вимірювання відстаней. **DEU** Es ist kein Teil der Konstruktion, sondern ein Hilfselement für den Zusammenbau oder für das Messen der Abstände. **FRA** Cette pièce ne fait pas partie de la construction mais constitue un outil anexe pour l'assemblage ou la mesure des distances. **POL** To nie detal konstrukcji, a pomocnicze narzędzie dla montażu i wymiaru odległości. **SPA** No es una pieza de la construcción sino un instrumento auxiliar para montar o para medir distancias. **ITA** Non è un componente del modello, ma un'attrezzatura aggluntiva per il montaggio o il rilievo delle quote. **RUS** Это не деталь конструкции, а вспомогательный инструмент для сборки или измерения расстояний. **JAP** この部品は完成時の部品ではなく、組み立てをサポートしたり測定する道具です。 **KOR** 이 부품은 조립을 위한 부품이 아니고 조립을 돕거나 측정을 위한 도구입니다. **CHI** 这不是装配零部件，是一种测量及安装辅助工具。



1



2

1

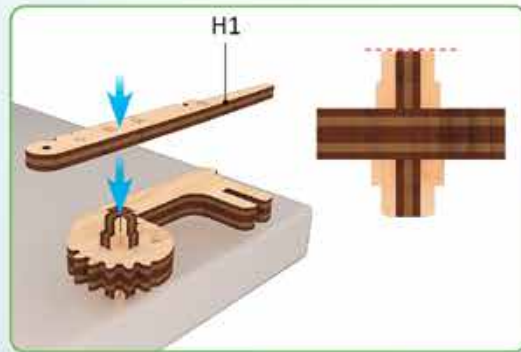
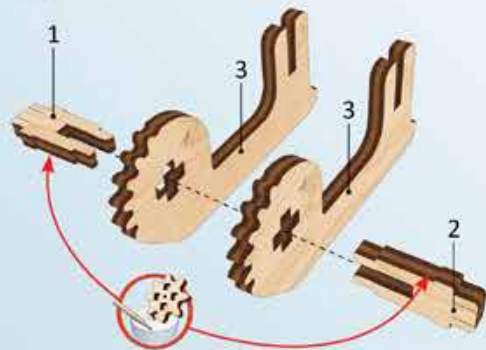

2

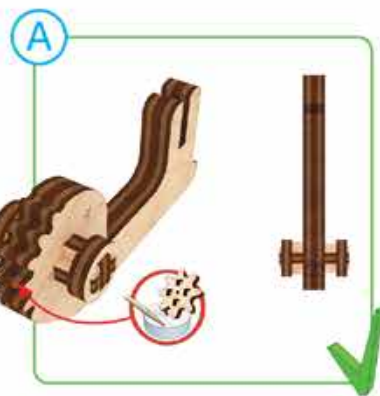
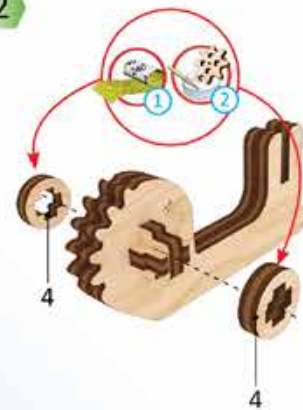

3

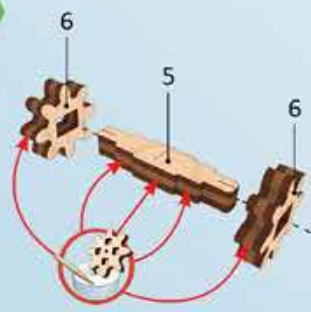

4

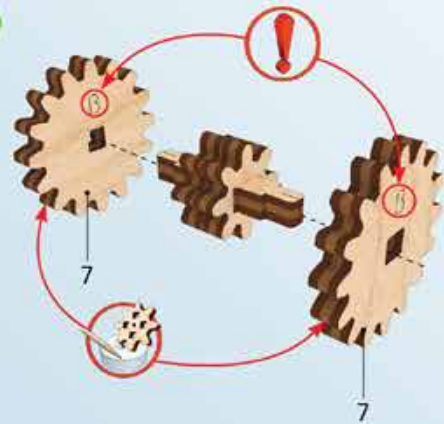

5

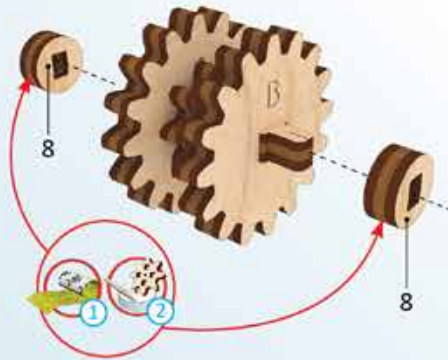

B

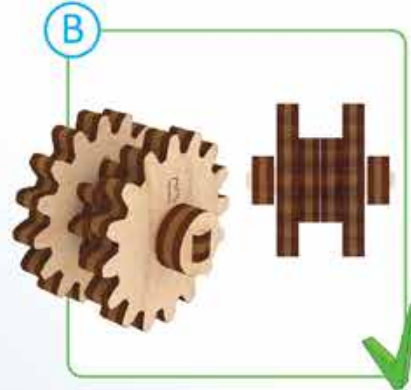

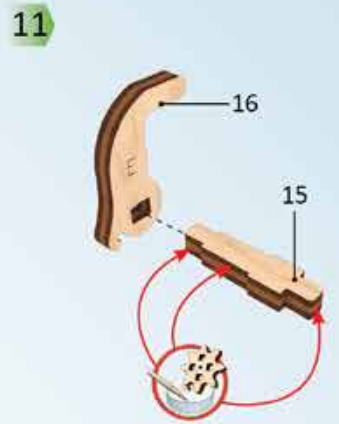
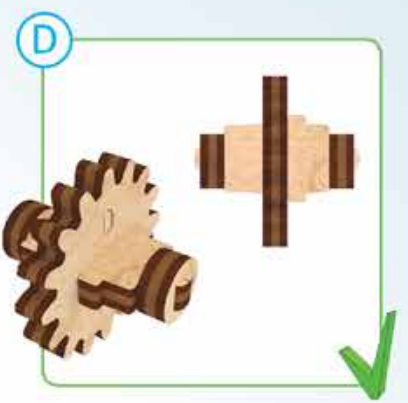
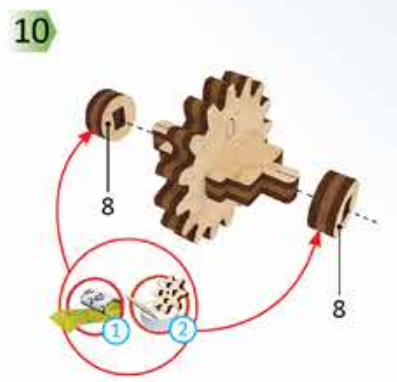
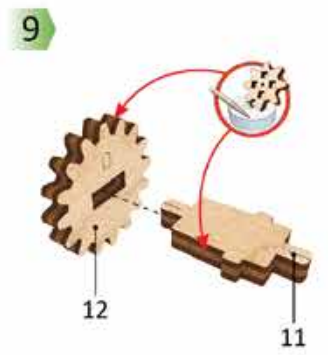
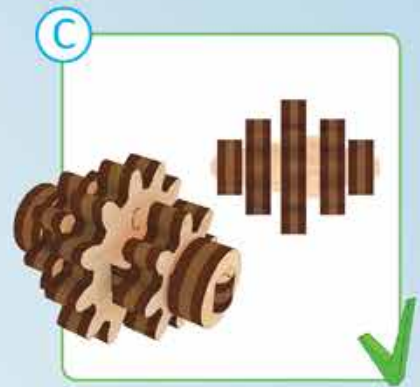
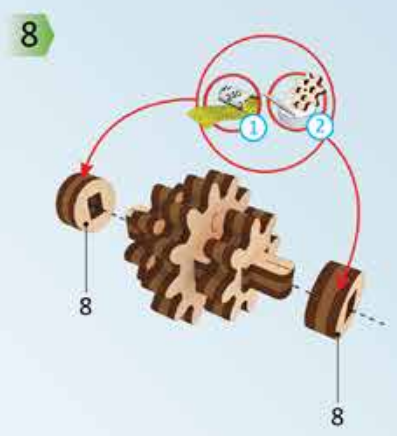
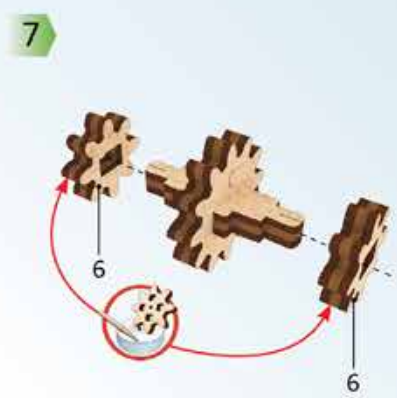
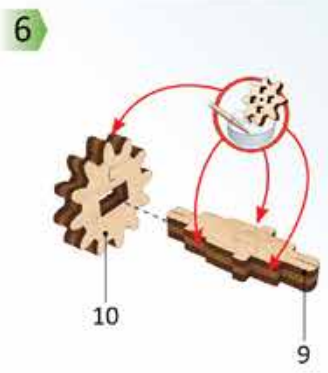





①

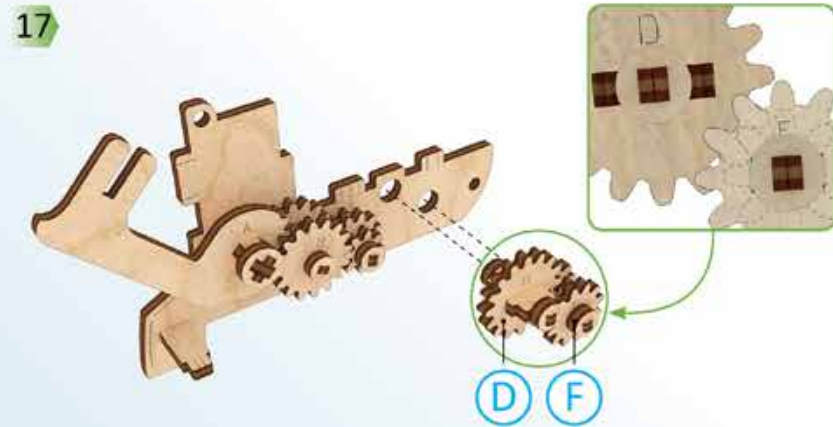
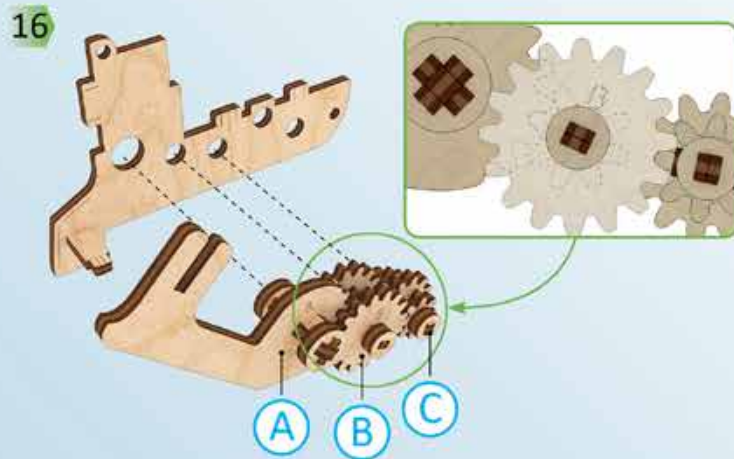
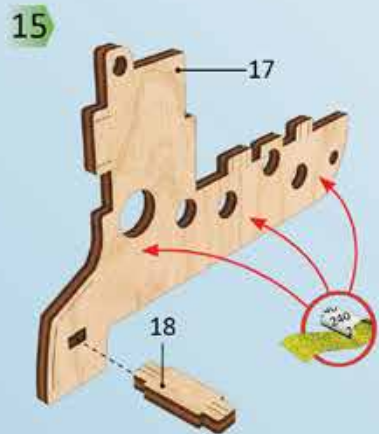
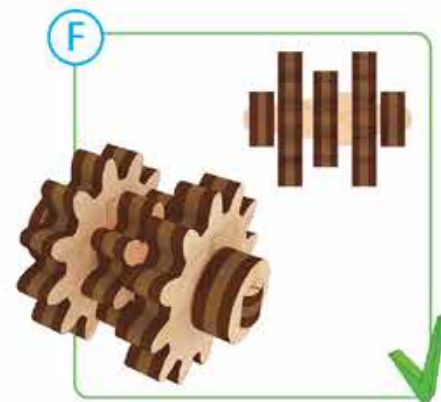
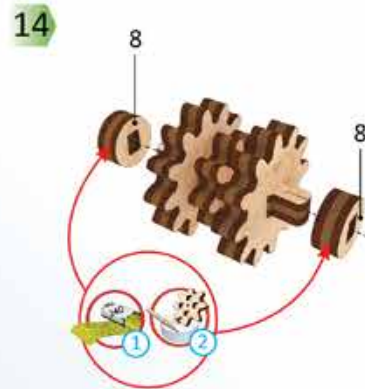
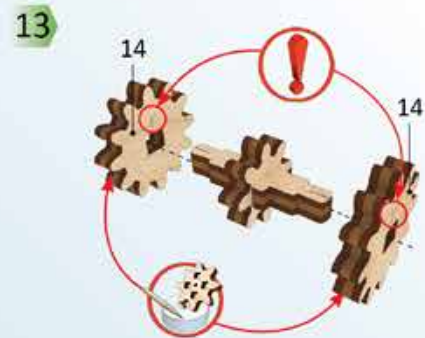

⑥



18



19

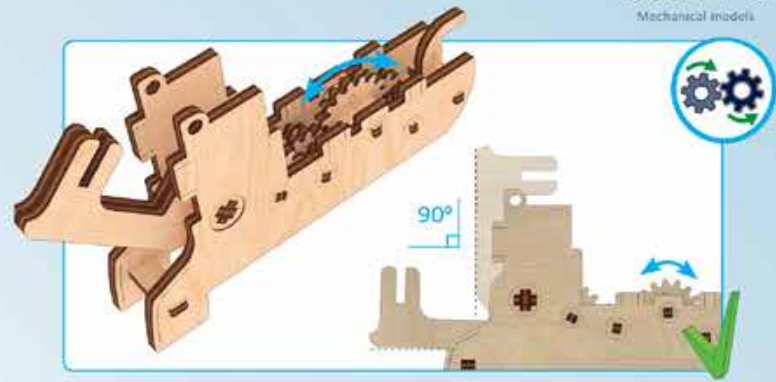
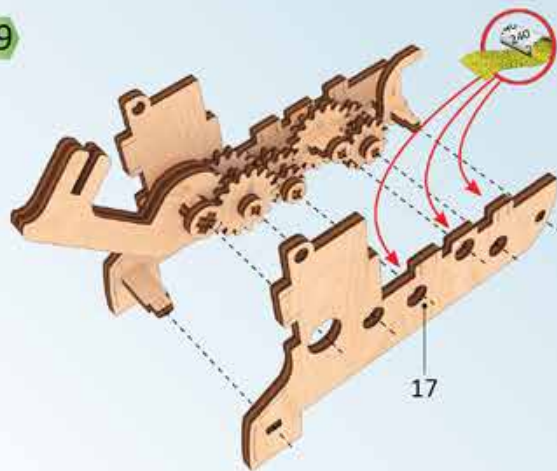

1

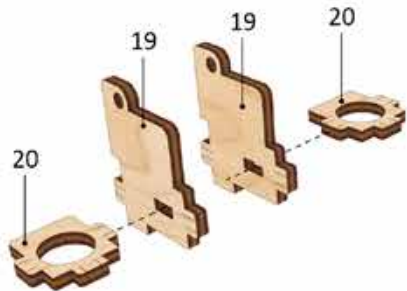

2

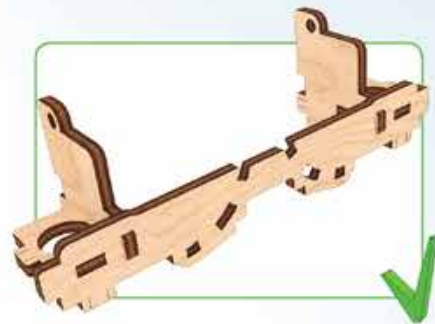
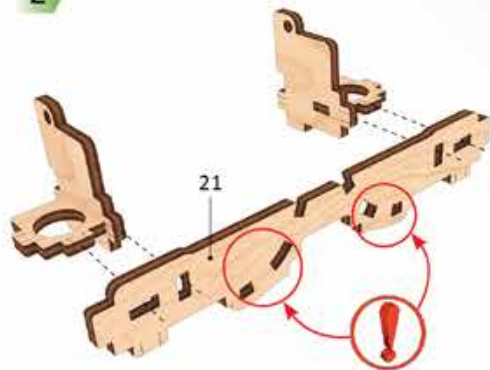

3

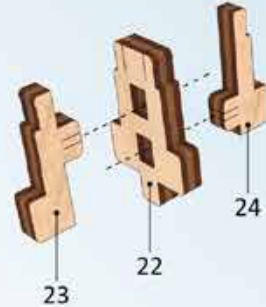

4

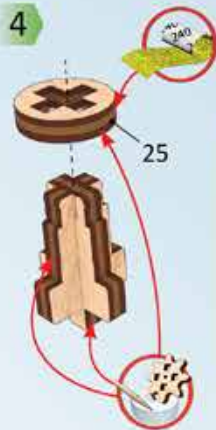



5

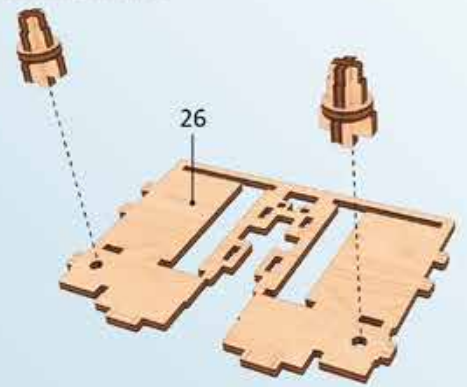

6

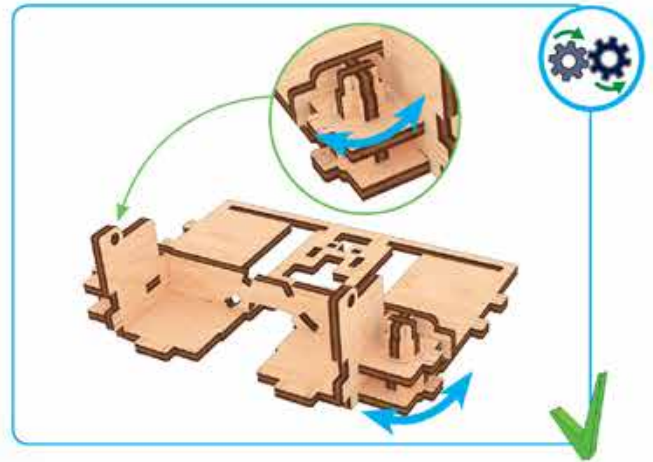
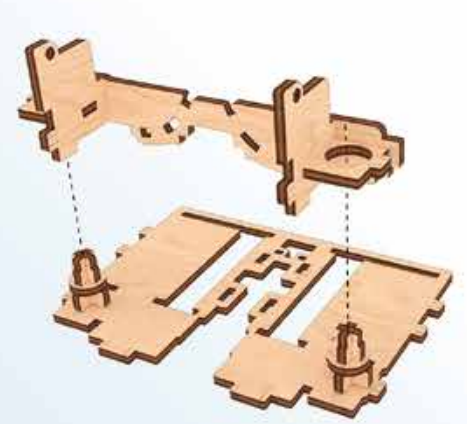

7

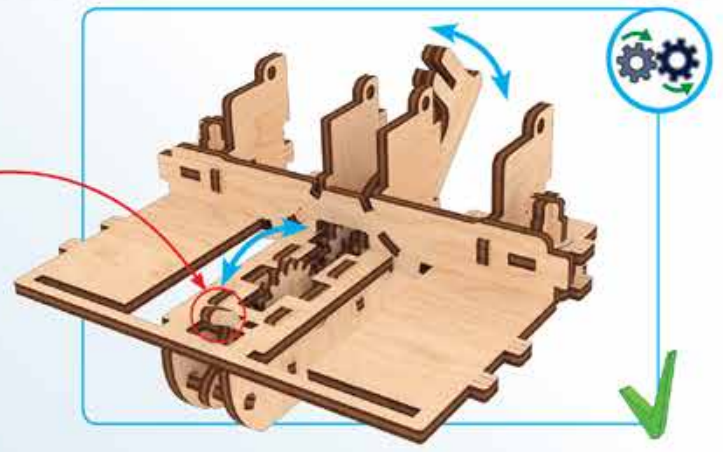
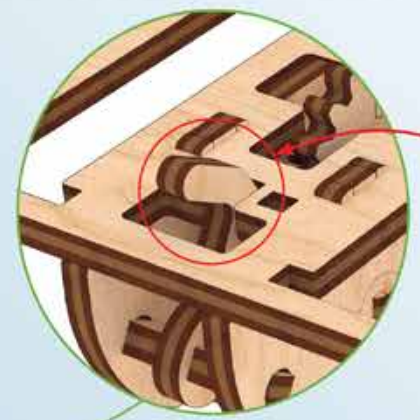
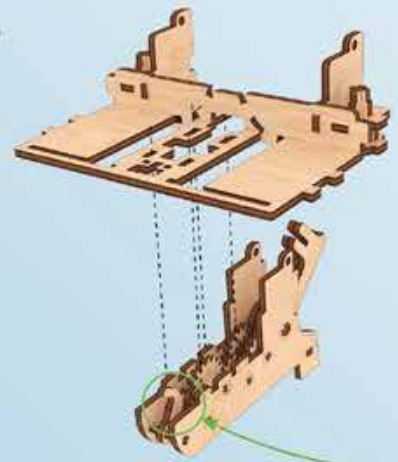





1

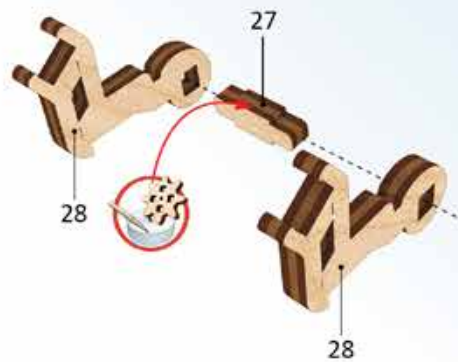

2

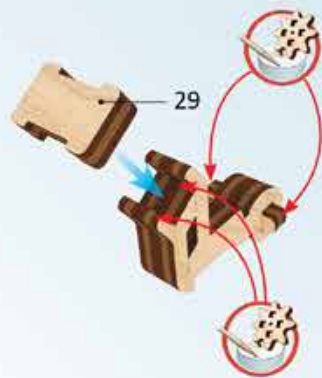

3

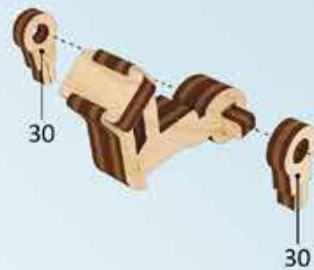

4



5

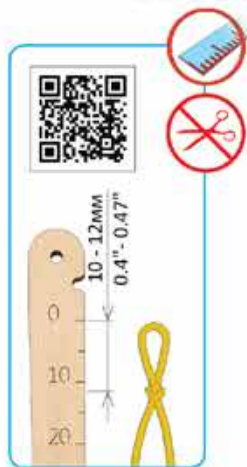

6

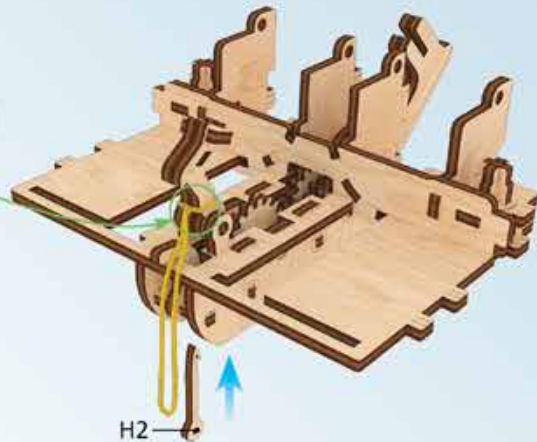
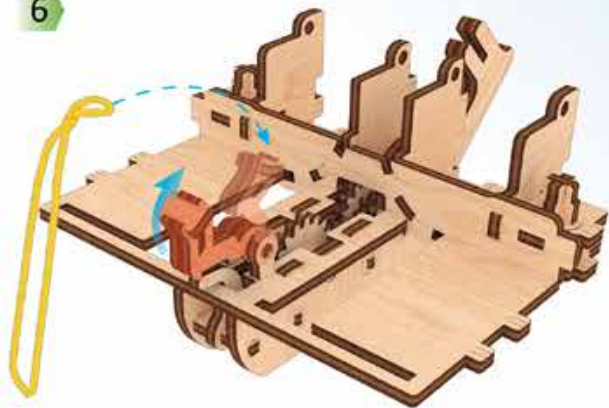



②

7



1

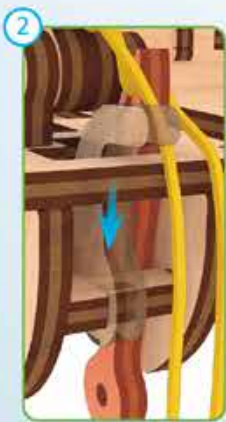

2



3

8

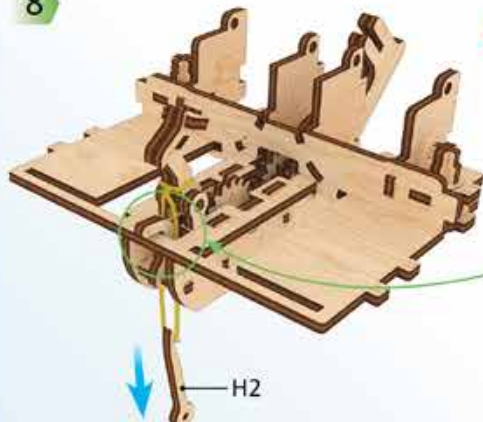

H2



4



5



6

1

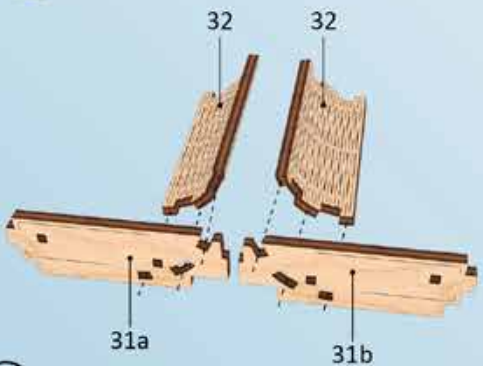

32

32

31a

31b

2

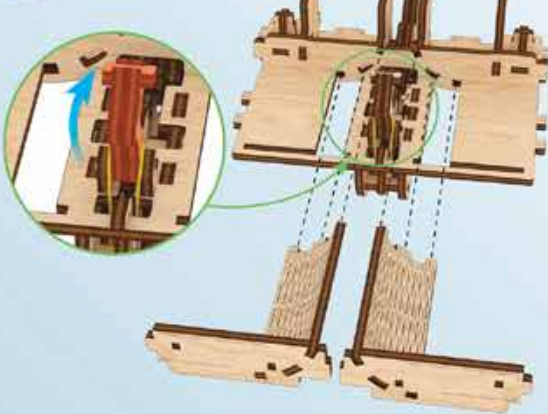

3

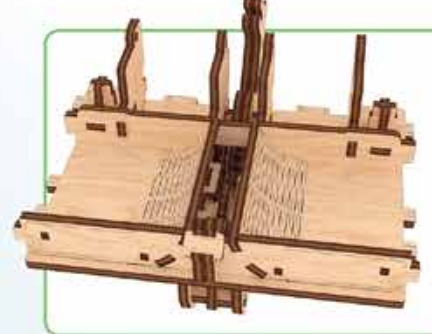
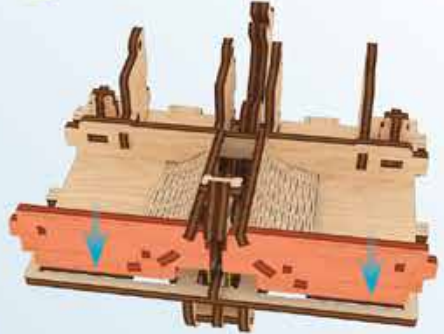

10





1

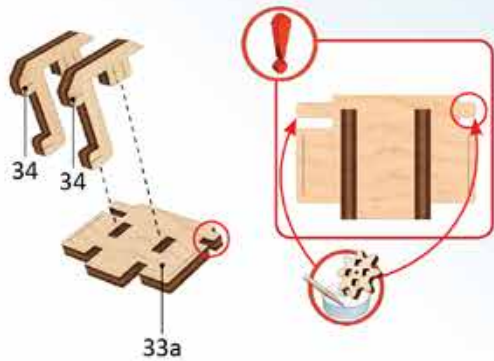

2

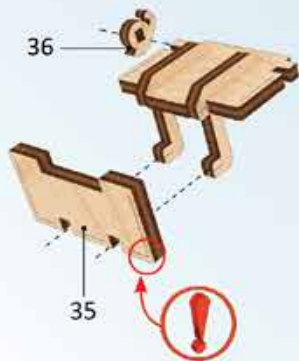

G



1

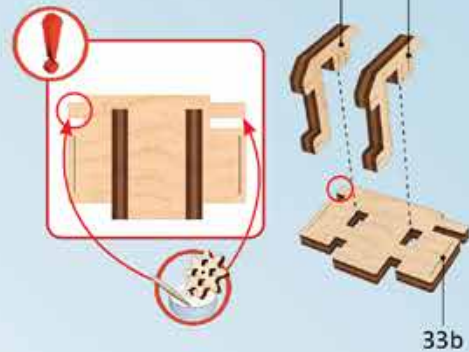

2

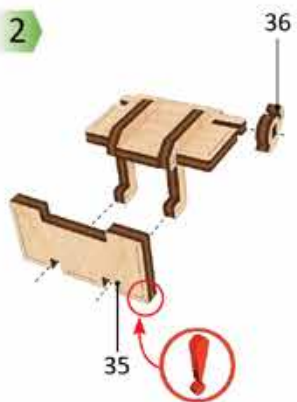

H



1



2

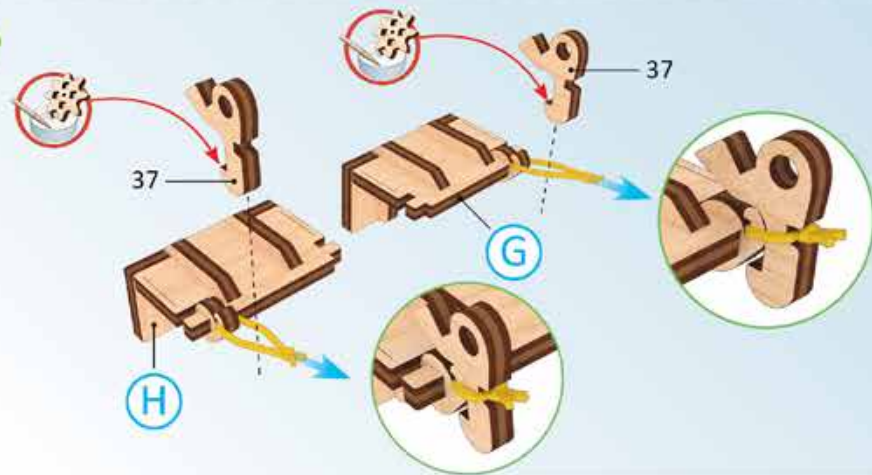

3



4

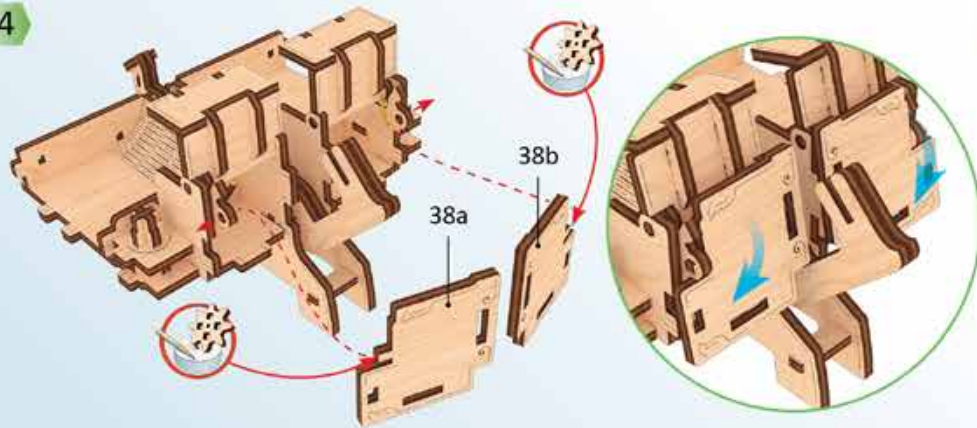

5

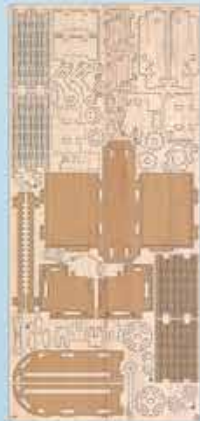
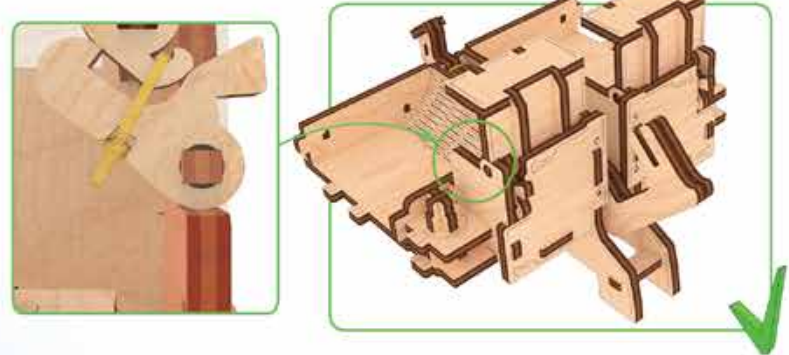

1

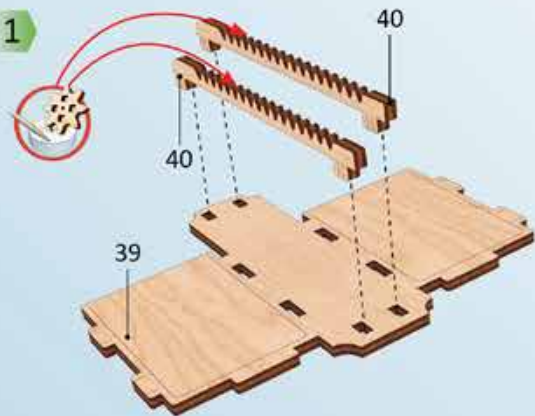

2

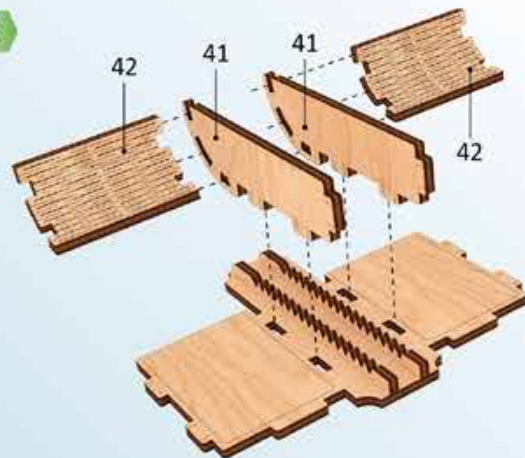

3

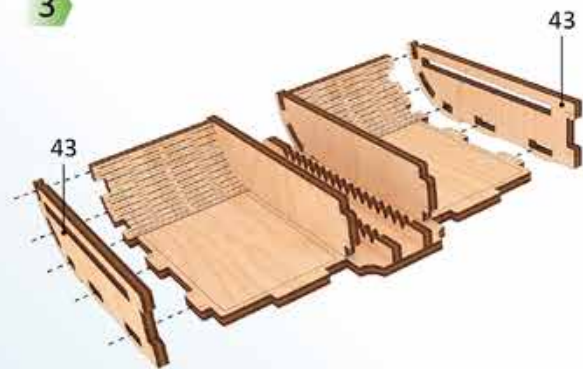



4

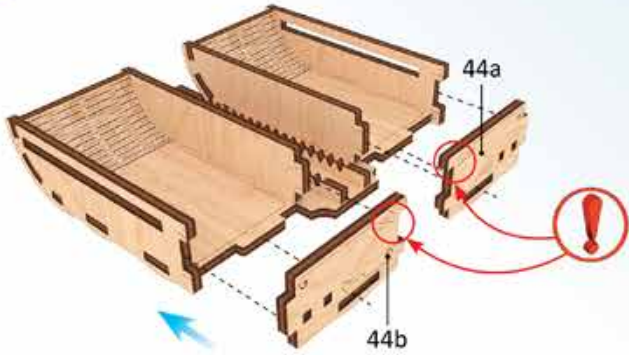

5

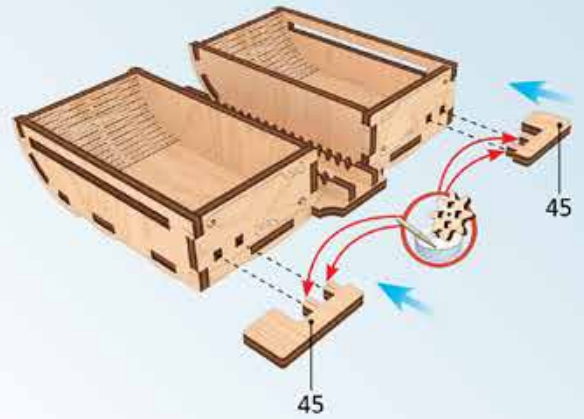

6

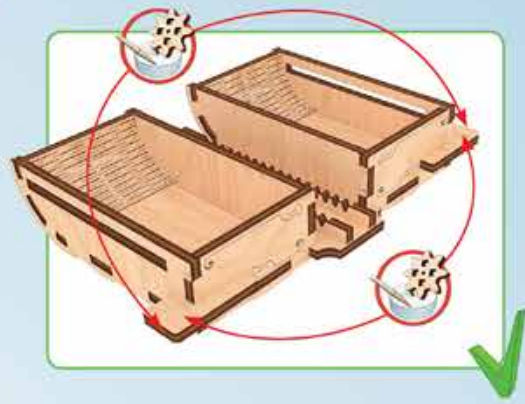

2



3

7

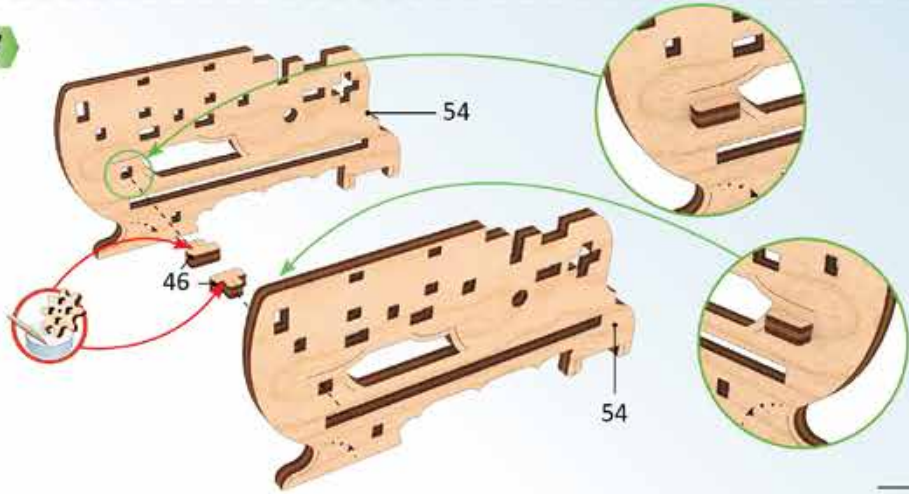



②



③

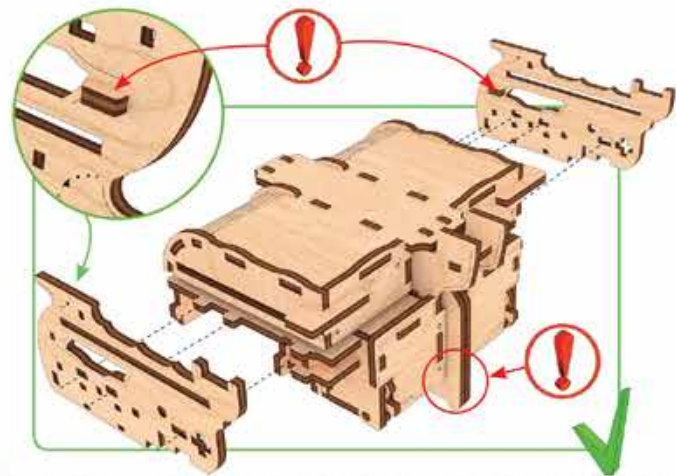
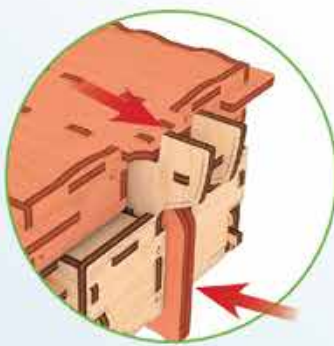
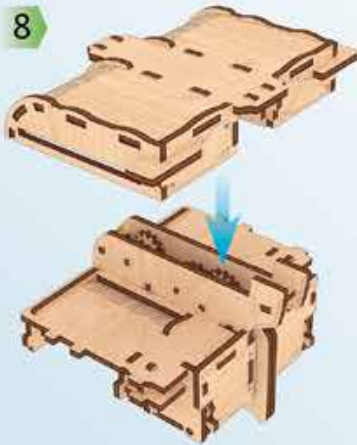

1



53



2

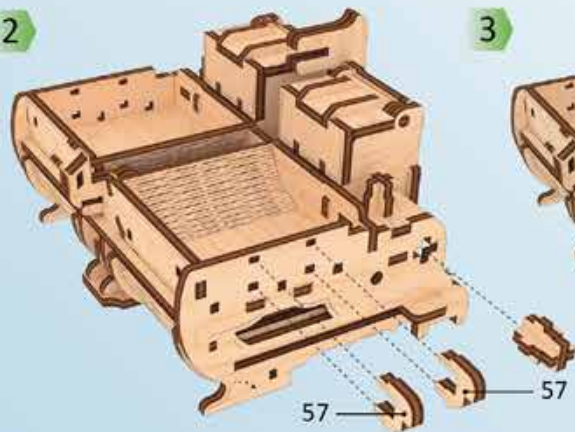

57

3

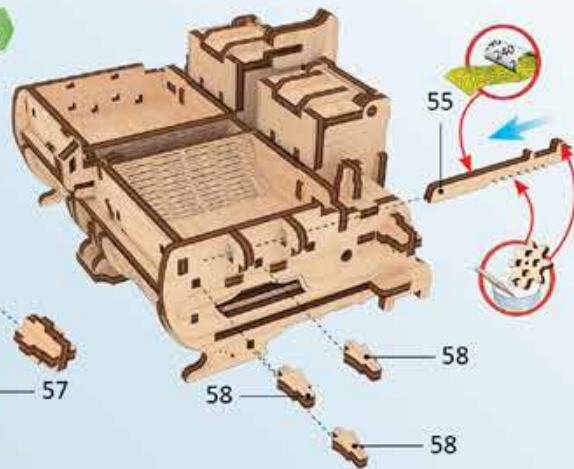

55

58

58

58

4



48

47



R1

5

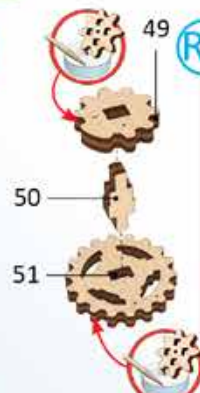

49

50

51



R2



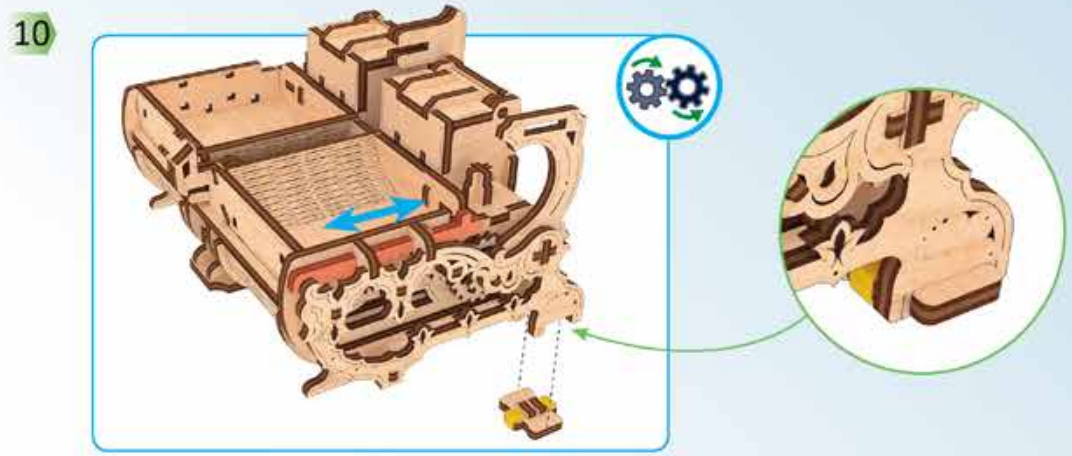
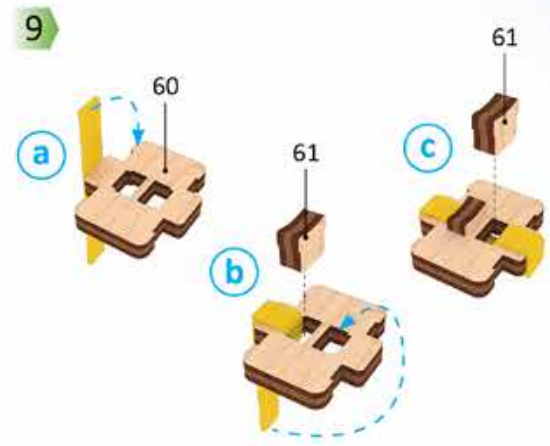
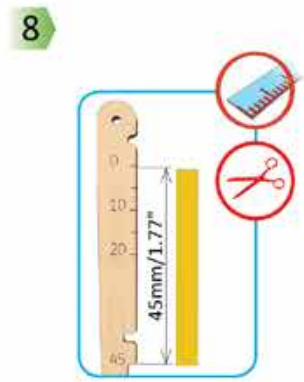
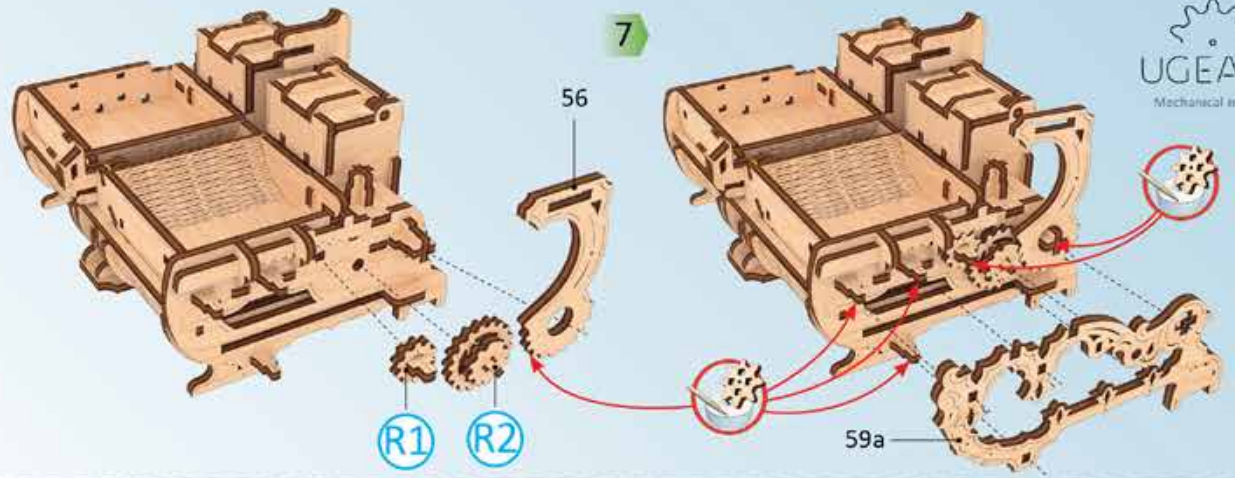



③

1

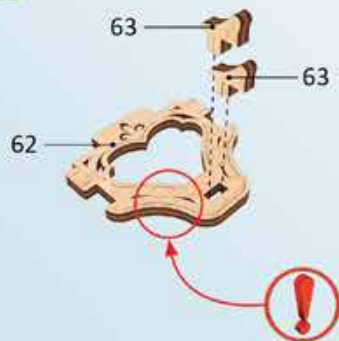

2

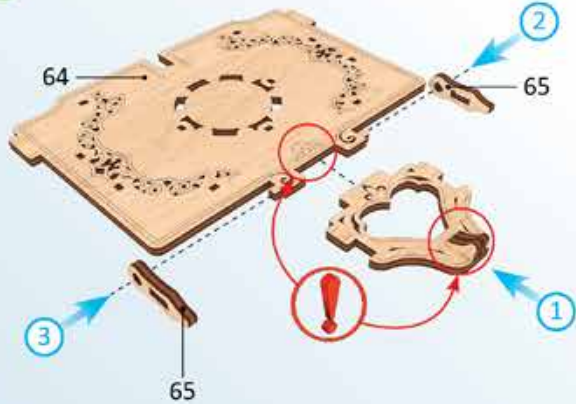

3

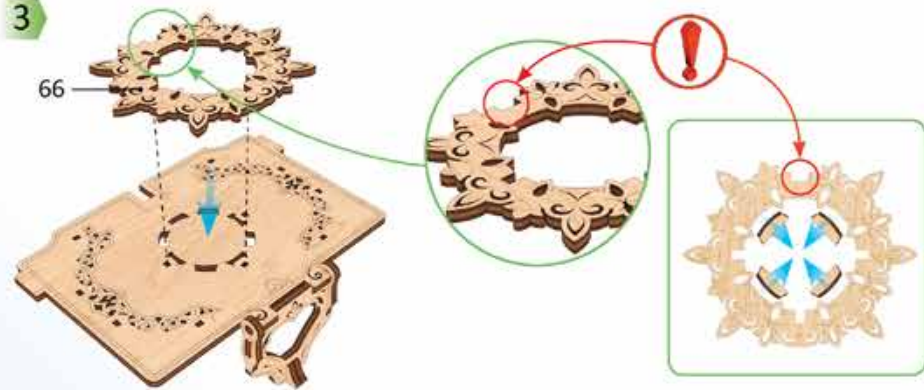

④

4

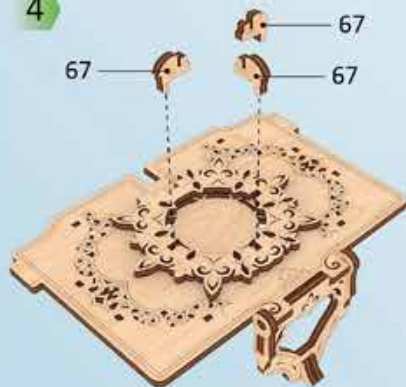

5

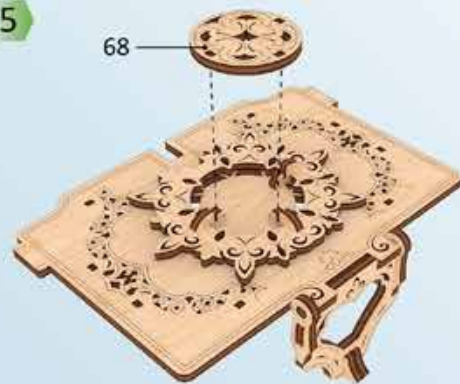

6

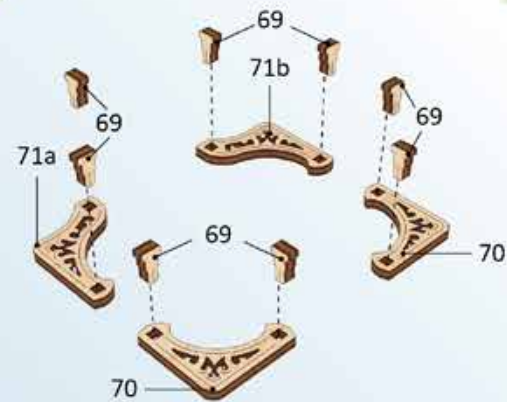

7





8

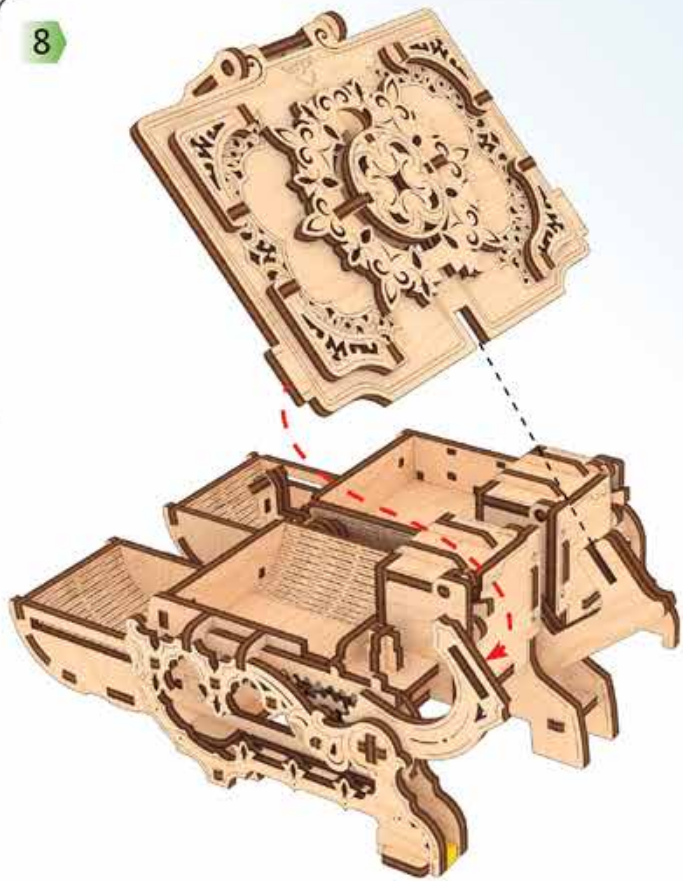

9

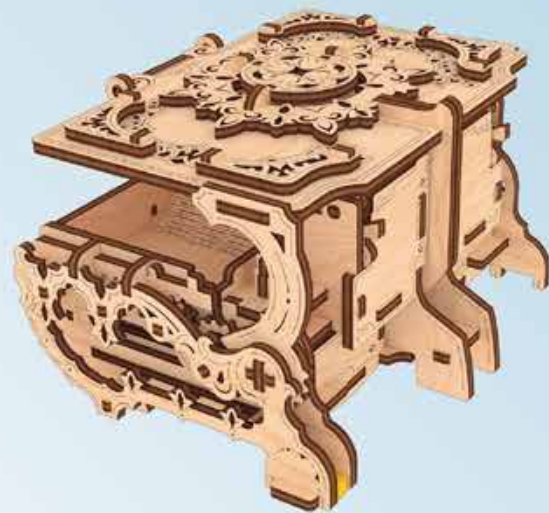
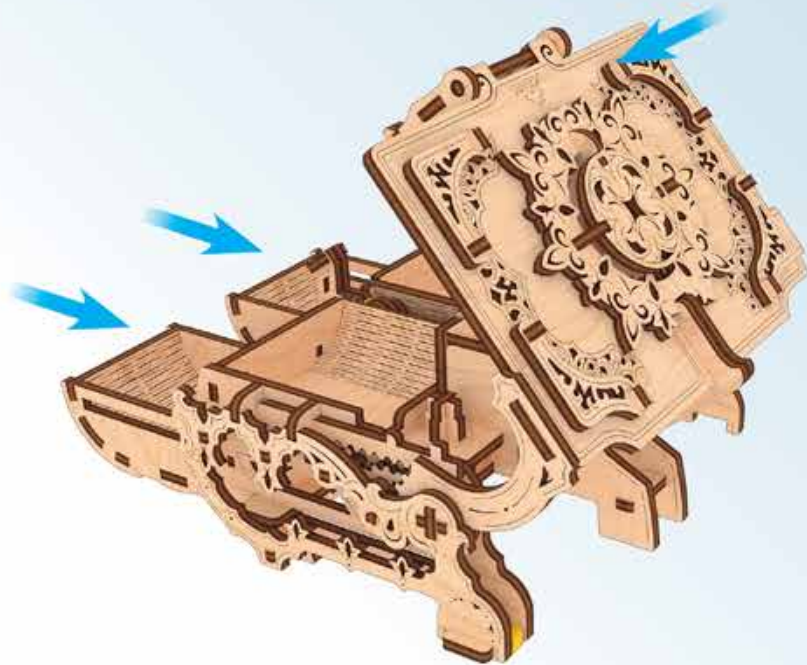



②



③

1



2

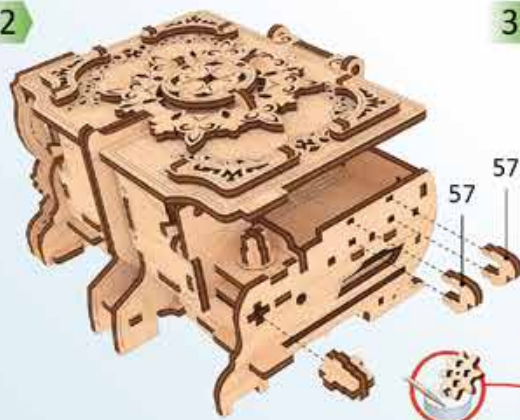

3

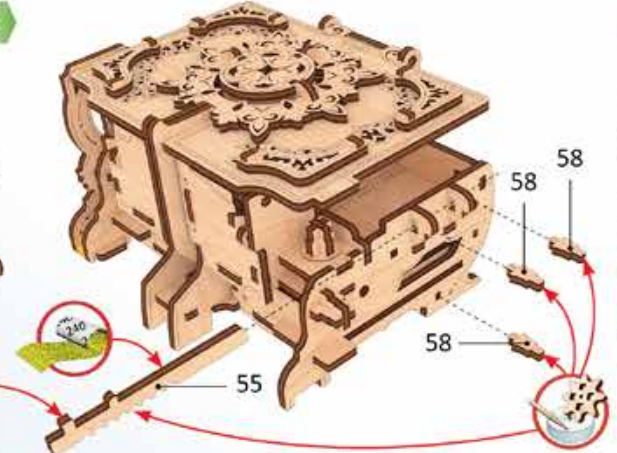

4



L1



5

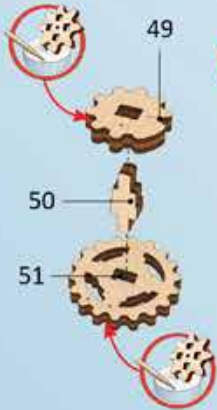

L2



6



7

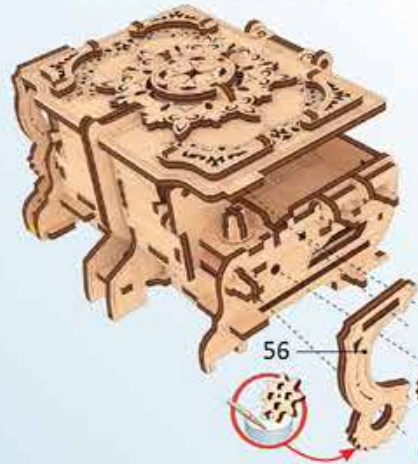

L2

L1

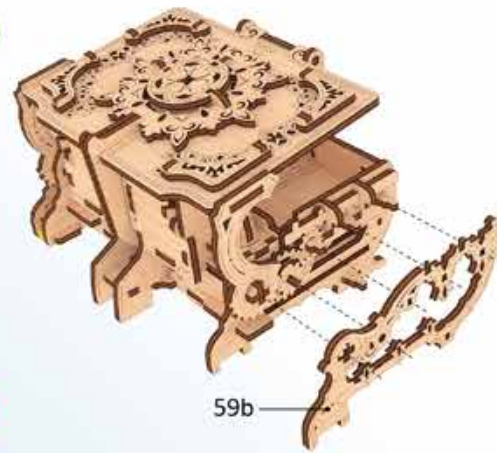

59b



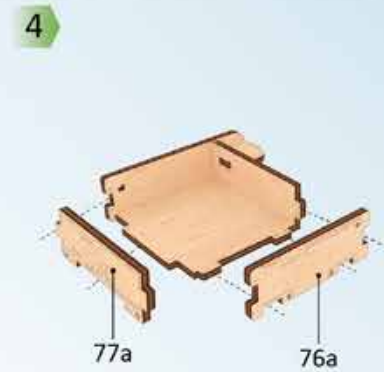
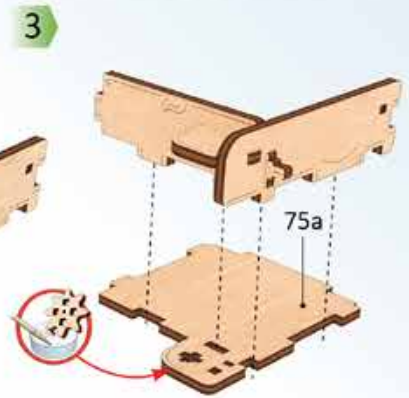
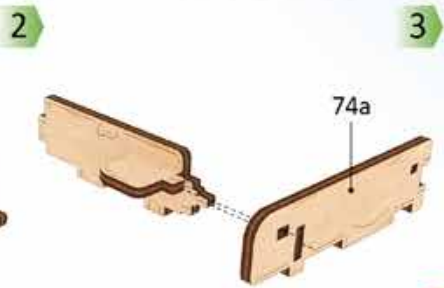
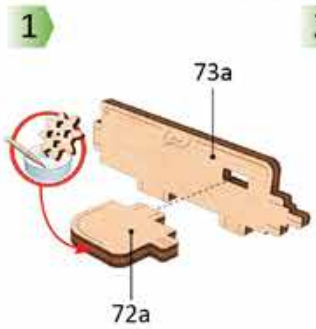
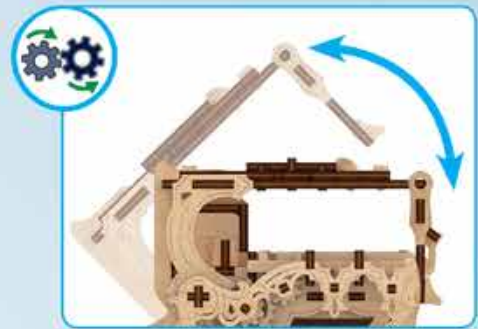
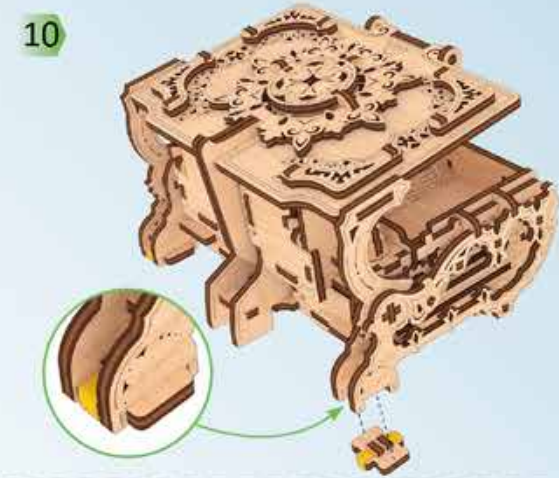
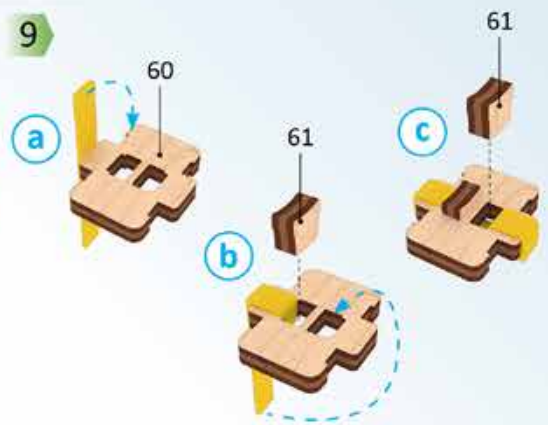
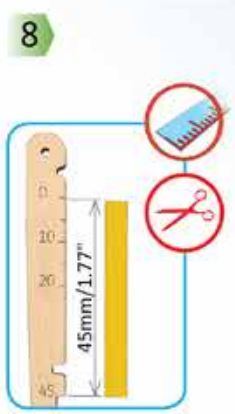



①



③

1

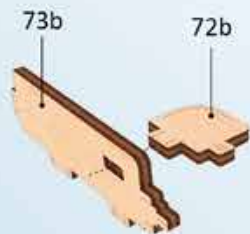

2

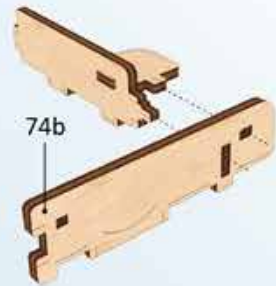

3



4



K



④

1

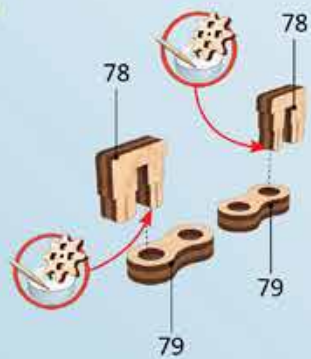

2

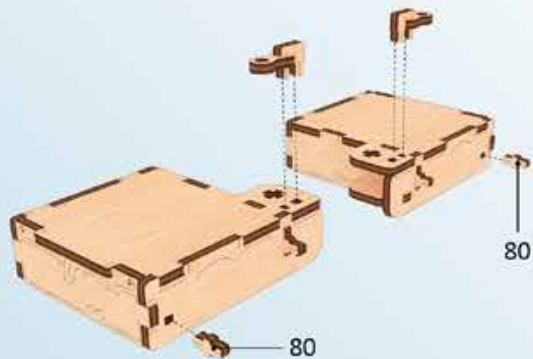

J



K





5

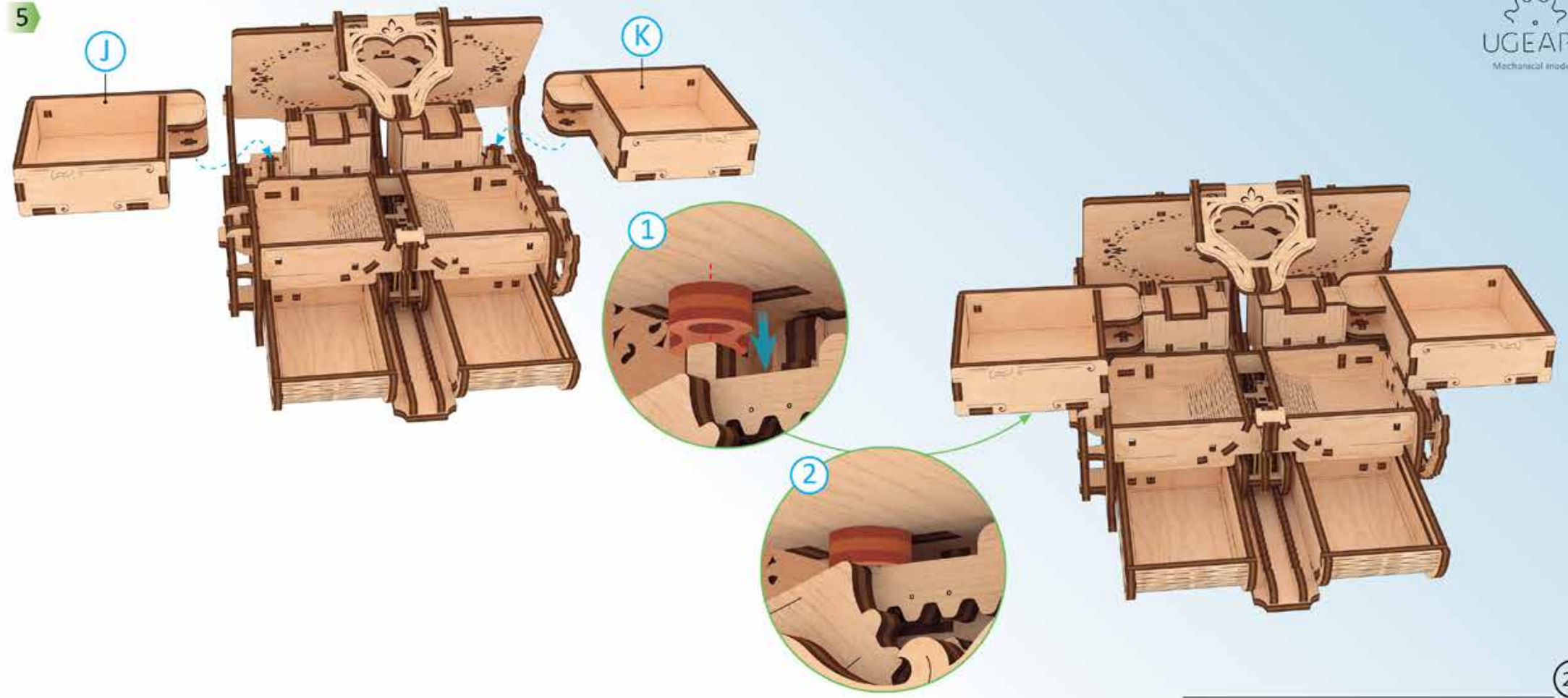

1



③

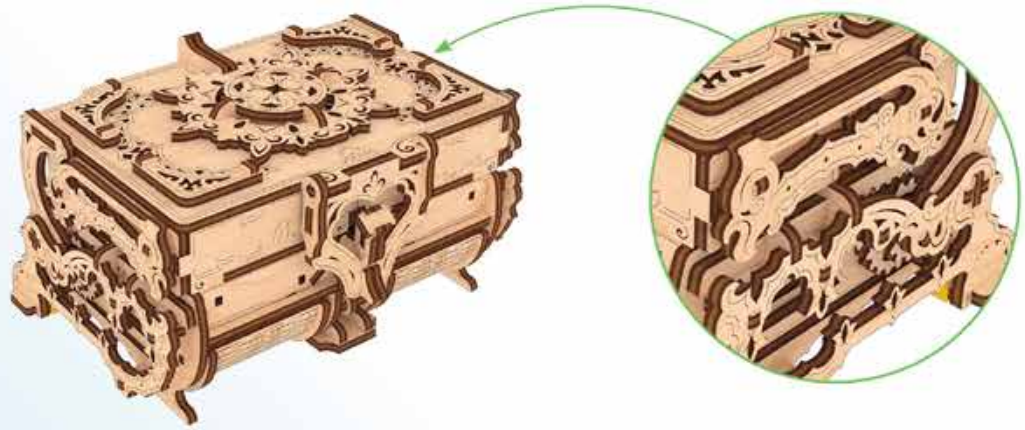
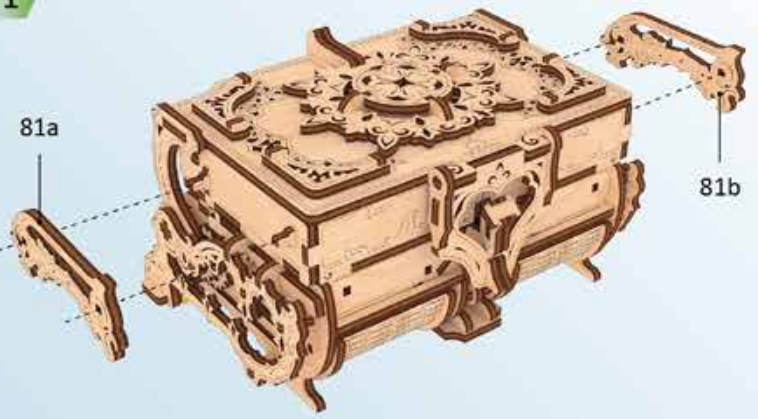

2



④

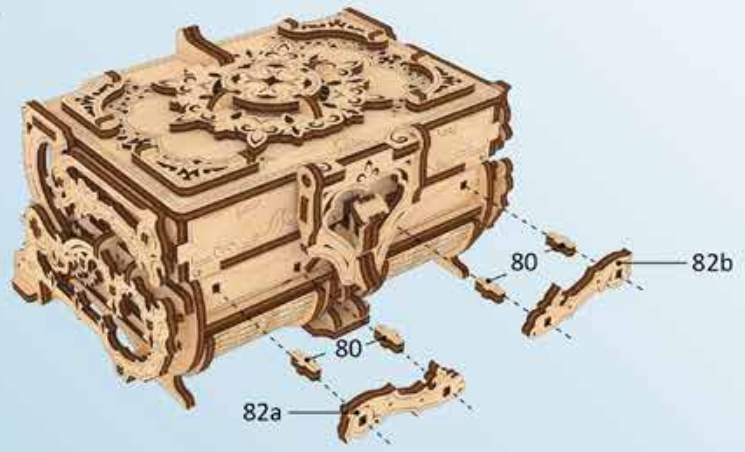



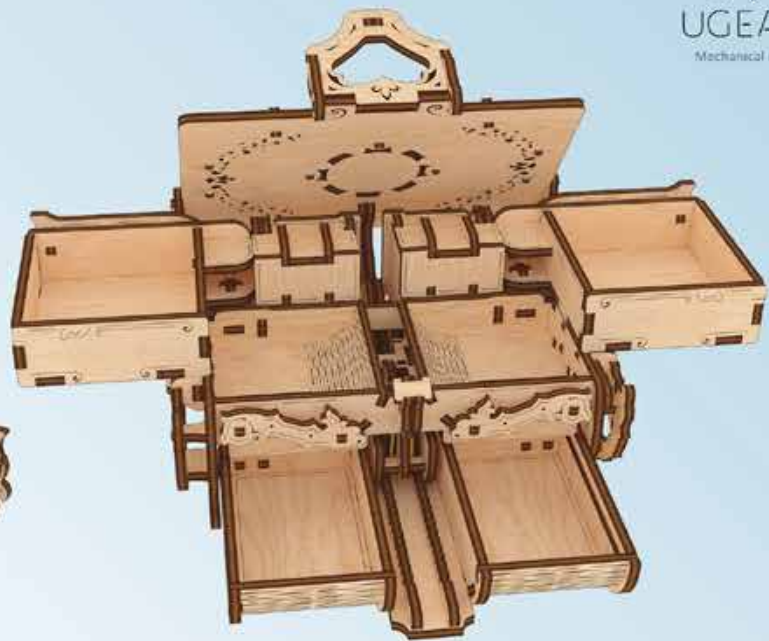
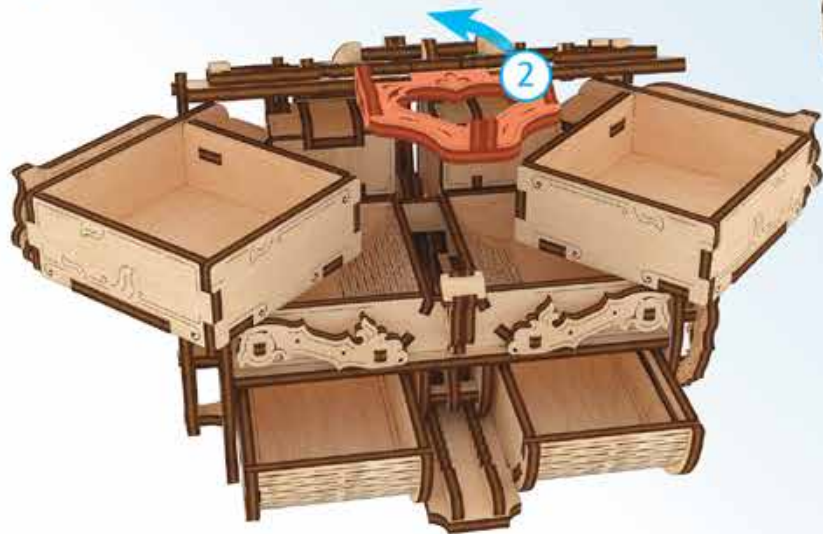



ENG Thanks for following along on this journey with us. UKR Дякуємо, що ви пройшли цей шлях з нами. DEU Vielen Dank, dass Sie diesen Weg mit uns gegangen sind. FRA Merci denous avoir accompagnés tout au long de ces étapes. POL Dziękujemy, że razem z nami pokonałeś tę drogę! SPA Gracias por haber recorrido el camino con nosotros. ITA Grazie per aver fatto uesto percorso con noi. RUS Спасибо, что вы прошли этот путь с нами. JAP UGEARSをご利用いただきありがとうございます。KOR UGEARS 와 함께해 주셔서 감사합니다. CHI 感谢您参与有趣的模型装配过程。

ENG Customer support UKR Служба підтримки DEU Kundendienst FRA Service client POL Wsparcie klienta  
SPA Servicio al cliente ITA Servizio di supporto RUS Служба поддержки JAP お客様窓口 KOR 고객지원 CHI 客户支持

[customerservice@ugearsmodels.com](mailto:customerservice@ugearsmodels.com)

[ugearsmodels.com](http://ugearsmodels.com)