

UGEARS®
Mechanical models

Model "Kluis"

DEU Modell «Safe». **FRA** Modèle «Coffre-fort». **POL** Model «Sejf». **SPA** Modelo «Cajafuerte». **ITA** Modello «Cassaforte». **TUR** «Kasa» modeli. **RUS** Модель «Сейф». **KOR** 금고. **CHI** «保險櫃»模型

Handleiding in het Nederlands

DEU Aufbauanleitung. **FRA** Notice d'assemblage. **POL** Instrukcja montażu. **SPA** Instrucciones de montaje. **ITA** Istruzioni di montaggio. **TUR** Kurulum talimatı. **RUS** Инструкция по сборке. **KOR** 조립 설명서. **CHI** 装配说明书

NED

Bouwinstructies.

Verwijder de onderdelen van de borden zoals hieronder is geïllustreerd. Pas op dat de onderdelen niet breken. Wanneer het niet loskomt, gebruik dan voorzichtig een mesje. Dit model bouwt u zelf zonder gebruik te maken van lijm. Wanneer onderdelen moeilijk te plaatsen zijn. Smeer deze dan in met een kaars. Om frictie te voorkomen behandelt u ook alle beweegbare onderdelen met een kaars.

Waarschuwing!



Gebruik geen kaars die brand!



Opgepast, de spieën zijn scherp!

Pictogrammen.



Opgelet! Controleer de goede positie.



Smeer het onderdeel in met kaarsvet.



Snijd dwarsstukken voordat u het onderdeel van het bord verwijdert.



Breek of snij het onderdeel uit.



Schuur om de bramen te verwijderen.



Reserveonderdelen.

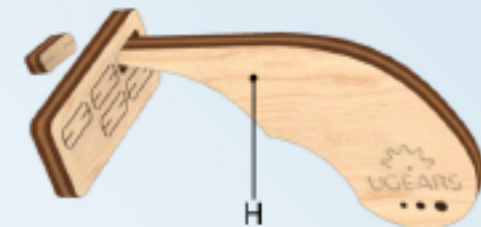
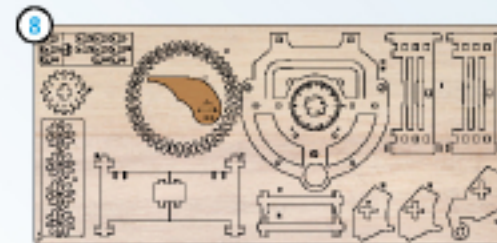

Dit is geen onderdeel. Het is een gereedschap voor meting en montage. Leder model heeft z'n eigen gereedschap.

1

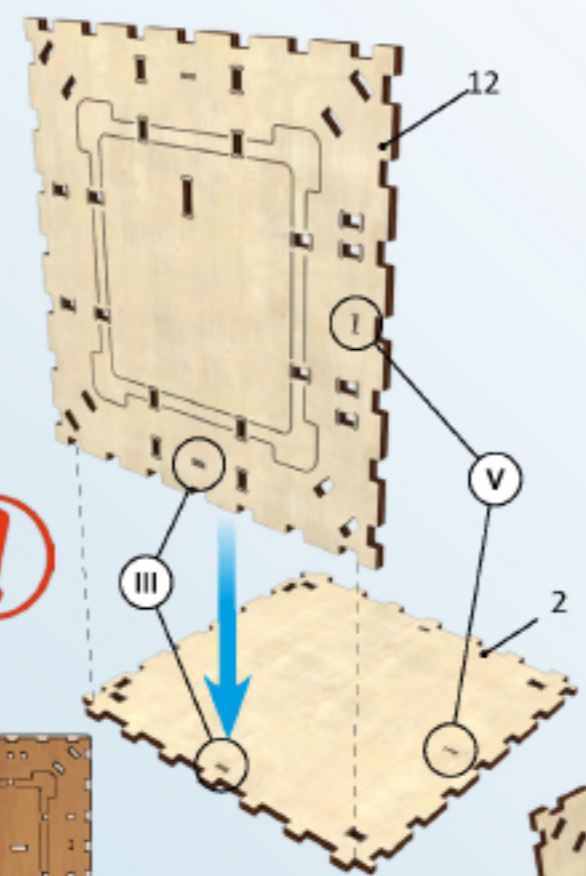

2

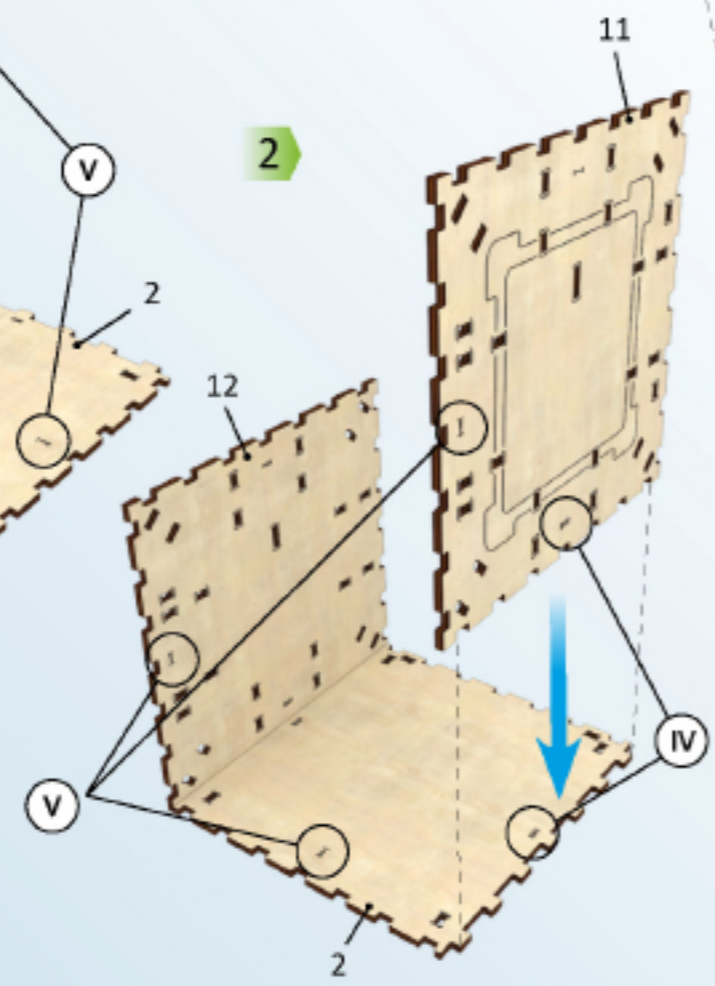

3

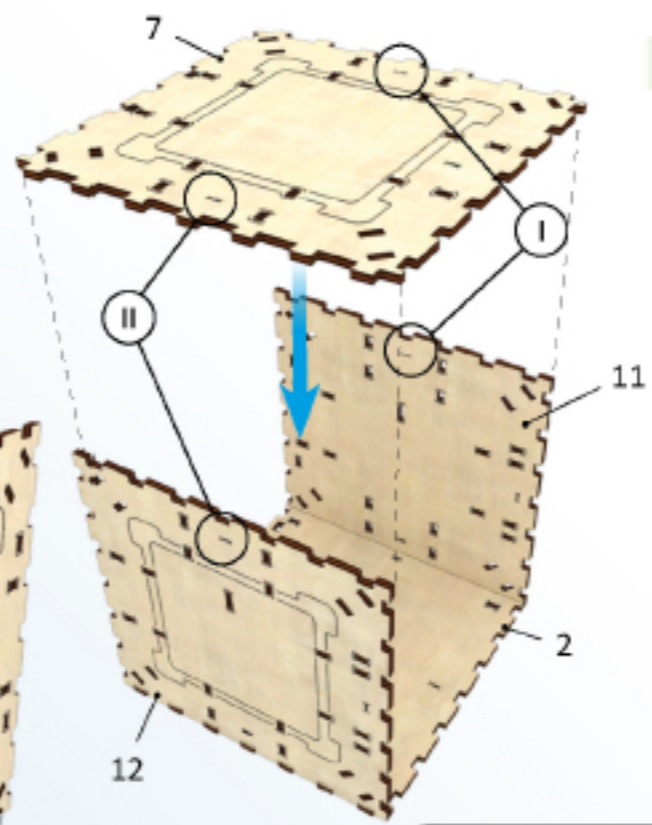

4

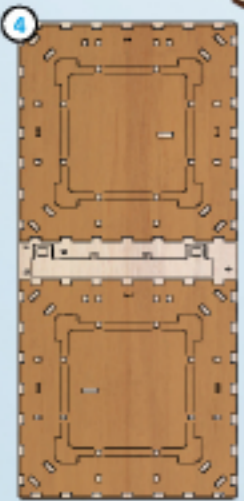
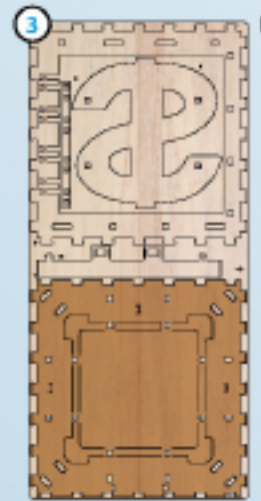
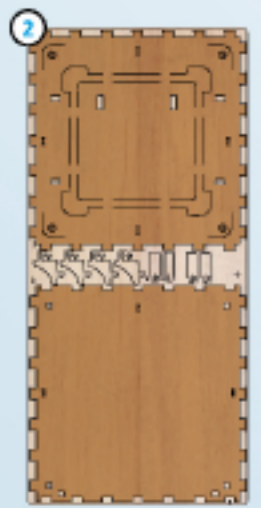
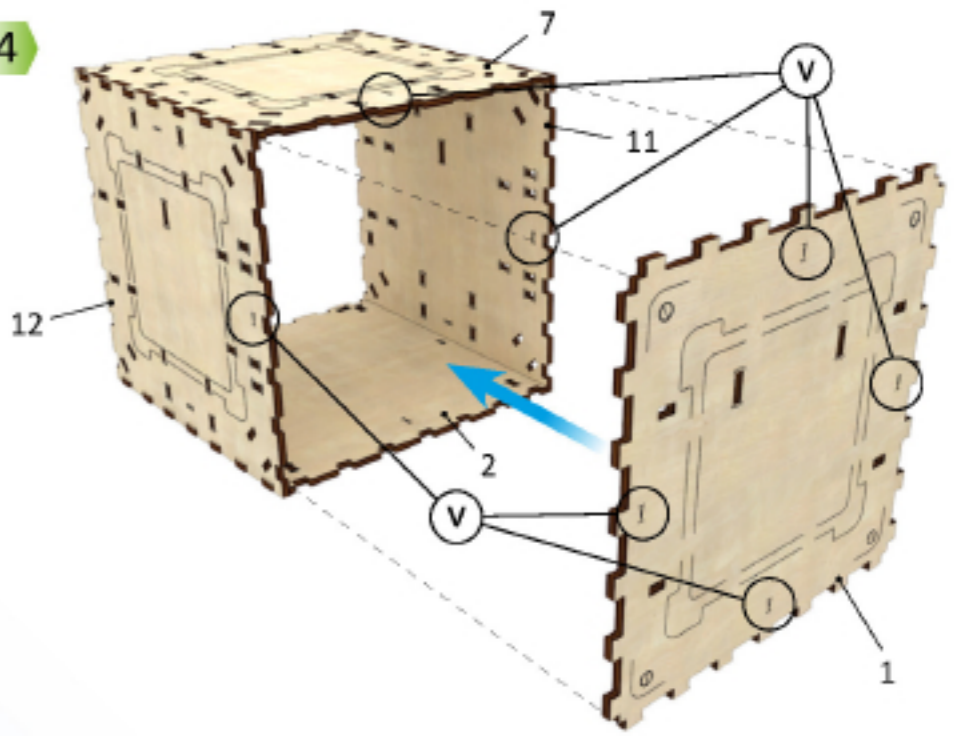

4

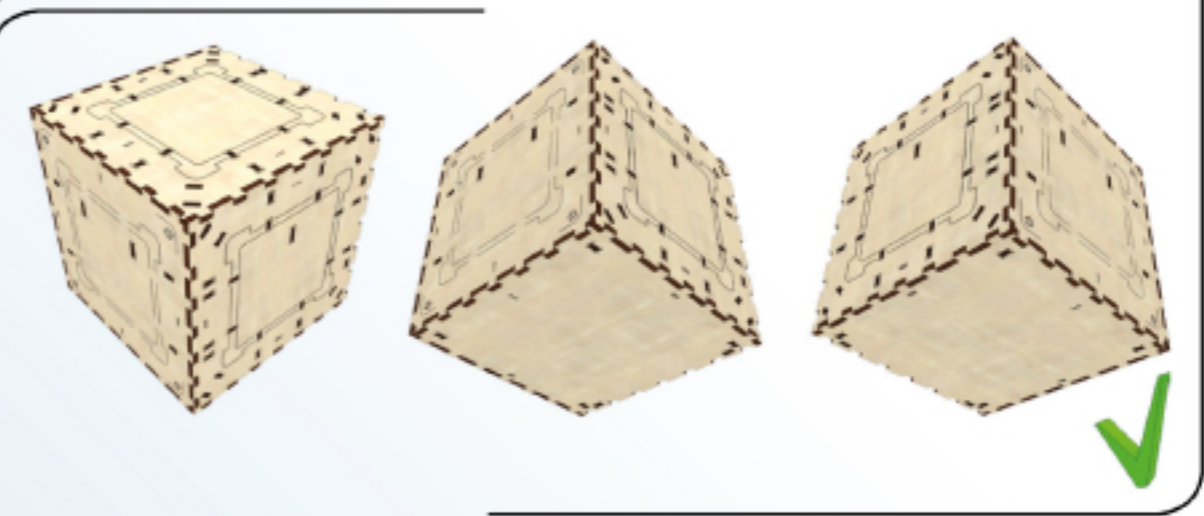

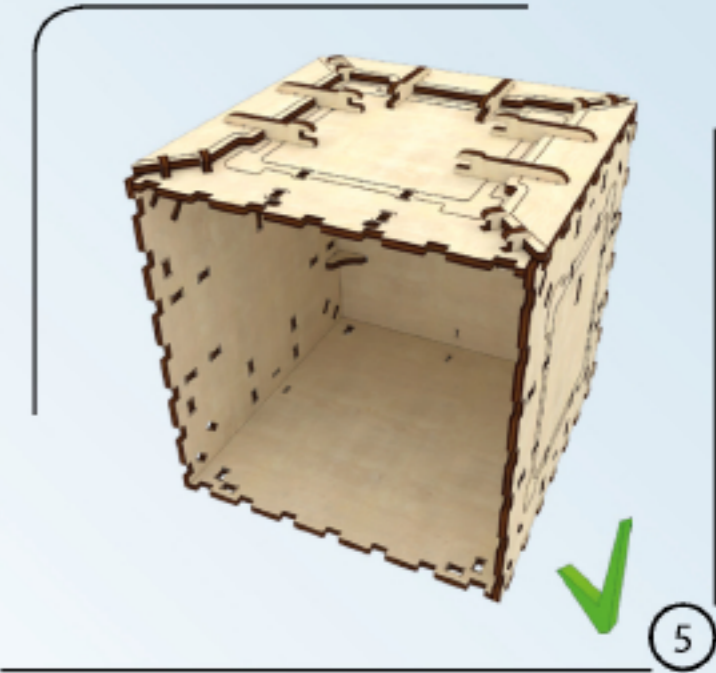
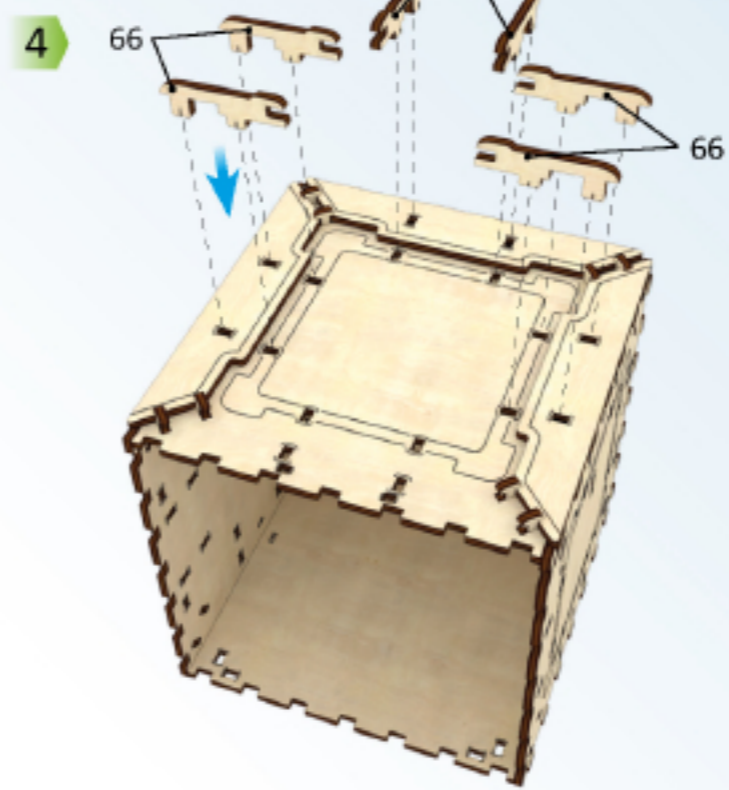
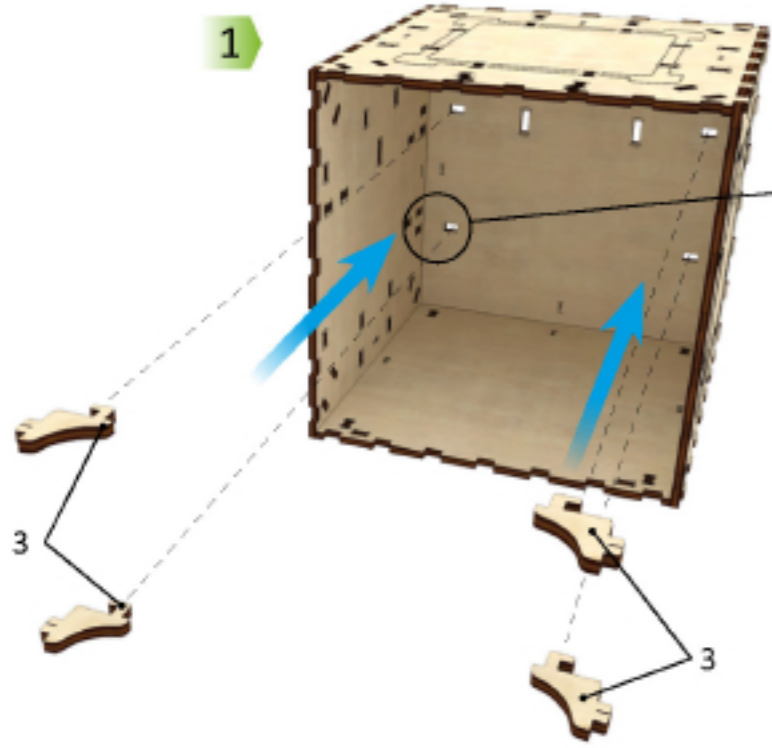
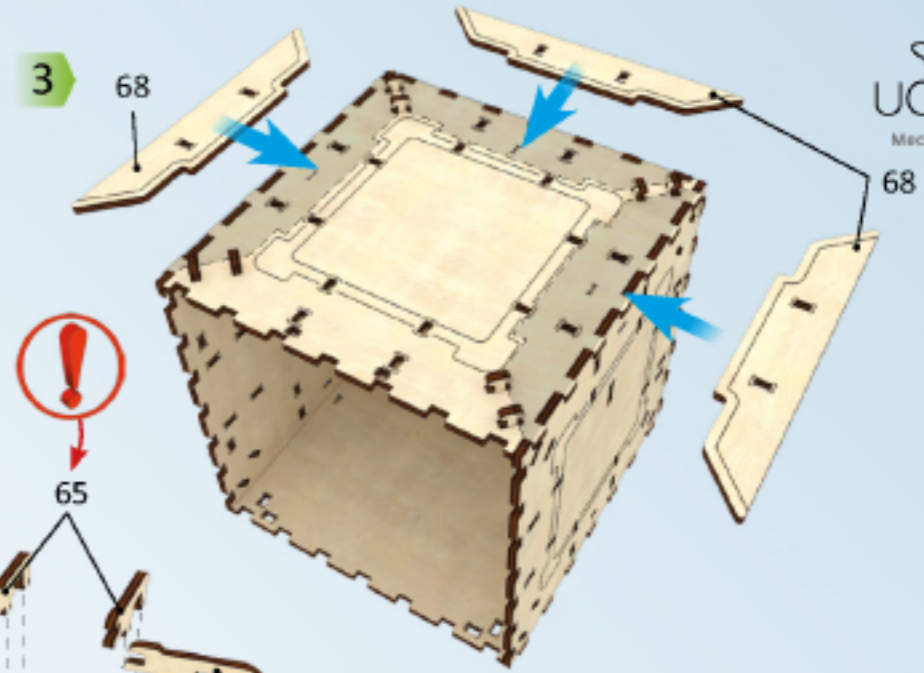
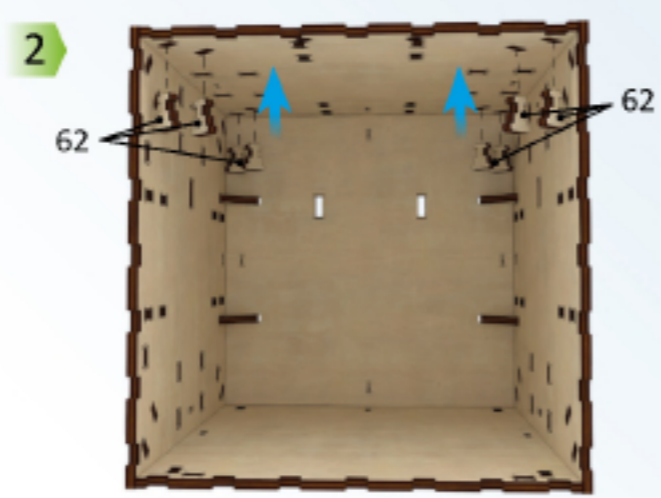
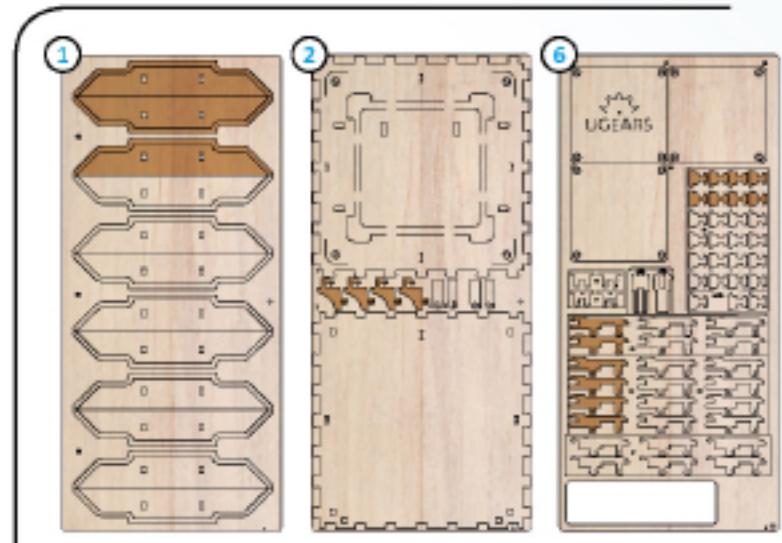

Mechanical models

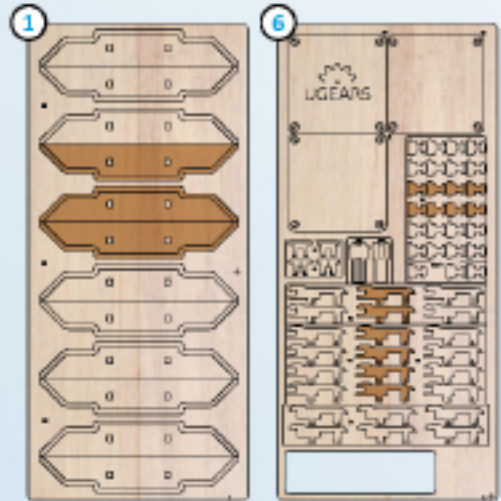

2

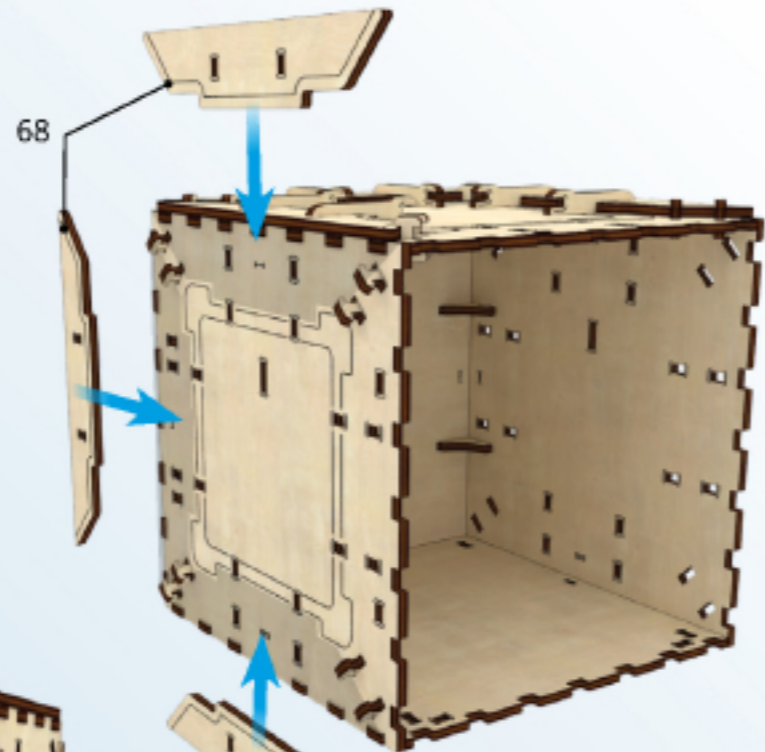

4

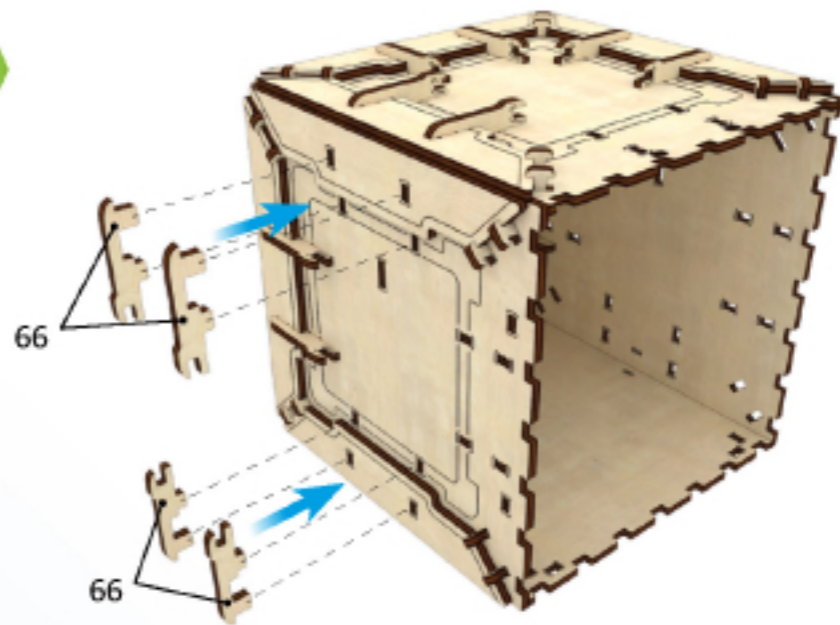

1

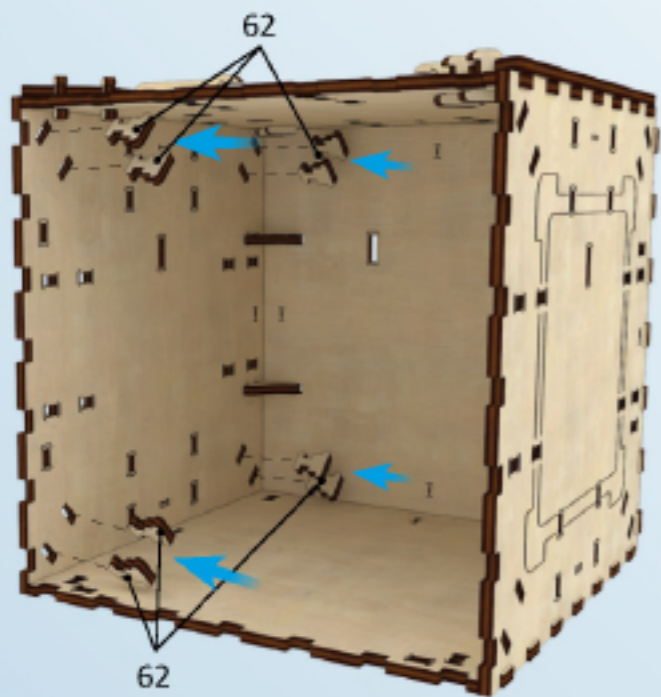

3



6

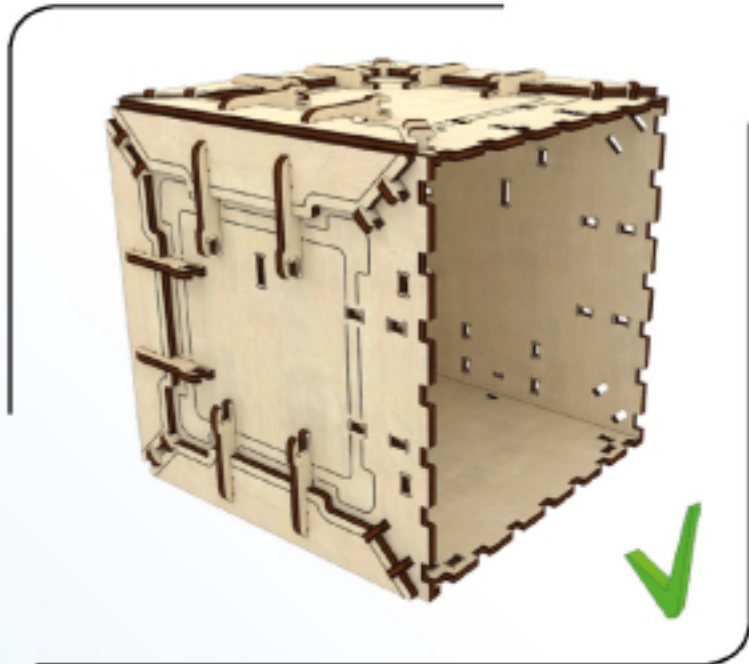

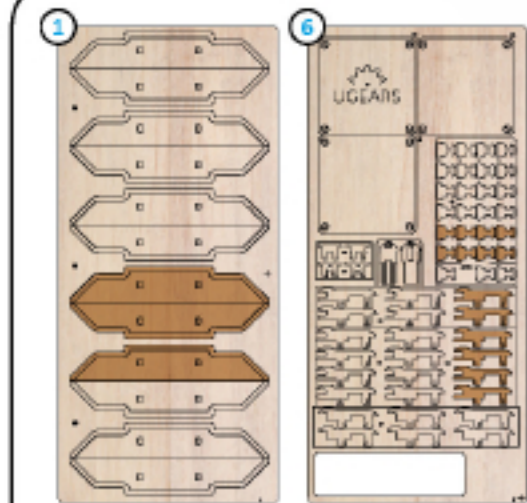

1

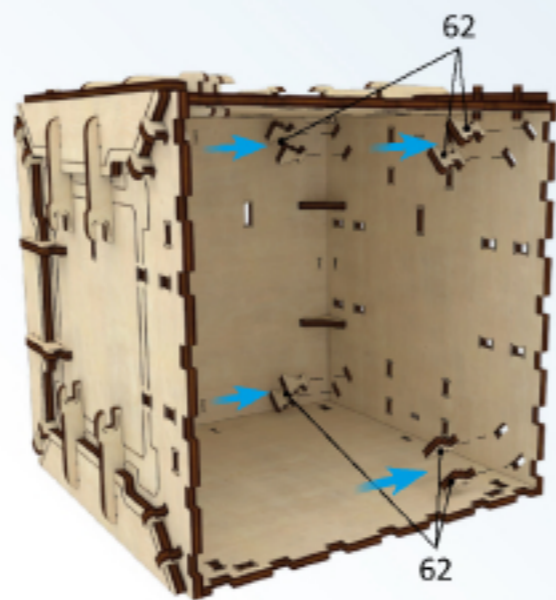

2

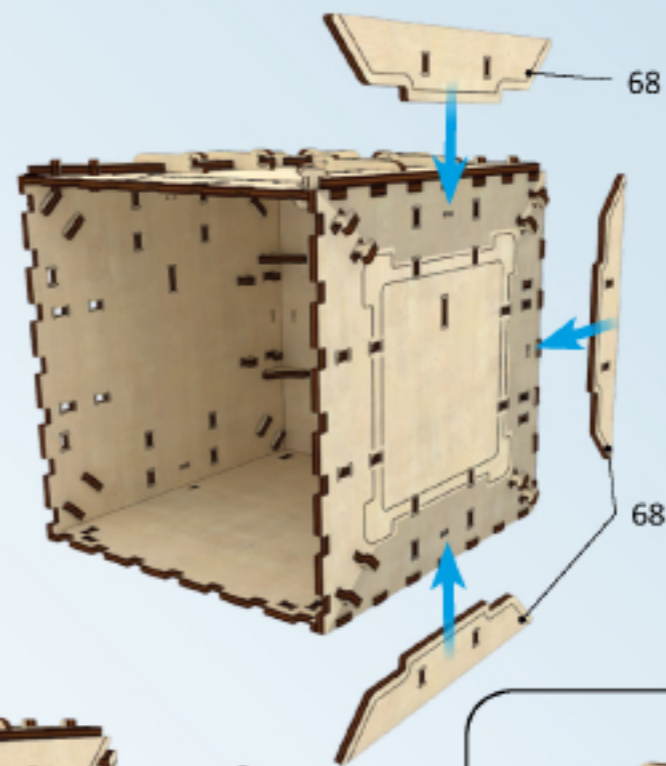

3

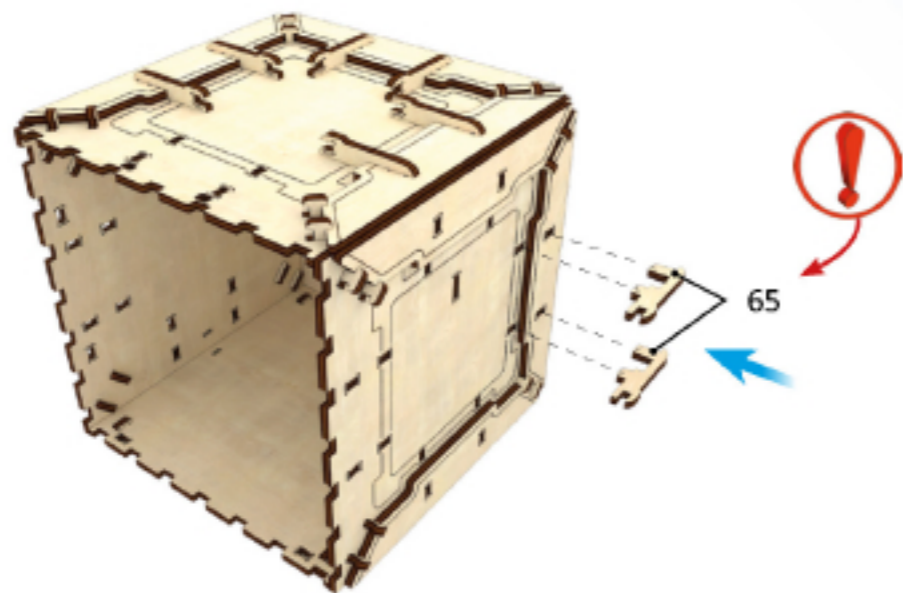

4

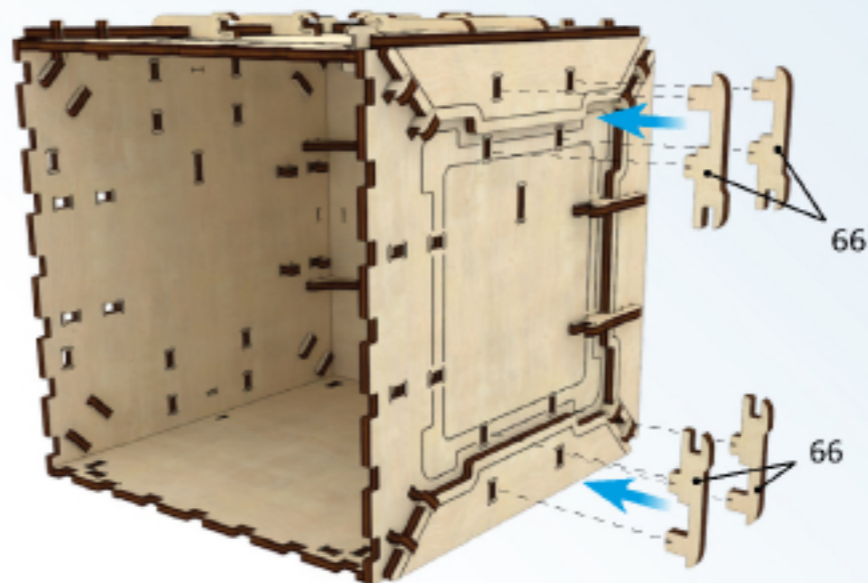

Mechanical models

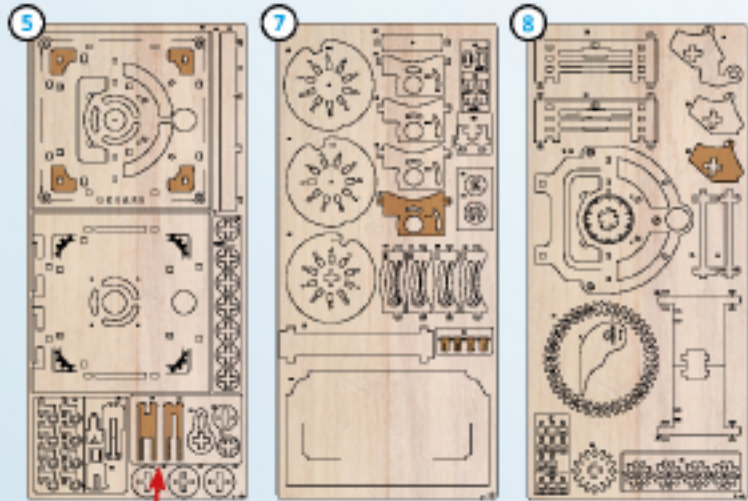

8

1

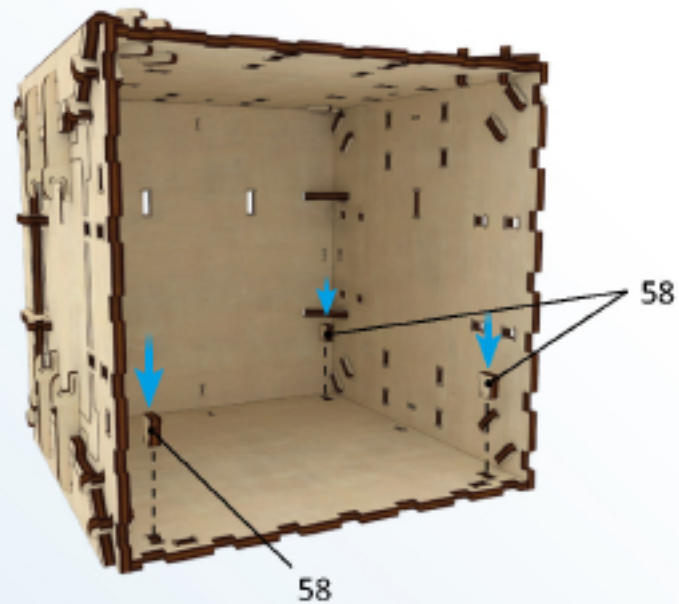

2



3

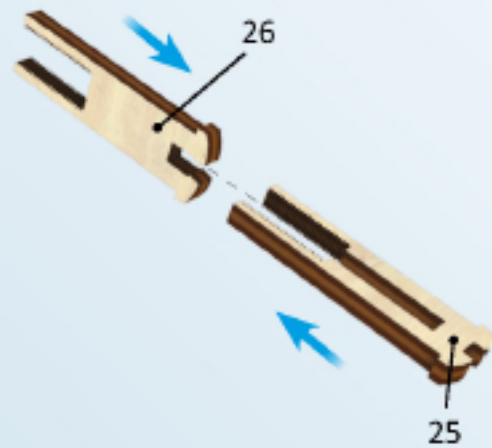

4

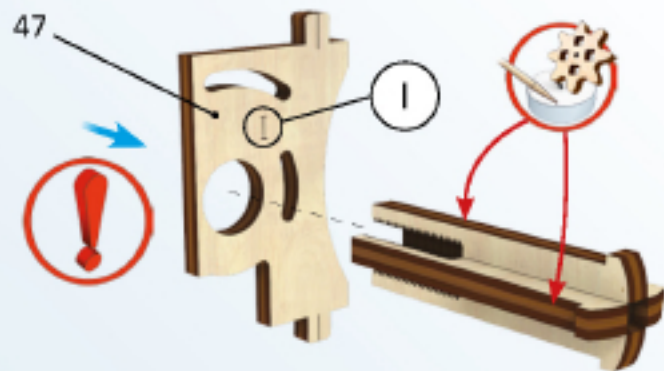

5

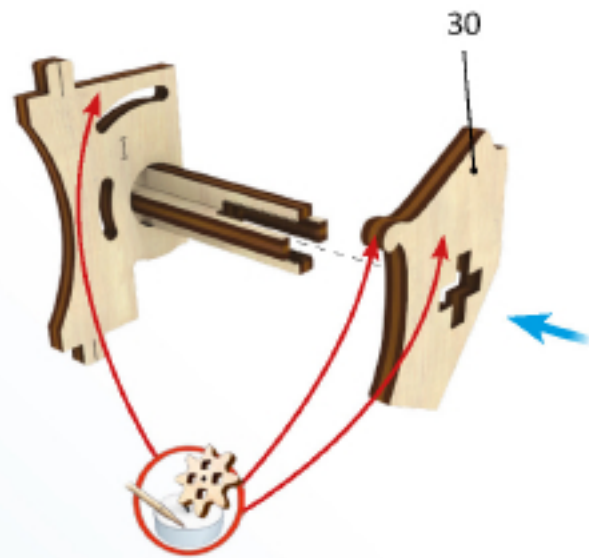

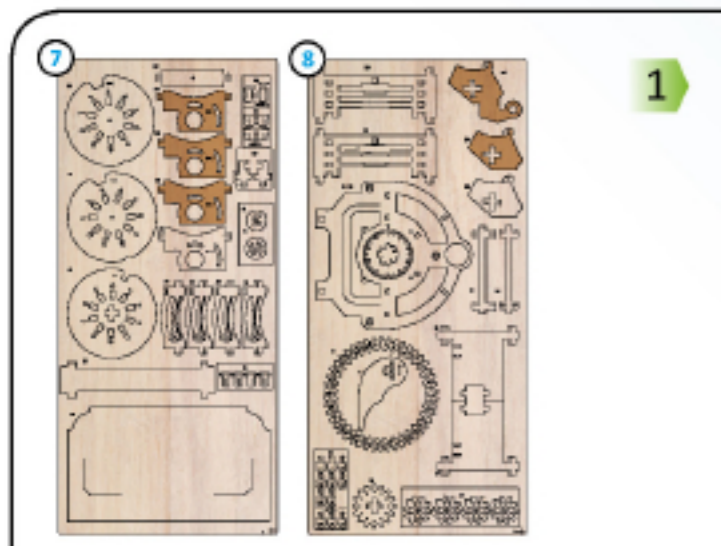

1

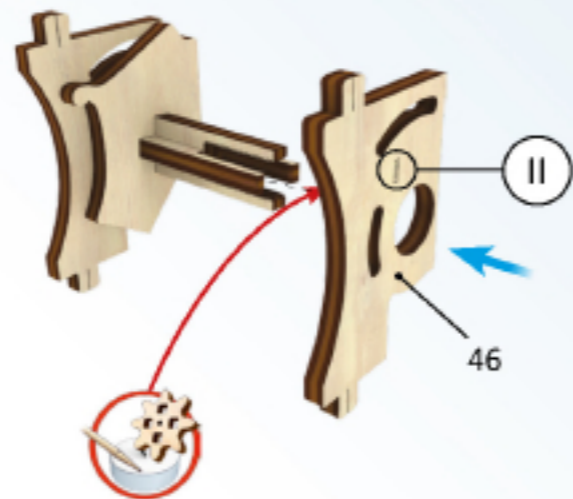

2

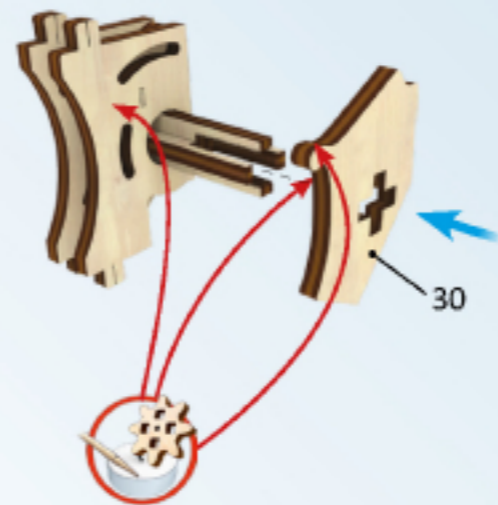

3

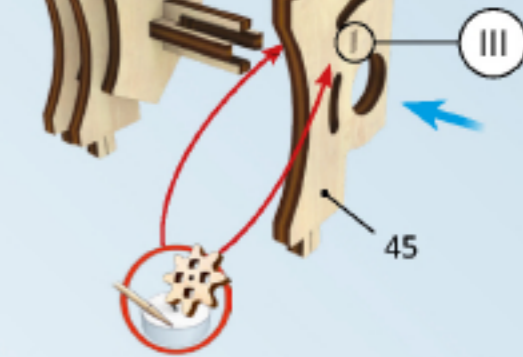

4

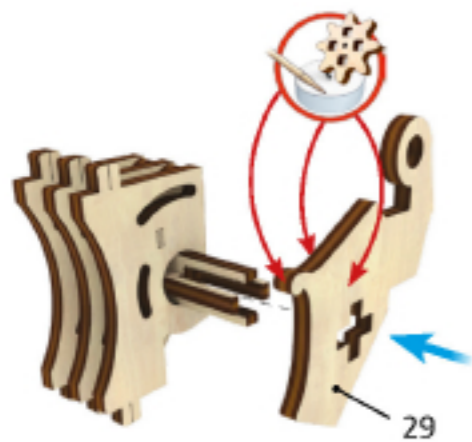

5

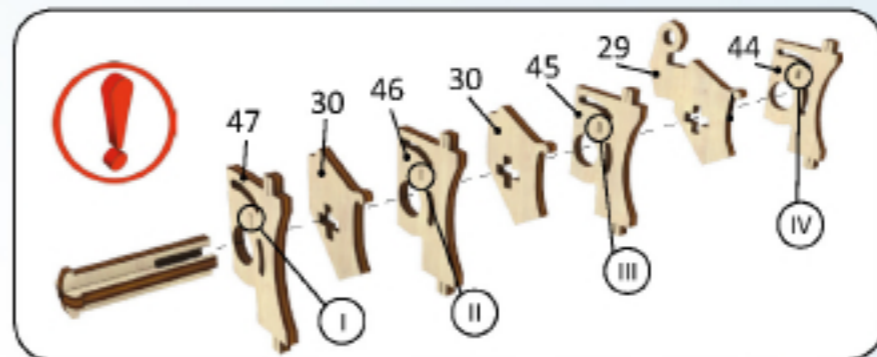
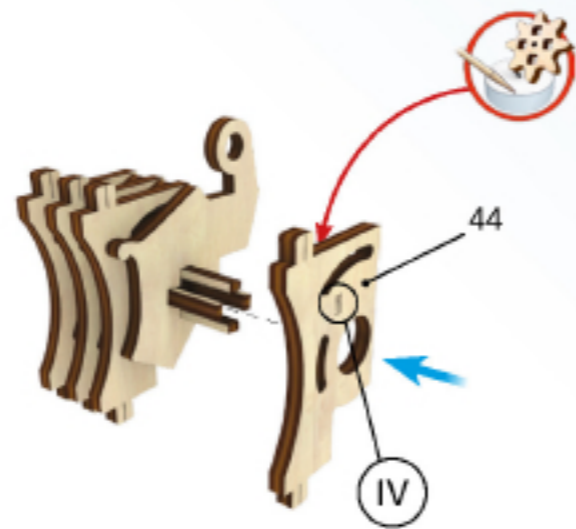

9

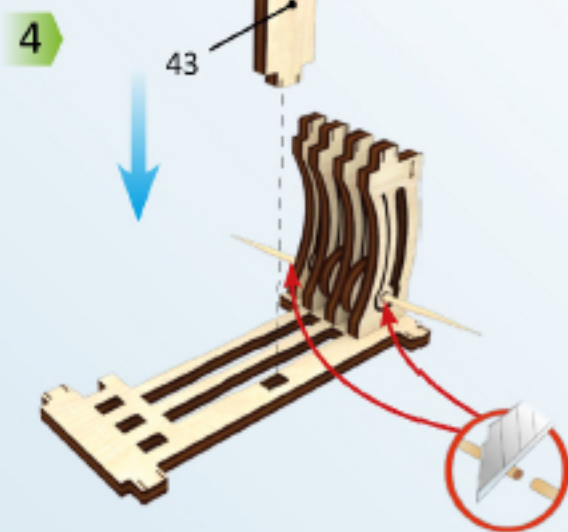
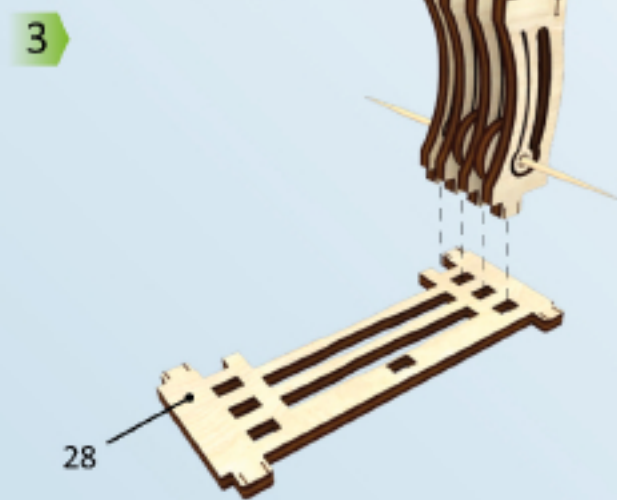
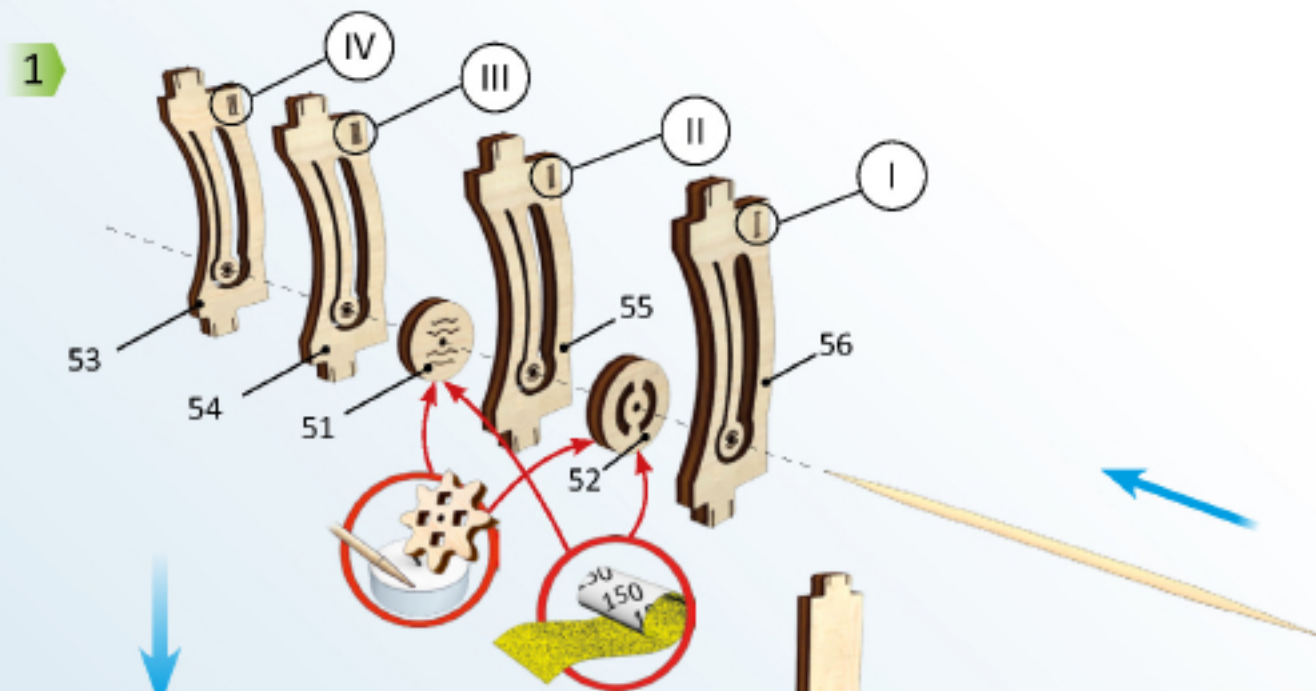
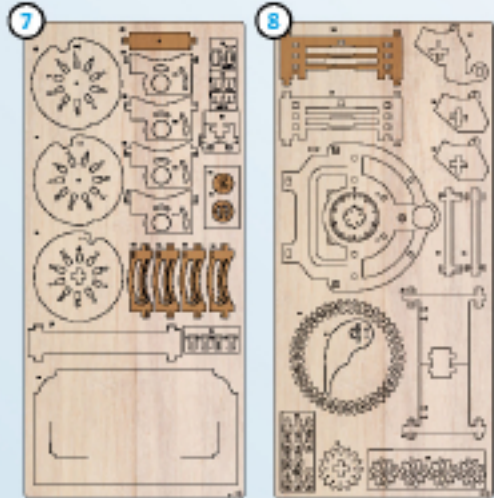

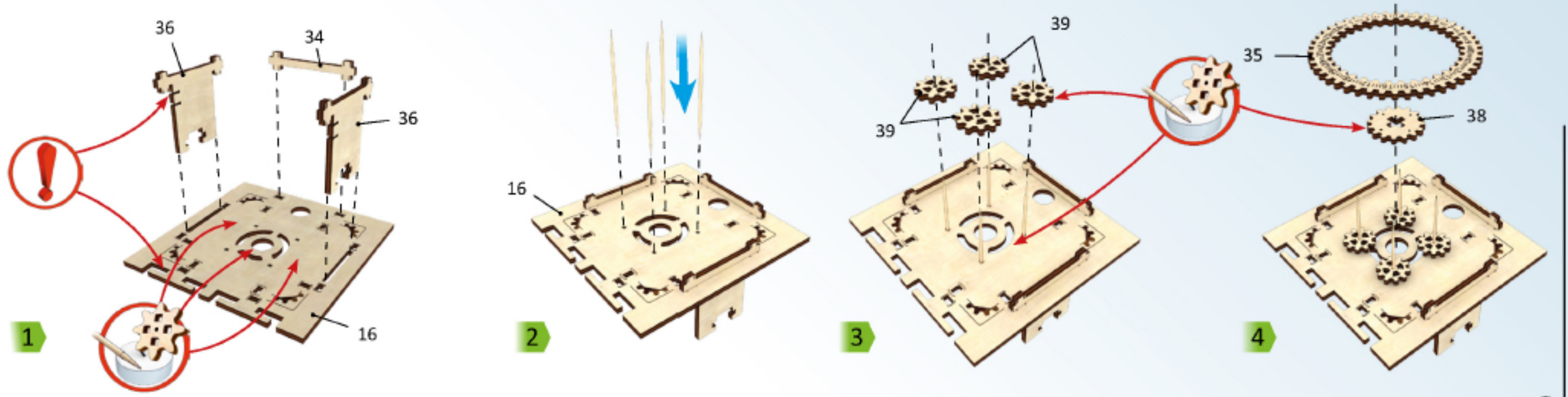
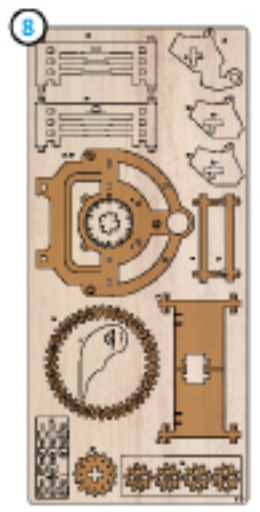
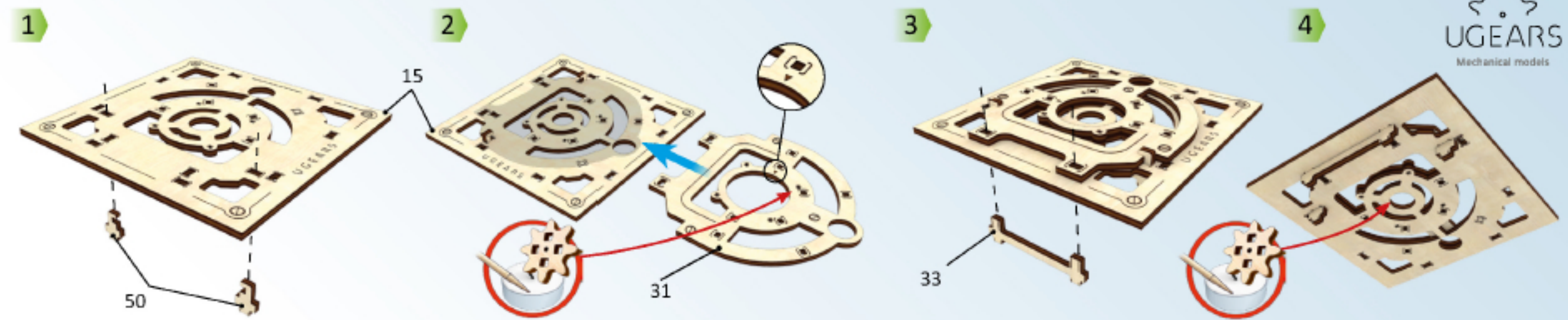
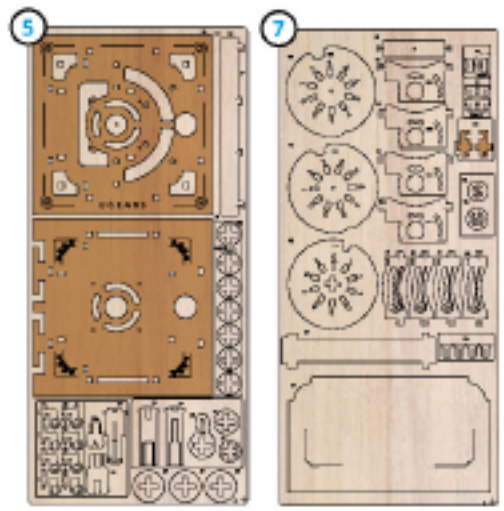



1



2

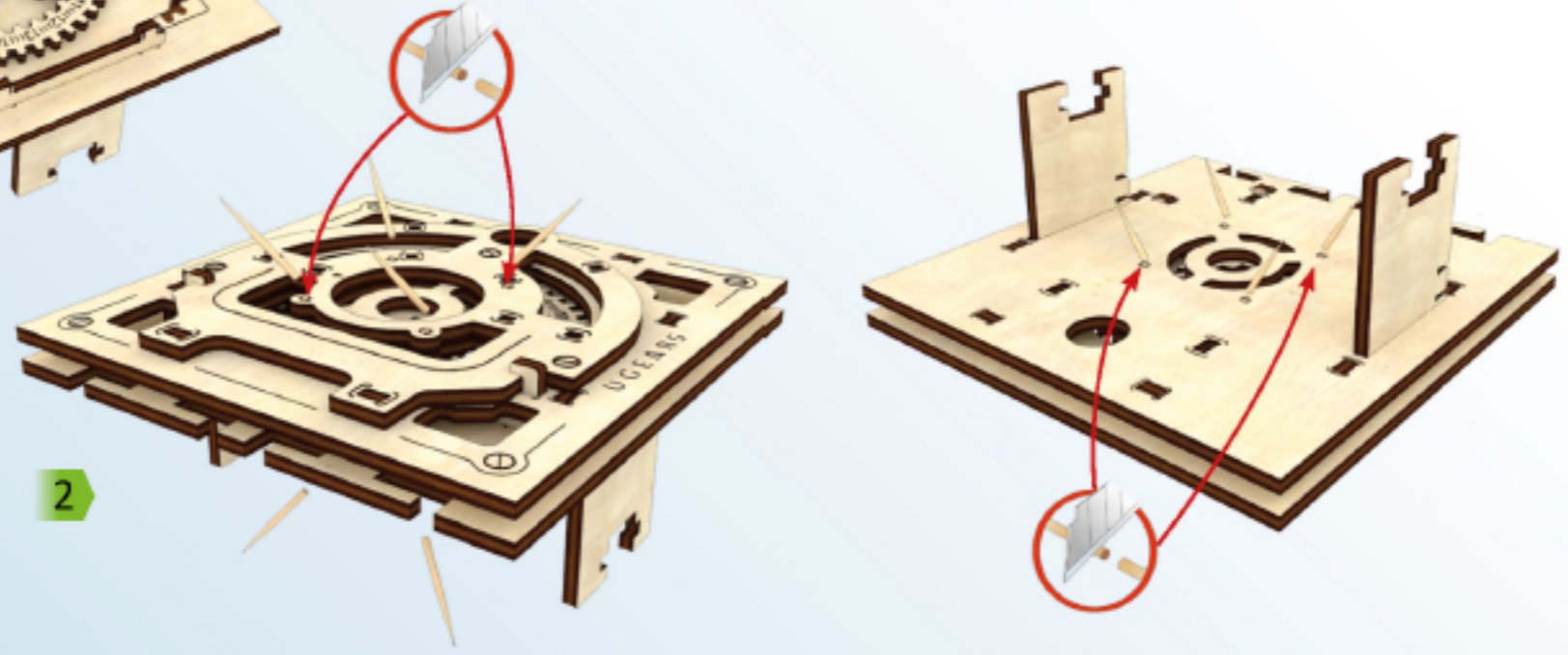

1

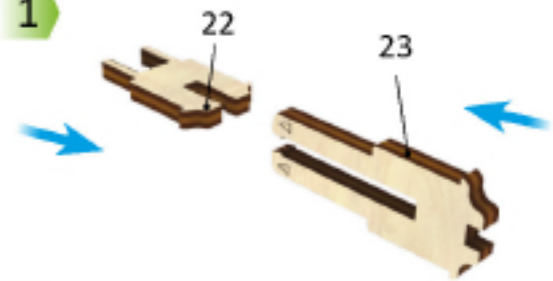

2

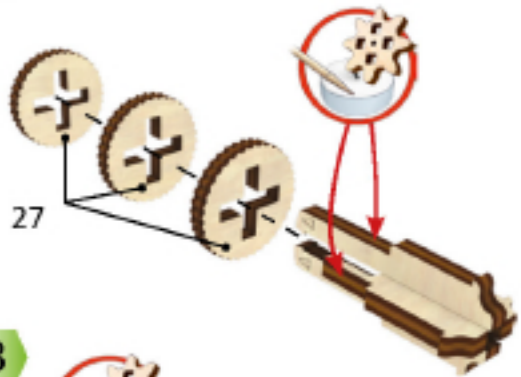

3

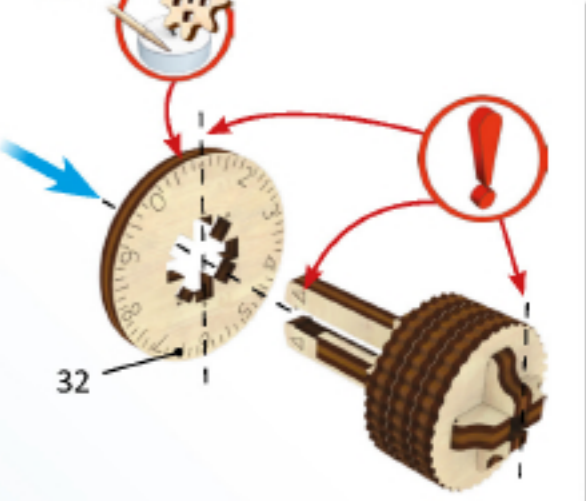

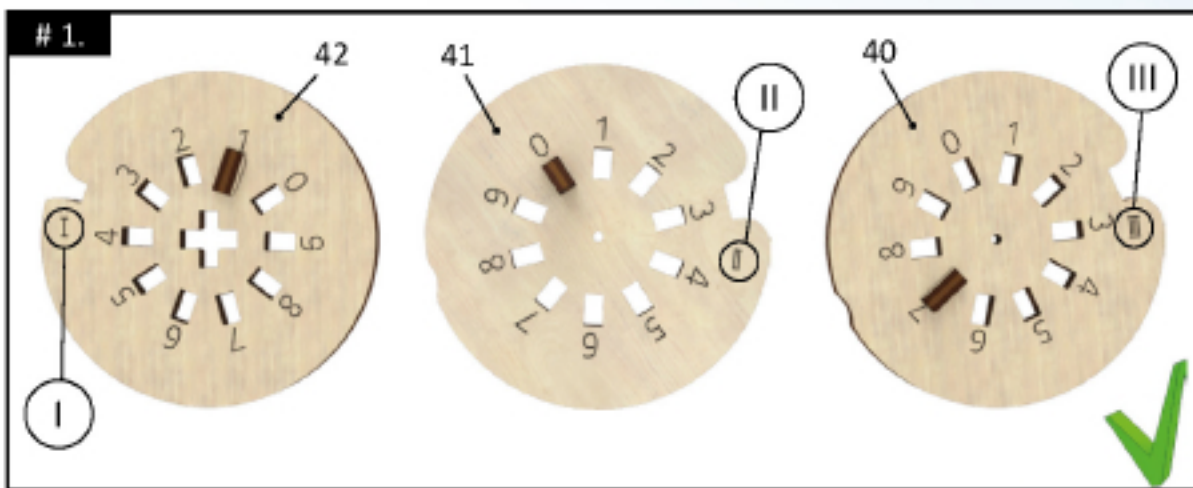

	I	II	III	T 1.
				CODE
1	1	0	7	321
1	9	6	2	641
2	9	4	1	872
6	3	2	9	876

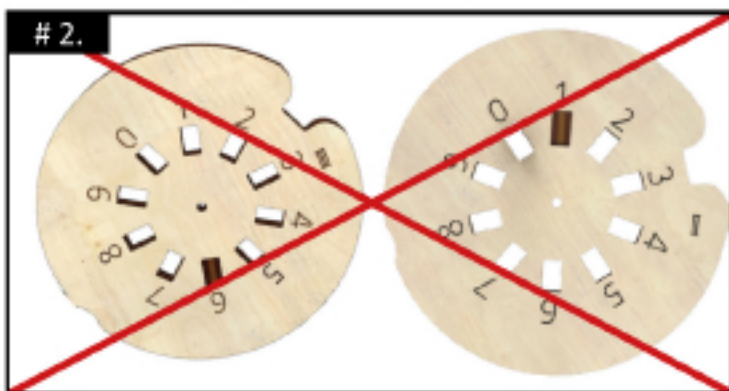

Toelichting.

De kluis wordt geassembleerd met een standaard combinatieslotcode 321. Om een andere code in te stellen, moet u tijdens de montage de pinnen 48 en 49, in drie grote ringen met de labels 40, 41 en 42 in de sleuven, vervangen door andere getallen. Zie afb. 1. U kunt code-instellingsopties vinden in tabel 1.

Let op! Plaats geen pinnen in de ringen I, II, III in sleuven met tegenovergestelde nummers. Bijvoorbeeld 1 en 4, of 4 en 9. Zie fig. 2.

Het laatste cijfer van de code hangt af van hoe de knop wordt vergrendeld in het gat van onderdeel 32 en daarna in de deur van de kluis. De juiste positie voor installatie is gemarkeerd op onderdeel 32 met pijlen en cijfers 1-6 en 2-7. Installeer de vergrendelknop niet in een gleuf zonder pijlen. Zie fig.3

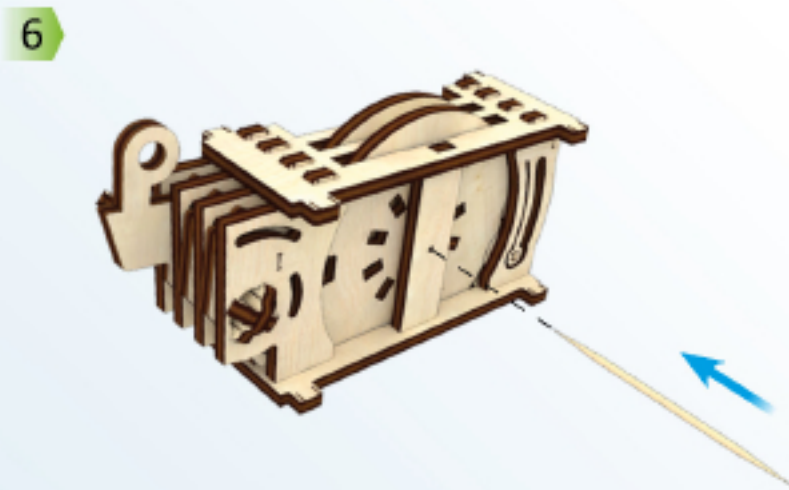
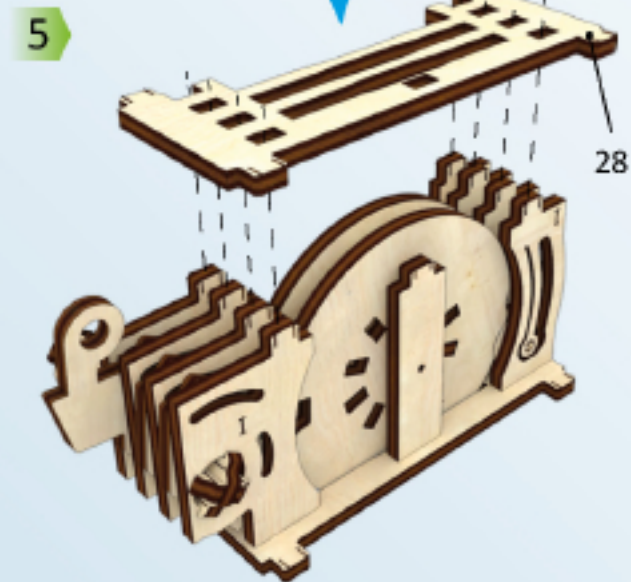
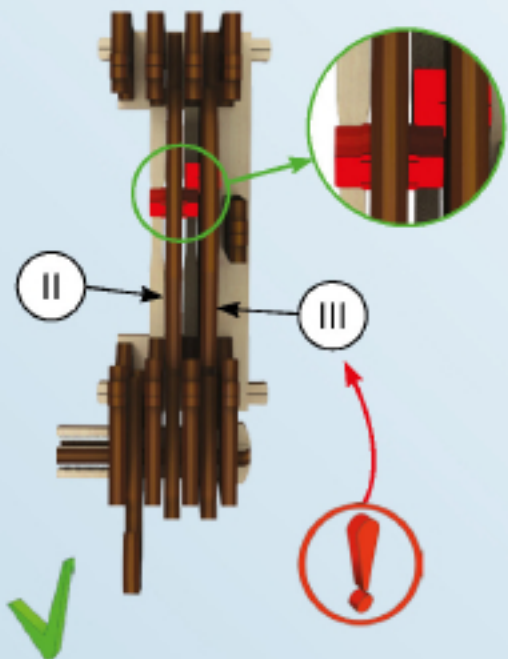
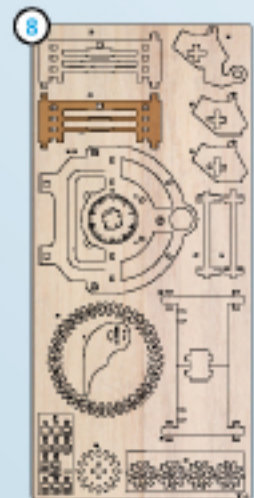
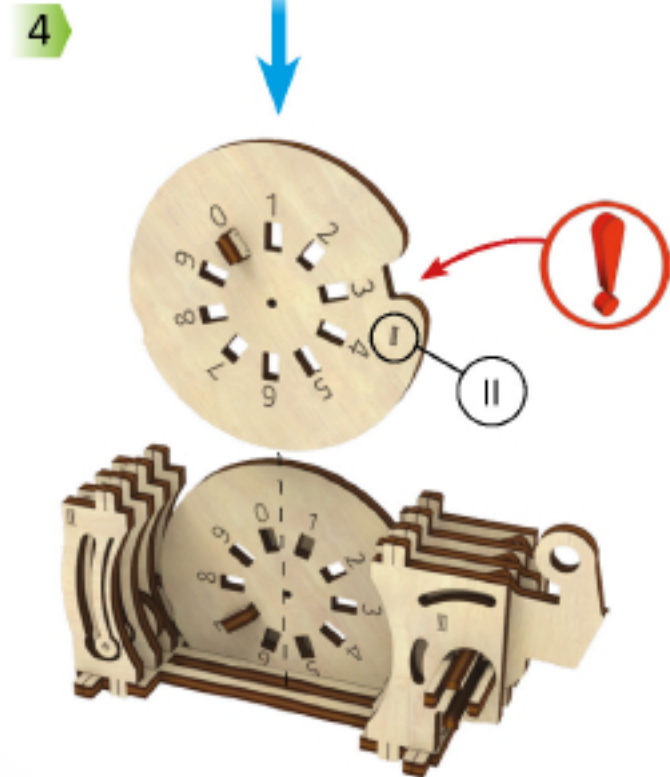
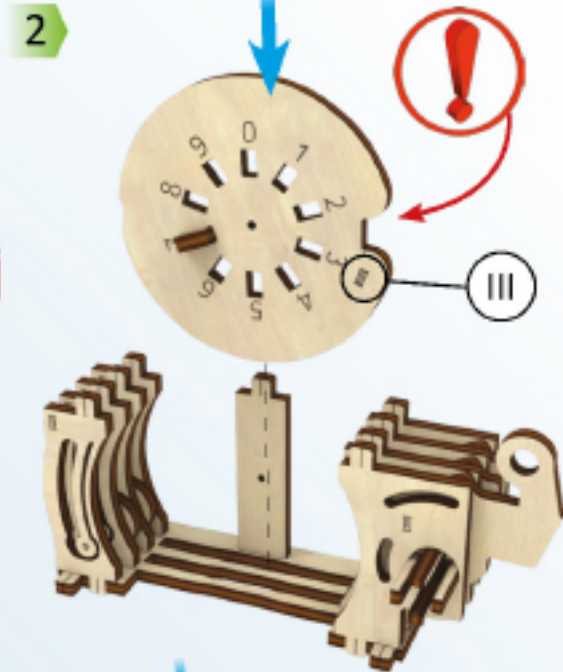
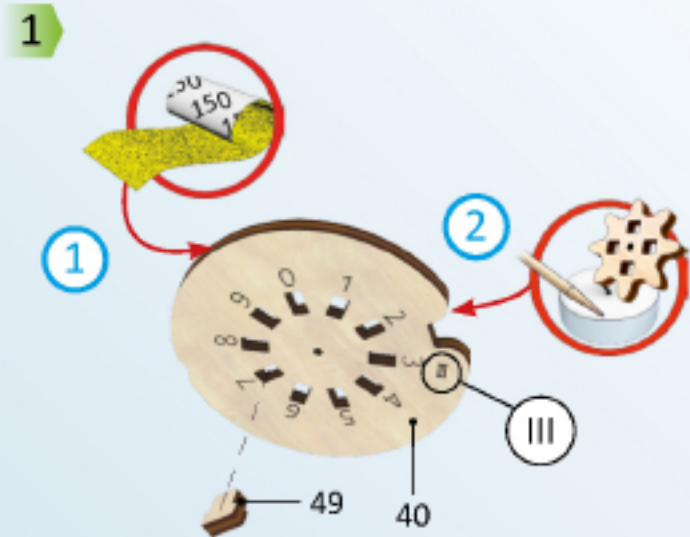
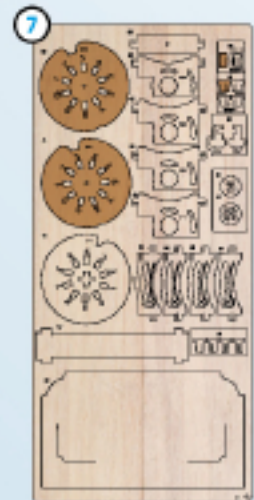

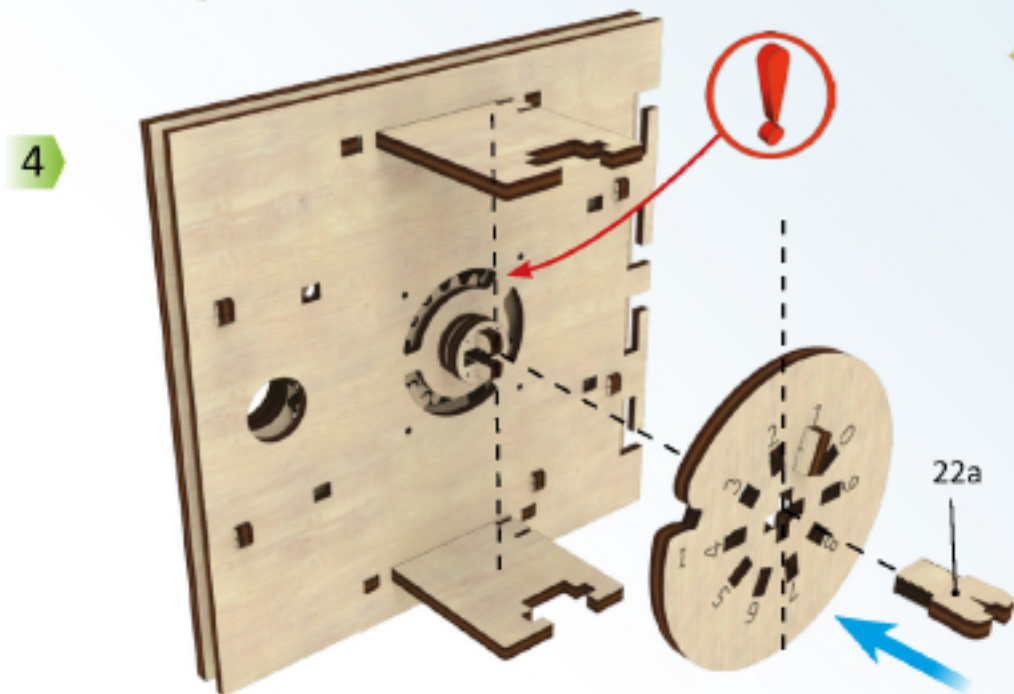
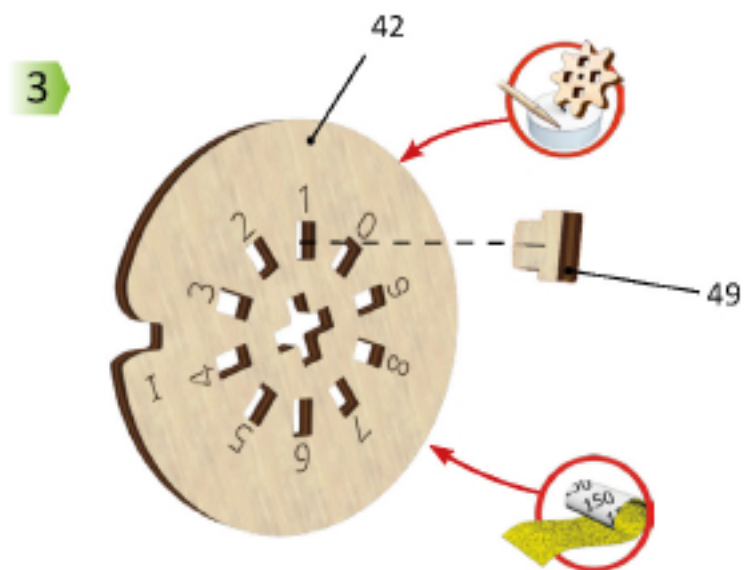
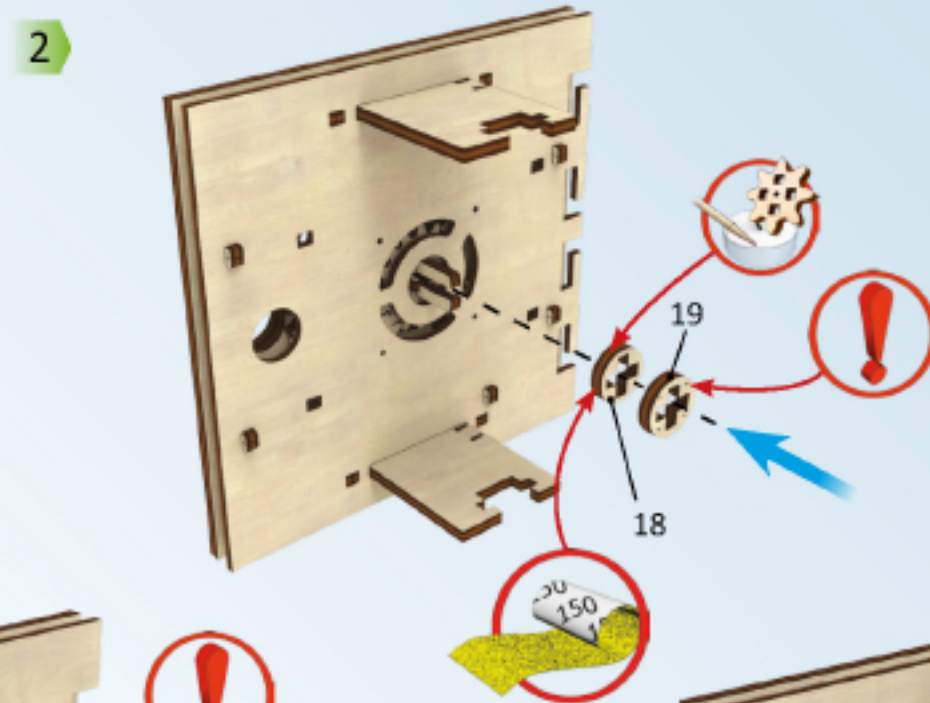
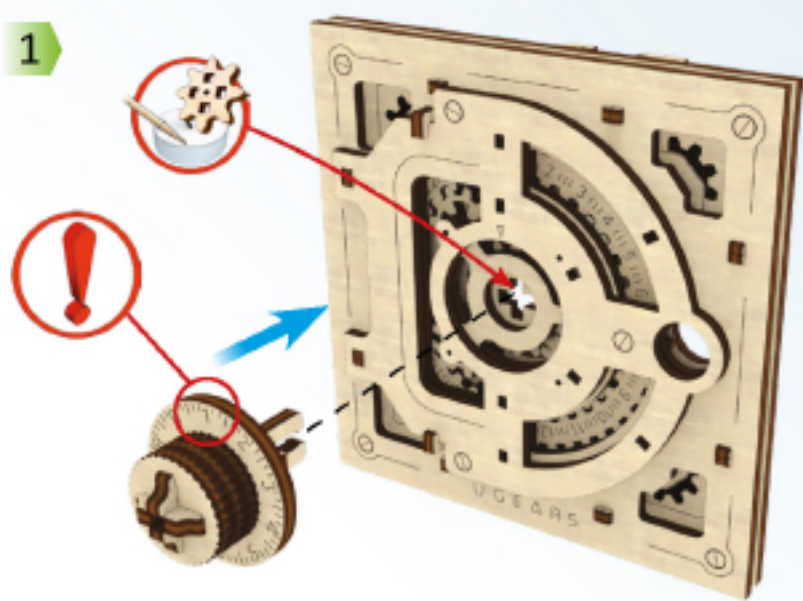
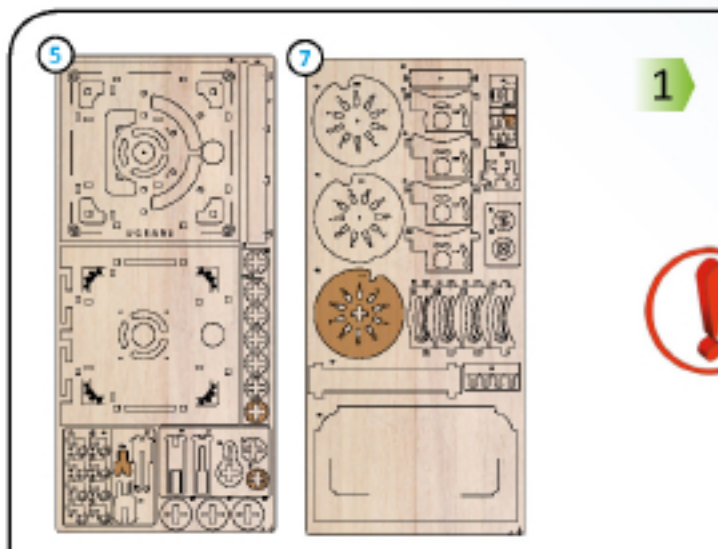

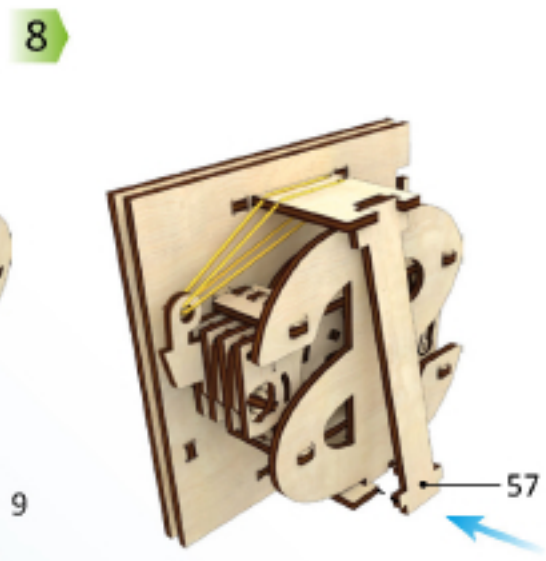
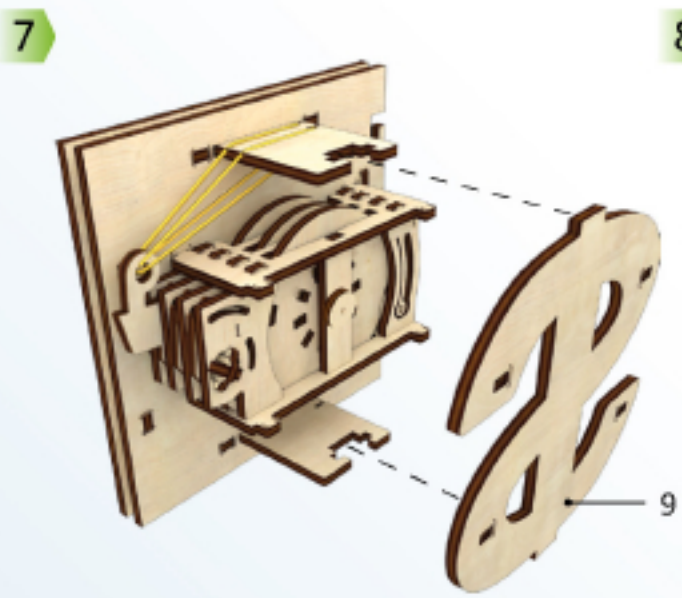
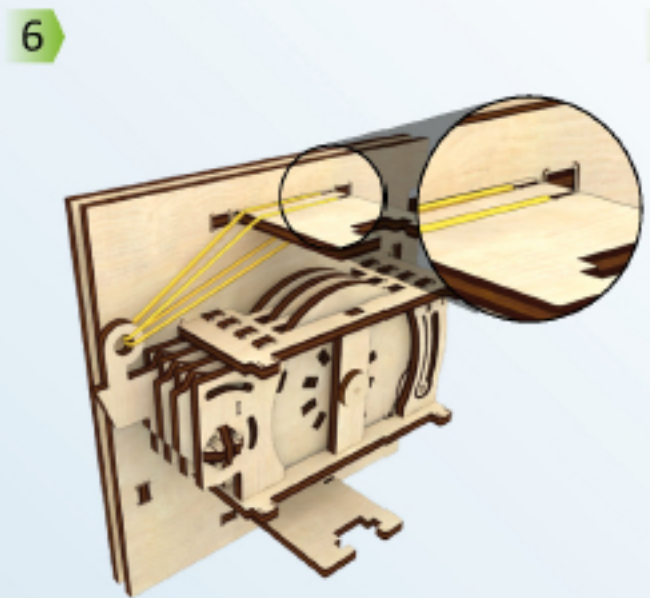
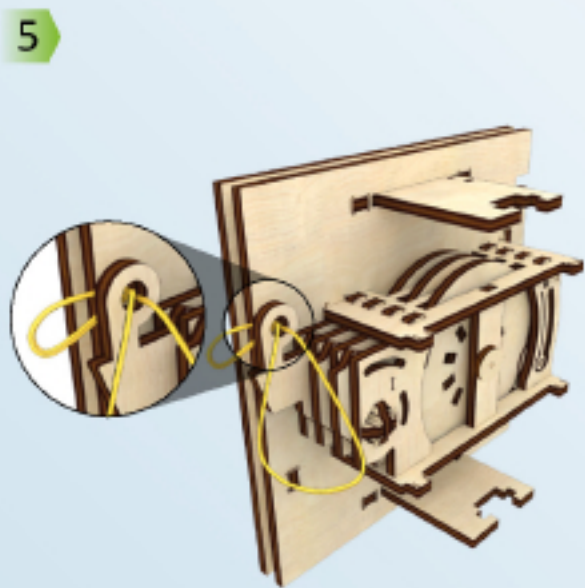
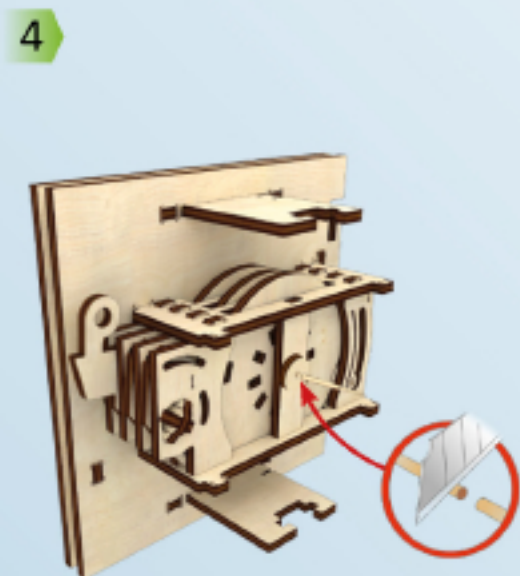
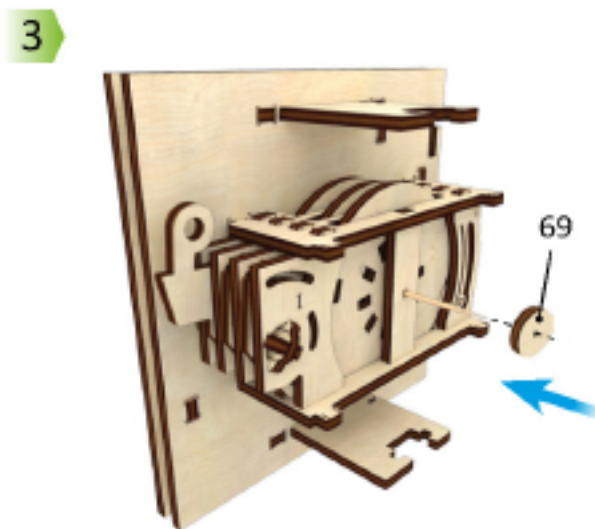
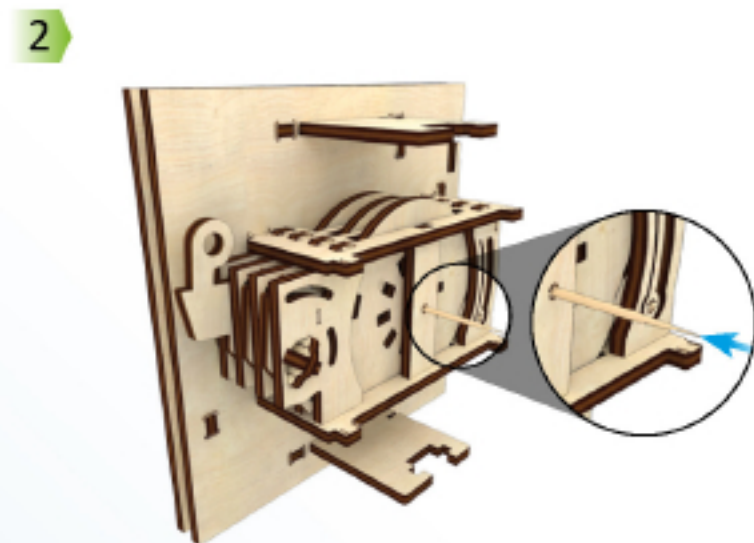
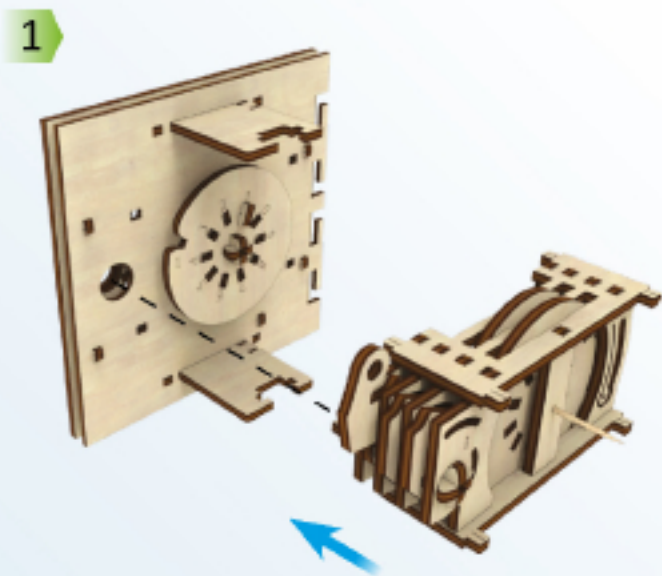
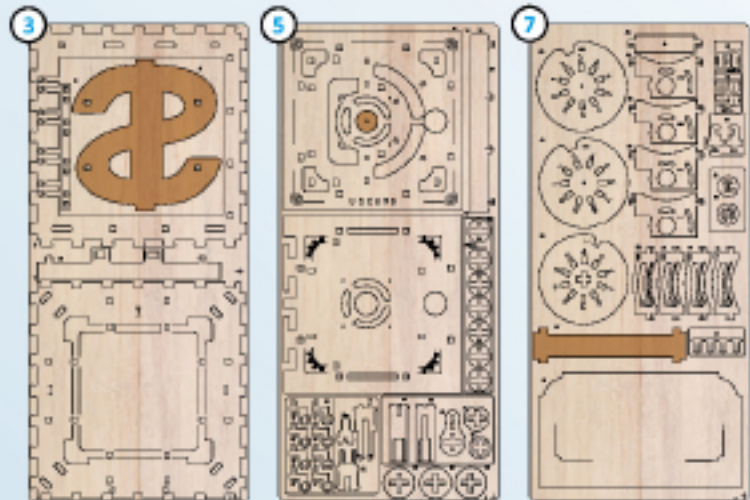

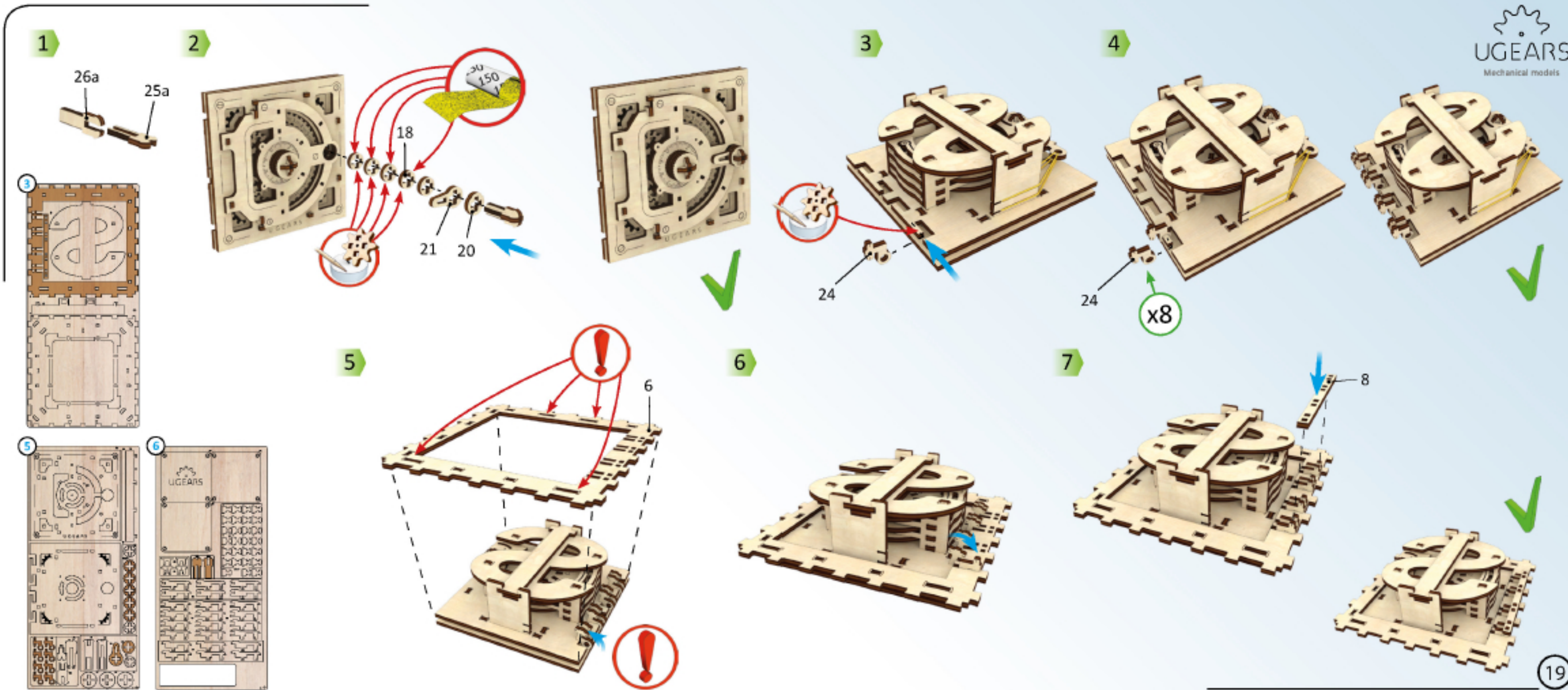

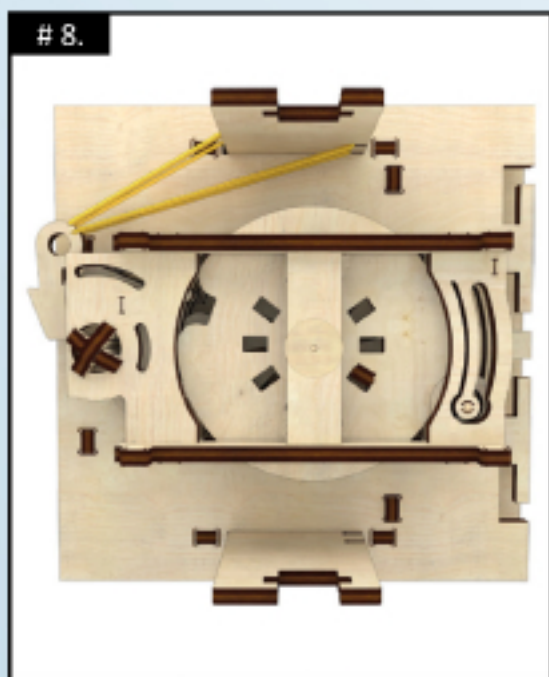
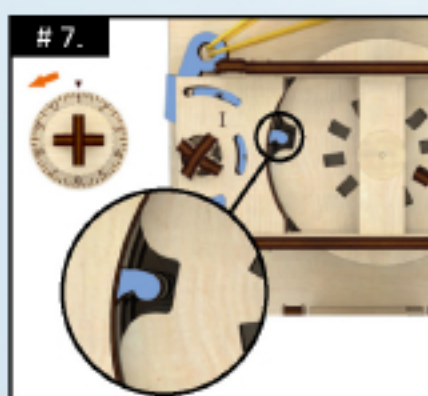
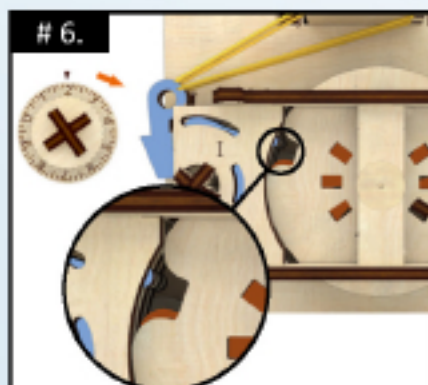
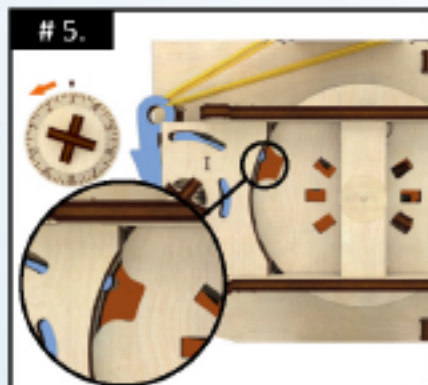

Na de assemblage van het slot moet u de feitelijke code vinden die tijdens het assembleren is geconfigureerd. Begin door de vergrendelknop twee keer linksom te draaien (links). Doe dit elke keer voordat u de code invoert.

Eerste cijfer. Draai de vergrendelknop linksom (links) totdat de gleuf op de laatste (derde) schijf is uitgelijnd met de knop op het vergrendelingsmechanisme. Kijk naar het cijfer in de knop waar het driehoekje naar wijst. Onthoud het cijfer. Afb.5.

Tweede cijfer.

Draai de vergrendelknop rechtsom (rechts) naar nul. Draai bij het bereiken van nul verder totdat de gleuf op de tweede schijf is uitgelijnd met de knop op het vergrendelingsmechanisme. De tweede schijf is rood gemarkeerd. Kijk naar het cijfer op de knop waarnaar het markeringsteken verwijst. Onthoud het cijfer. Fig 6.

Derde cijfer. Draai de veilige knop nogmaals linksom (links) totdat het slot opengaat. De eerste schijf is groen gemarkeerd. Kijk naar het cijfer op de knop waar het driehoekje naar wijst. Onthoud het cijfer. Fig 7.

Wanneer de slots op alle drie de schijven zijn uitgelijnd met het vergrendelingsmechanisme, wordt het slot geopend. Afb.8.

Draai de knop linksom (links) om het slot te sluiten. Controleer de slotcode een paar keer en kijk naar de cijfers op de slotknop. De code van een correct gemonteerd slot mag alleen hele getallen bevatten (bijvoorbeeld niet 7,5 of 3,5).

Let op! Sluit na het monteren van het slot de kluis deur NIET voordat u hebt gecontroleerd of de slotcode correct werkt. Sluit de deur pas nadat het slot volledig is gemonteerd met alle geïnstalleerde onderdelen, inclusief het dollartekenvormige achterframe en de bevestigingsstang 57. Fig. 4.

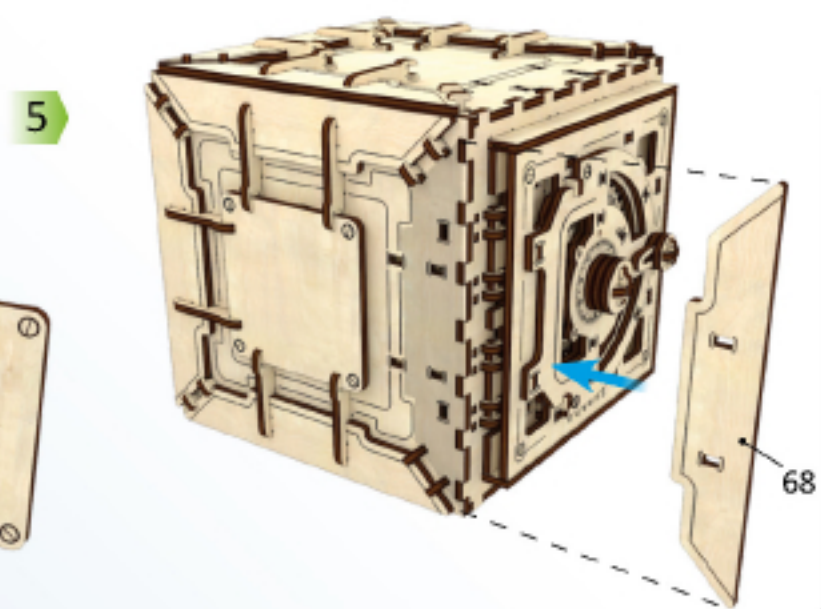
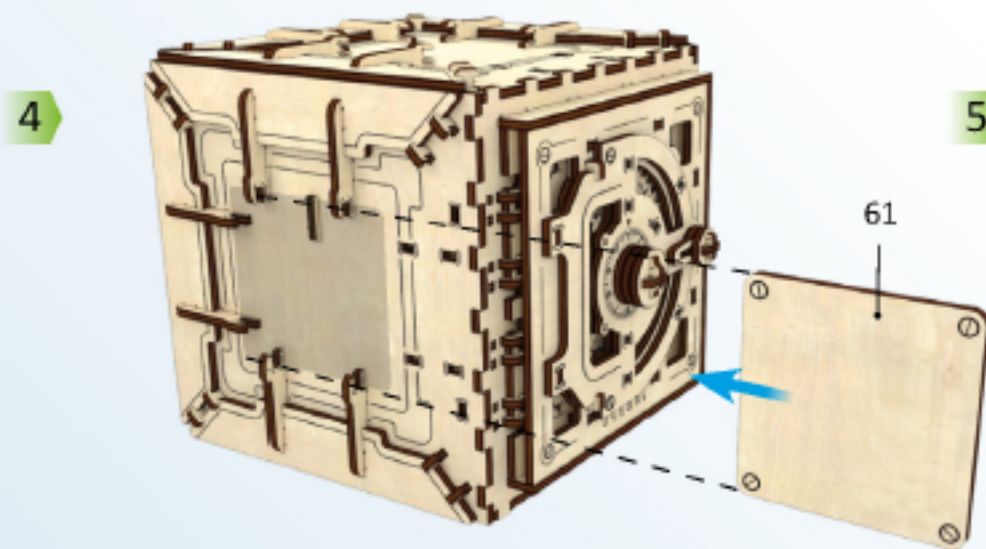
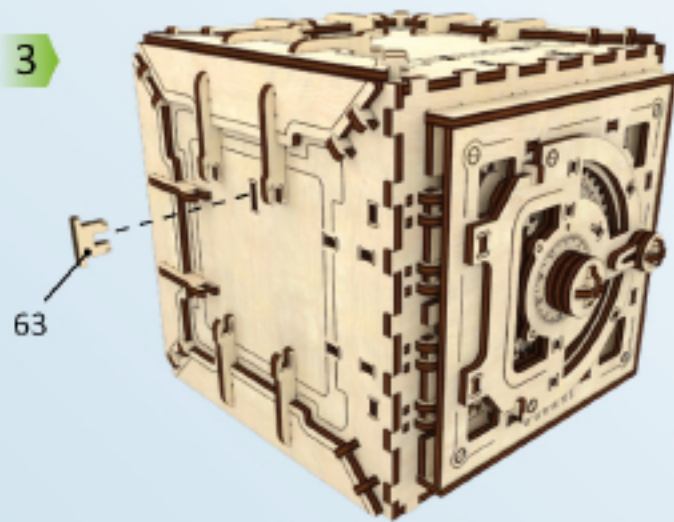
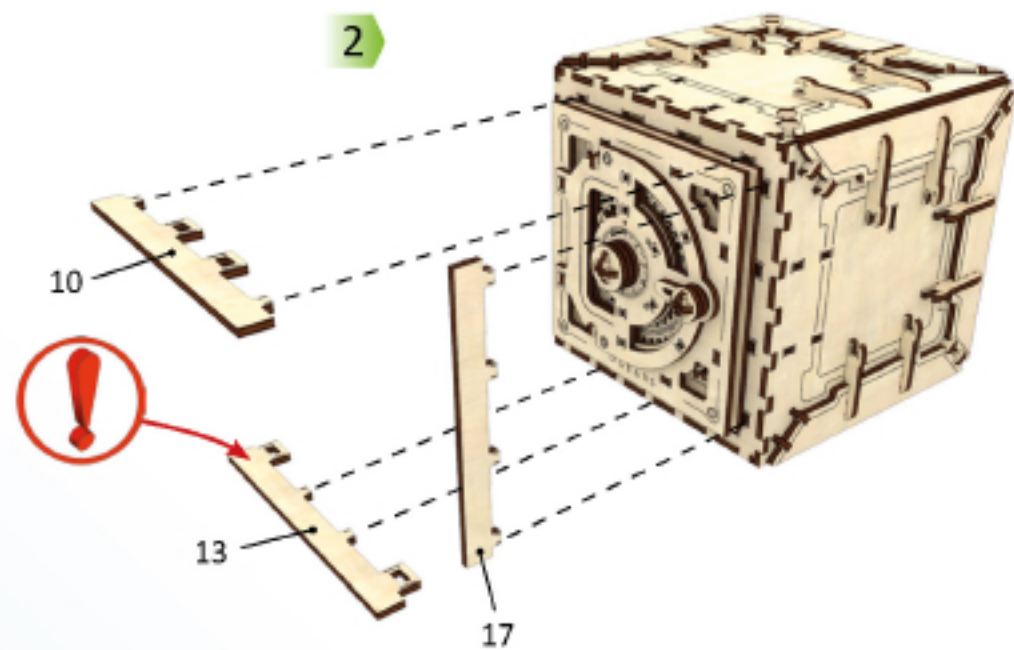
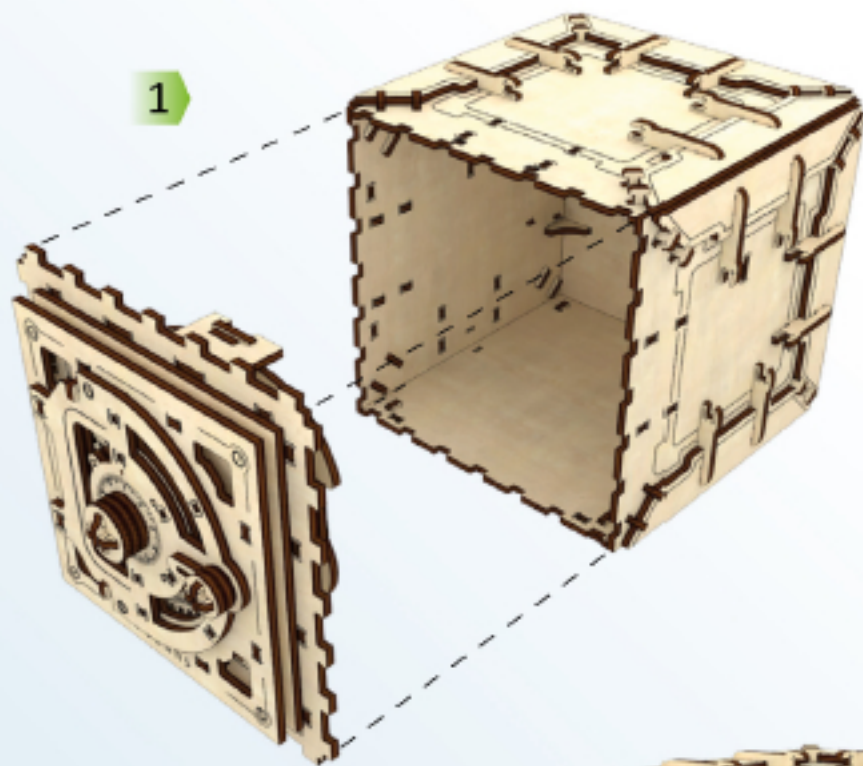
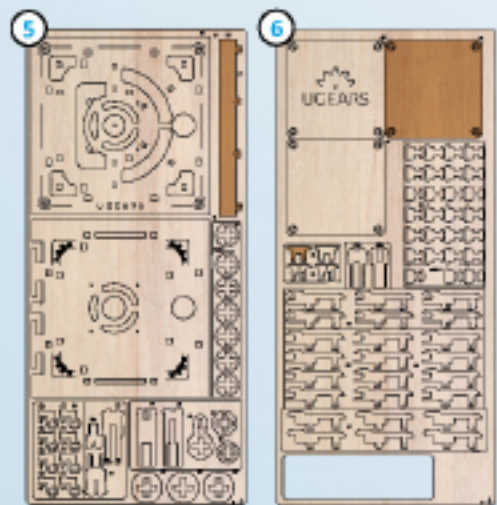
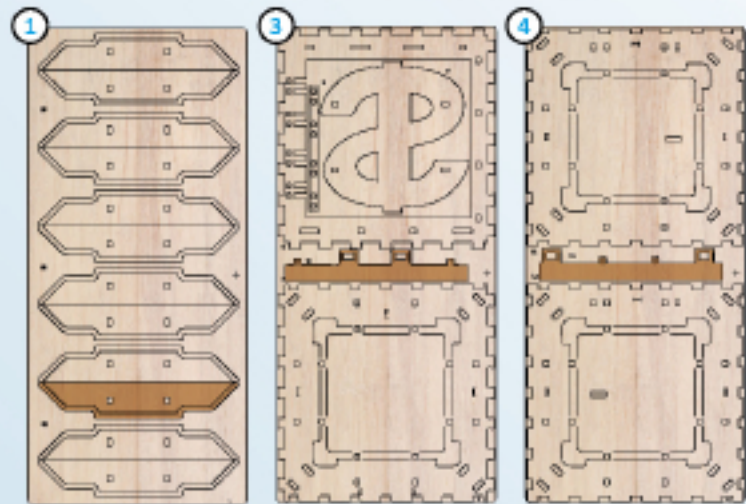

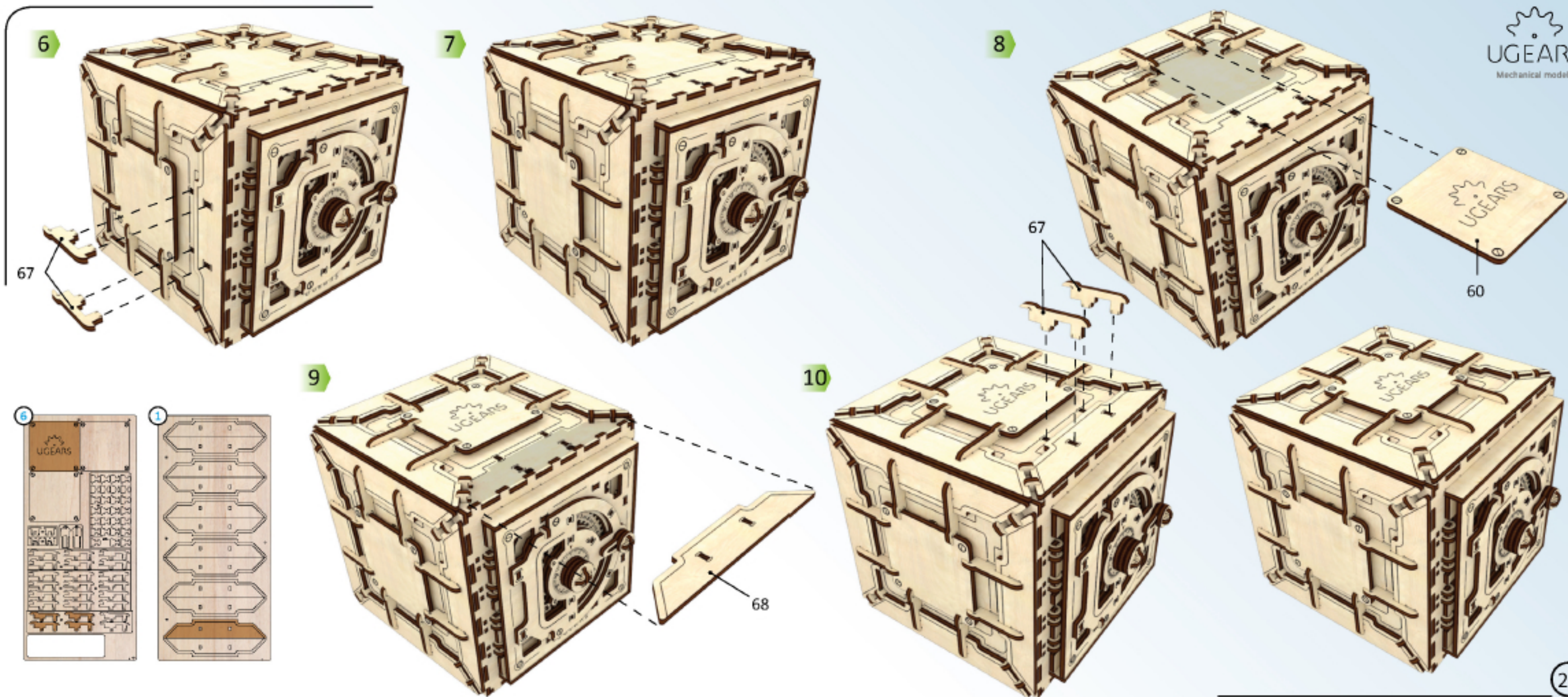

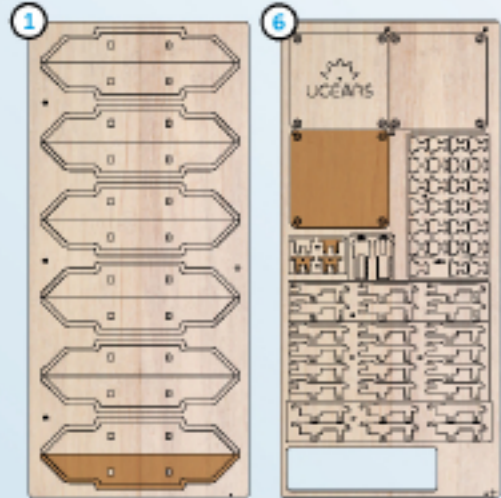

1

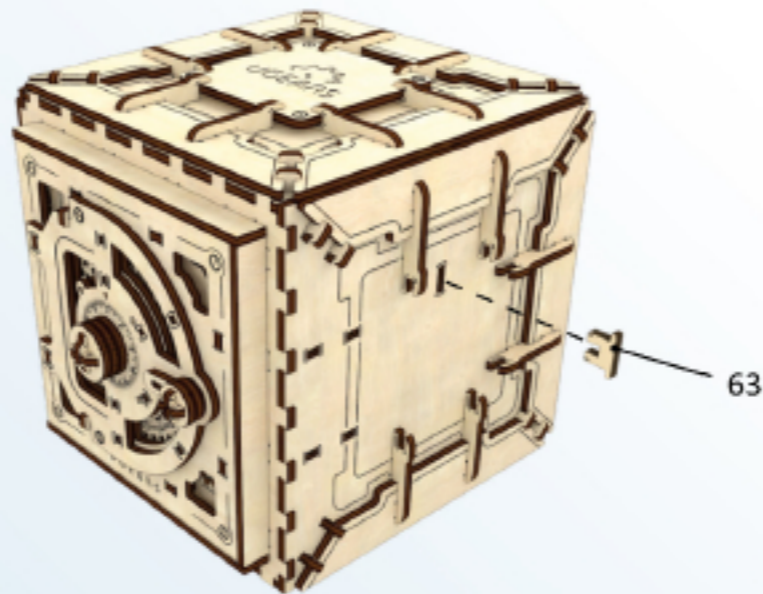

2

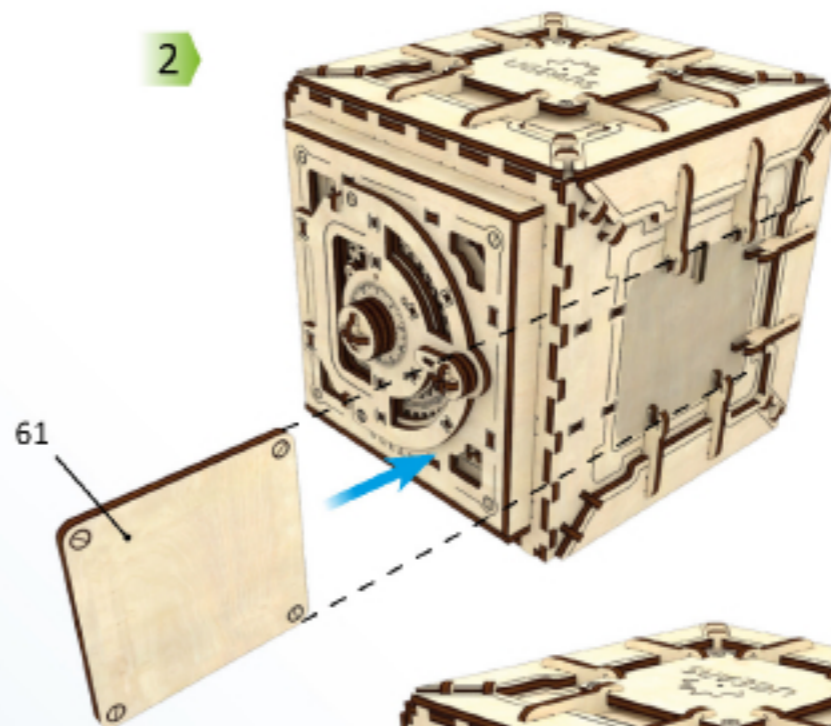

3

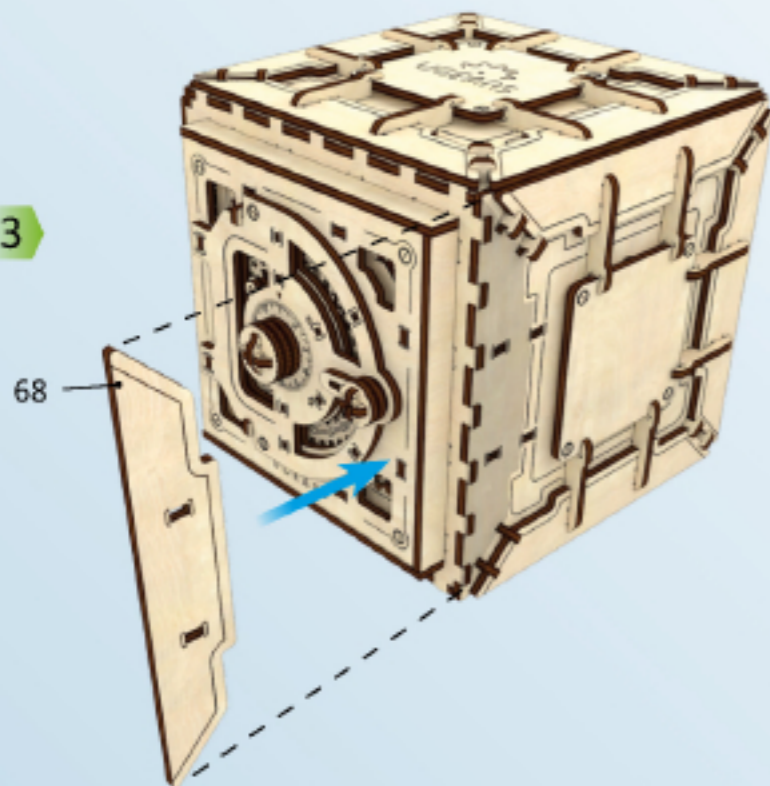

4

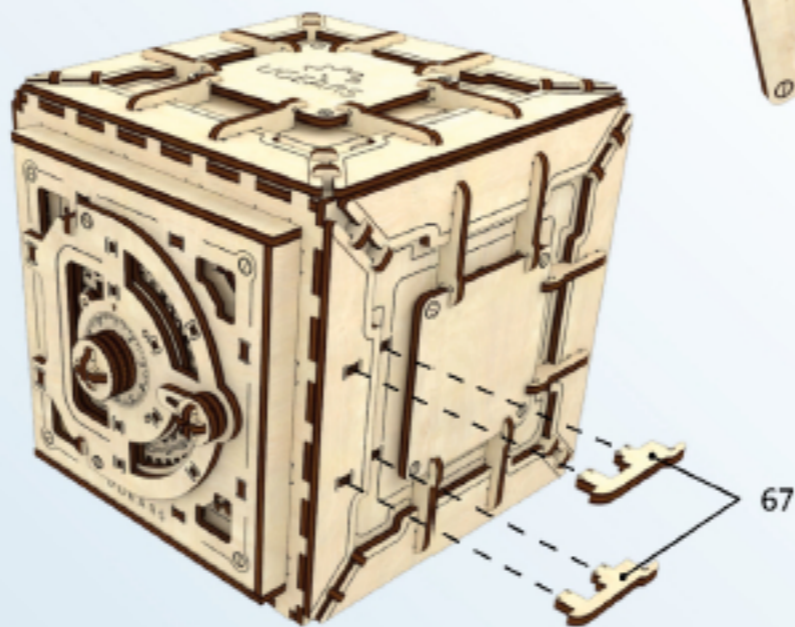

5

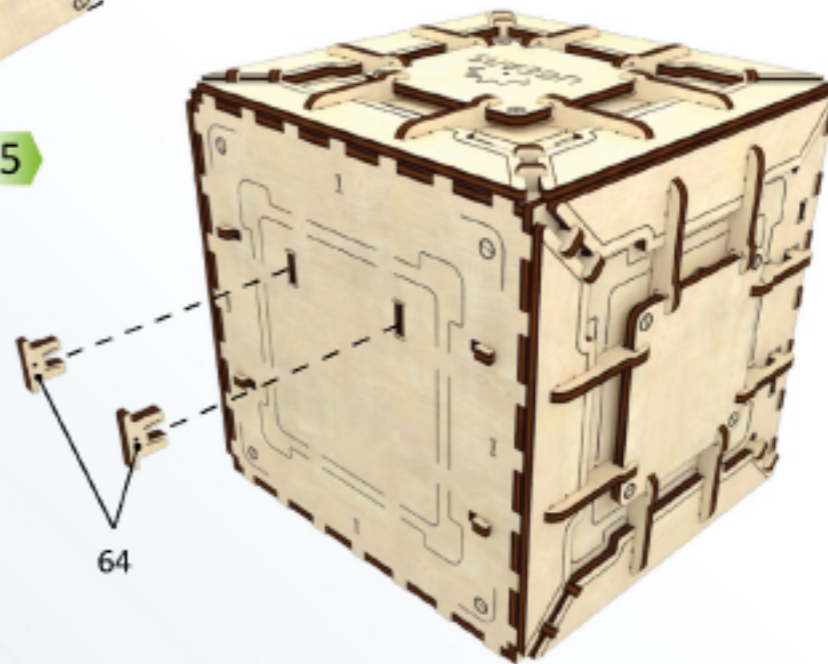

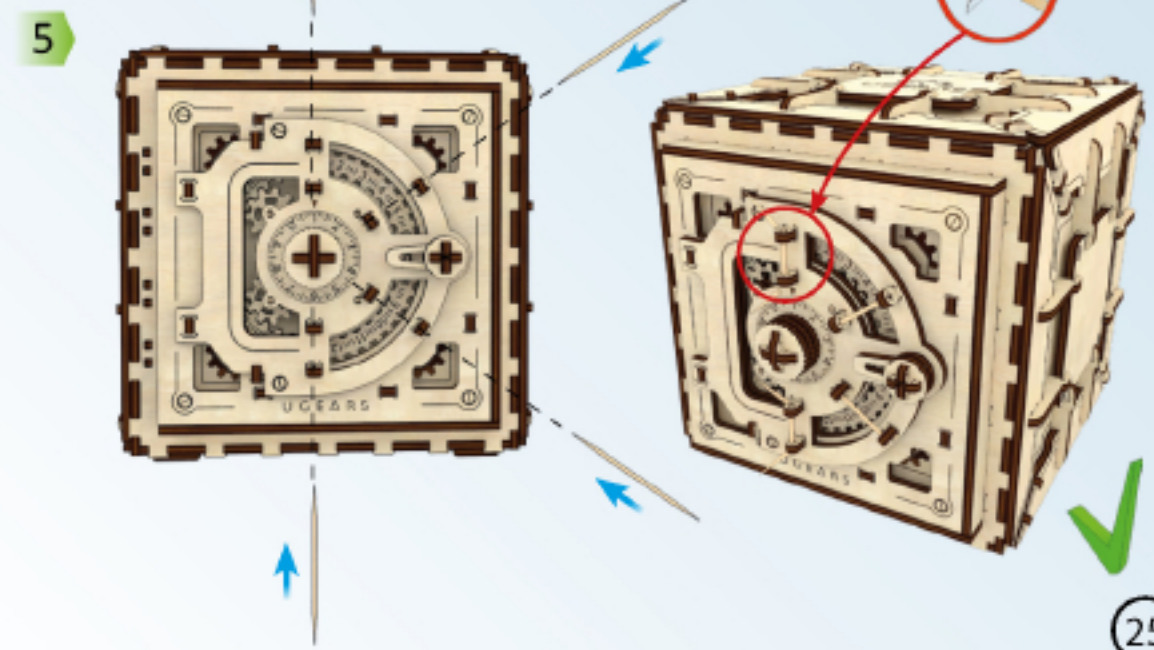
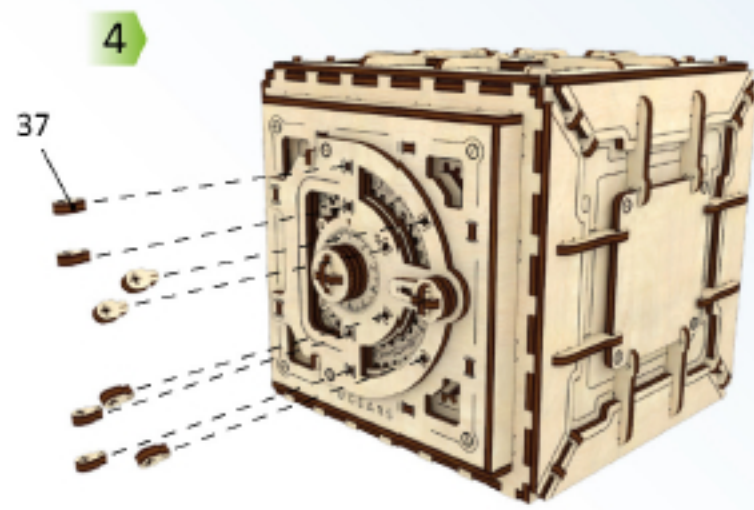
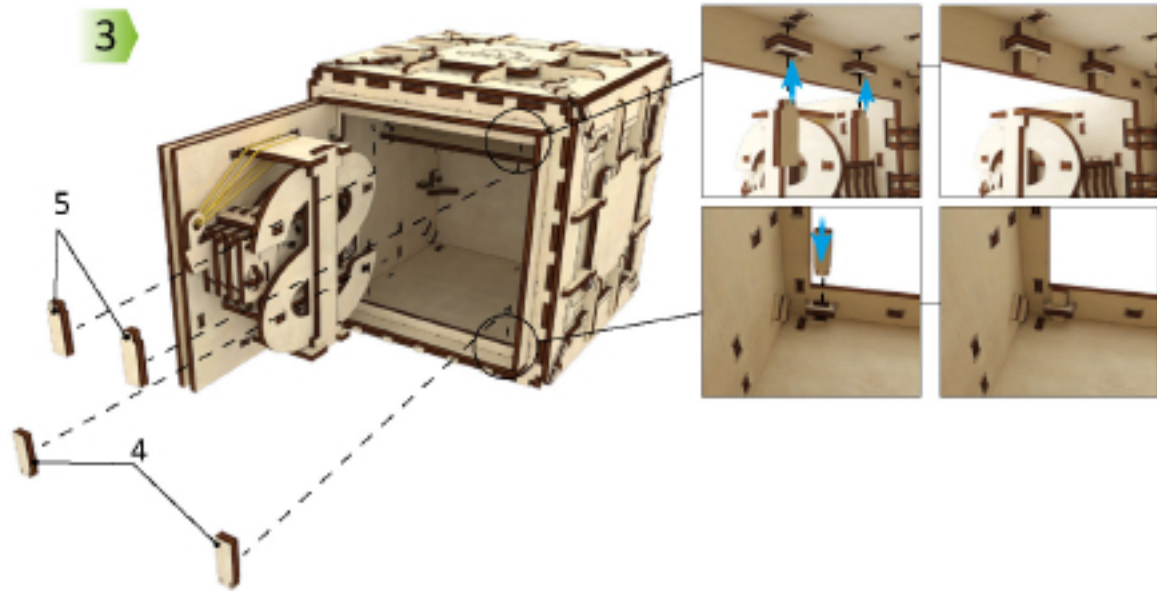
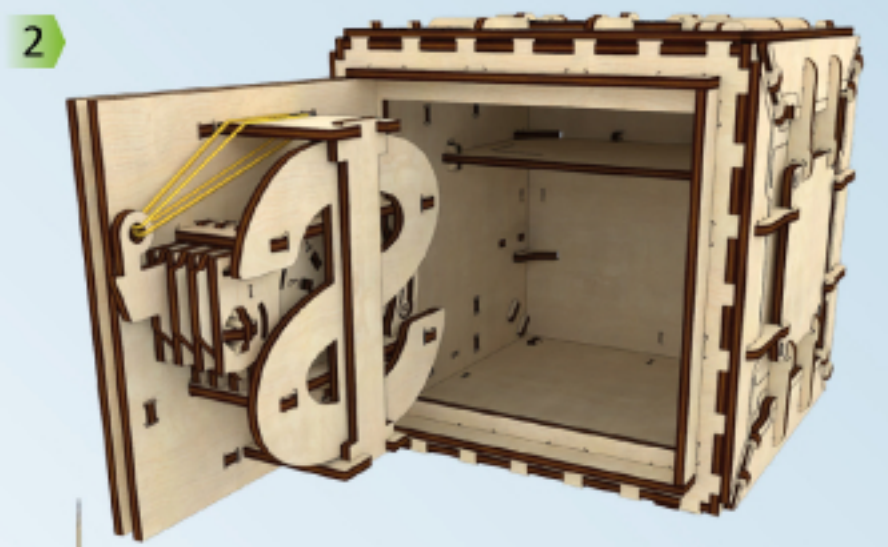
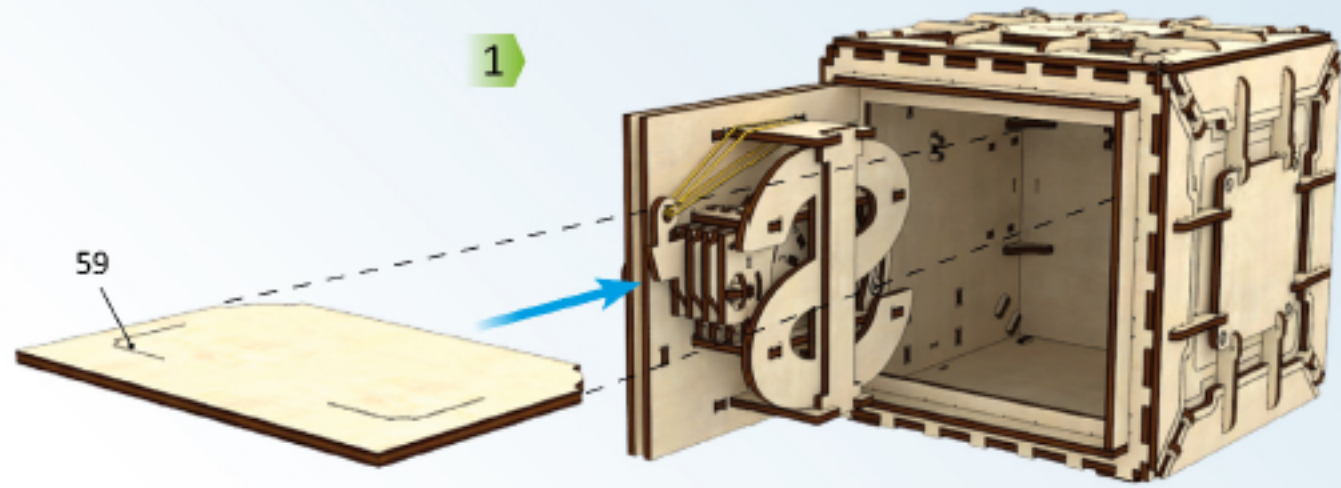
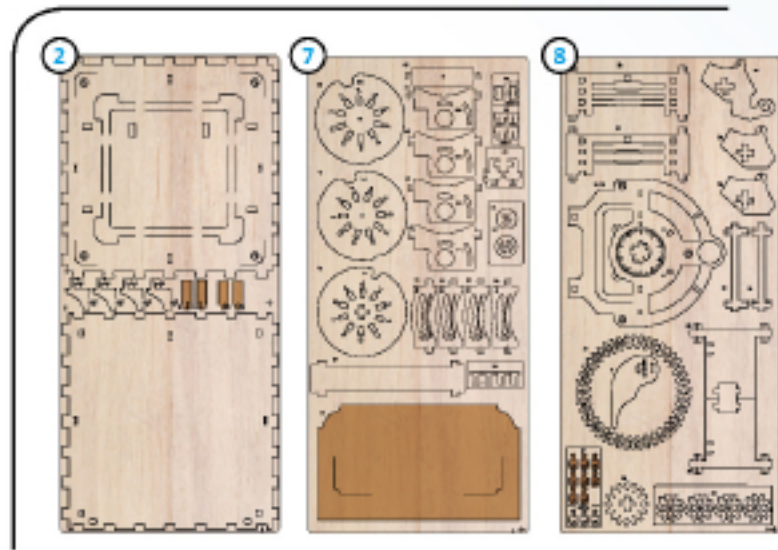



Indrukken

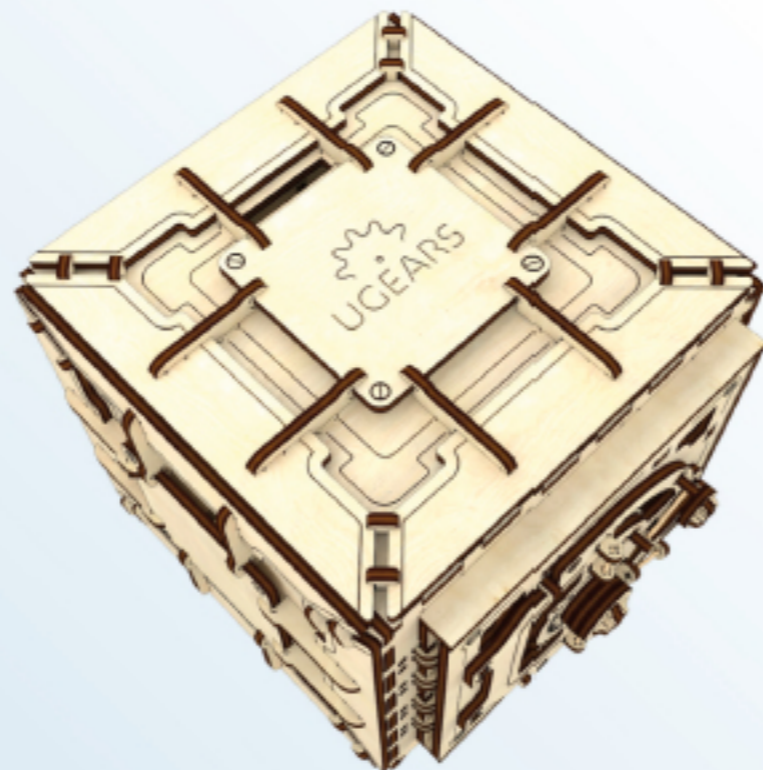
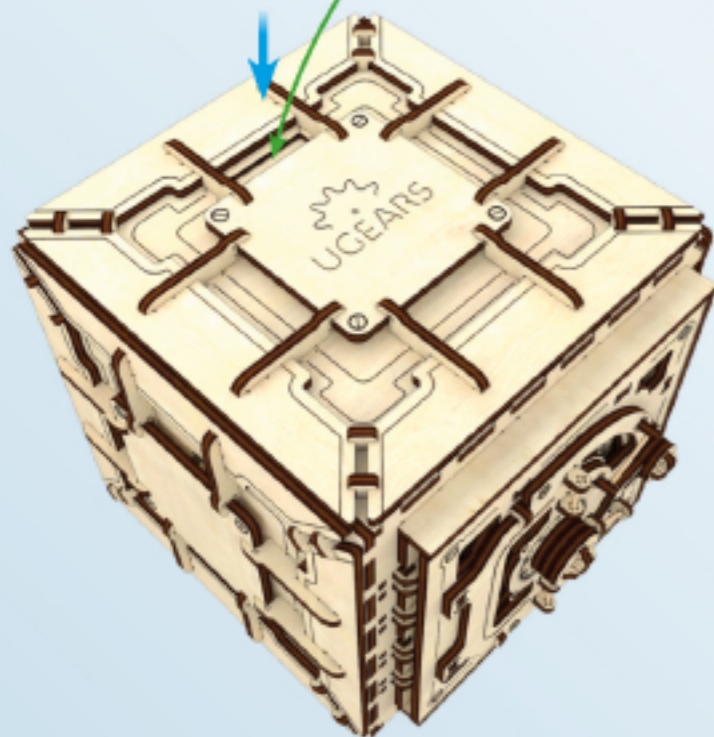



Noodopening

1

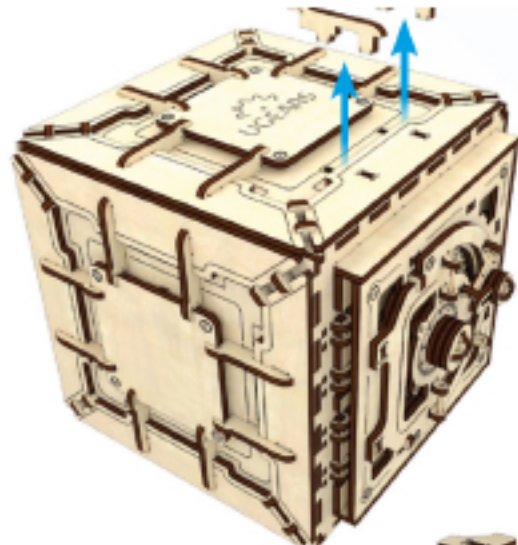

2

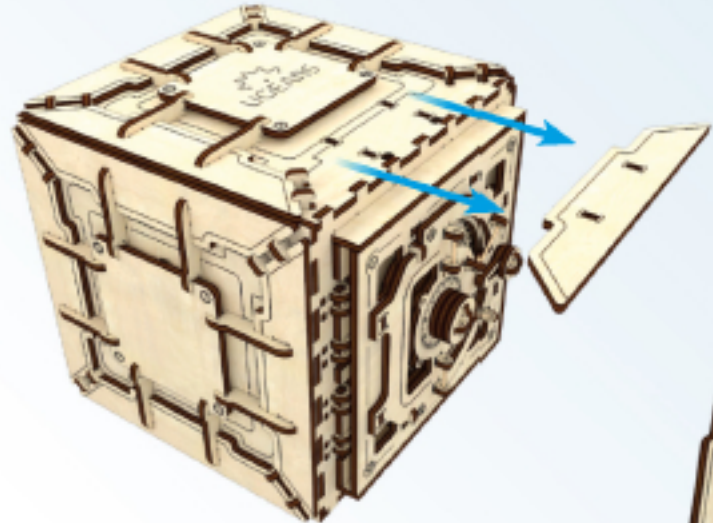

3

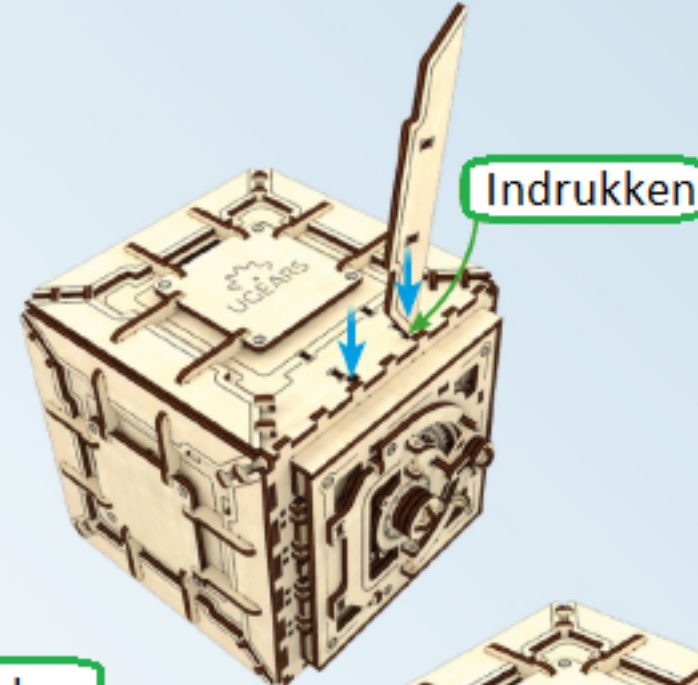

4

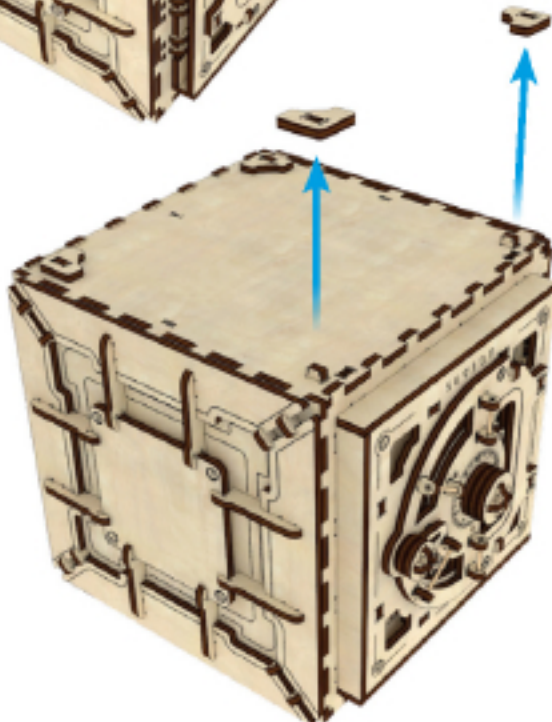

5

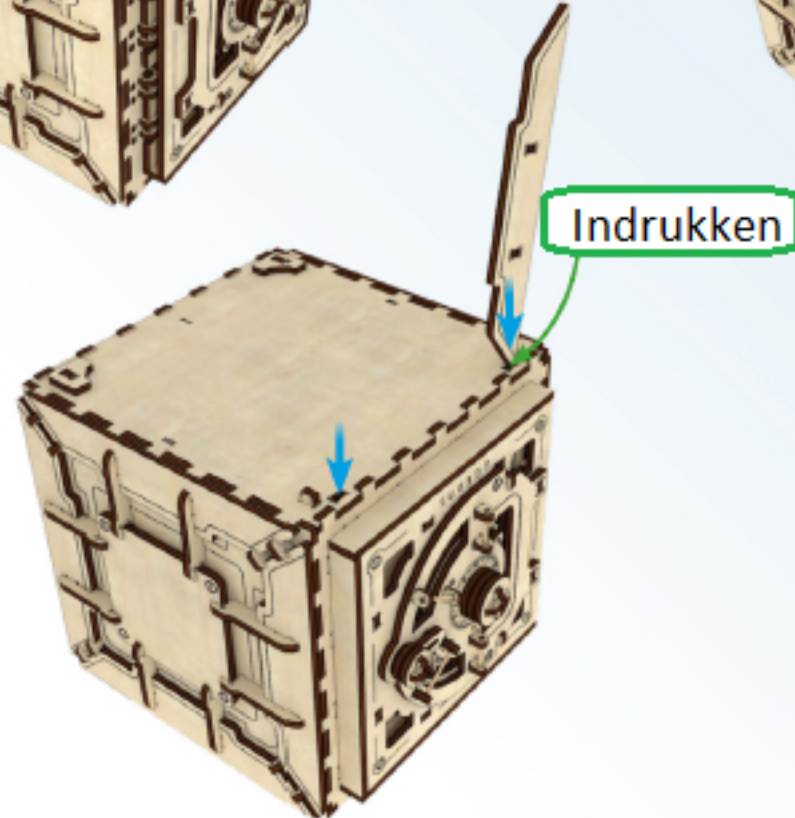

6

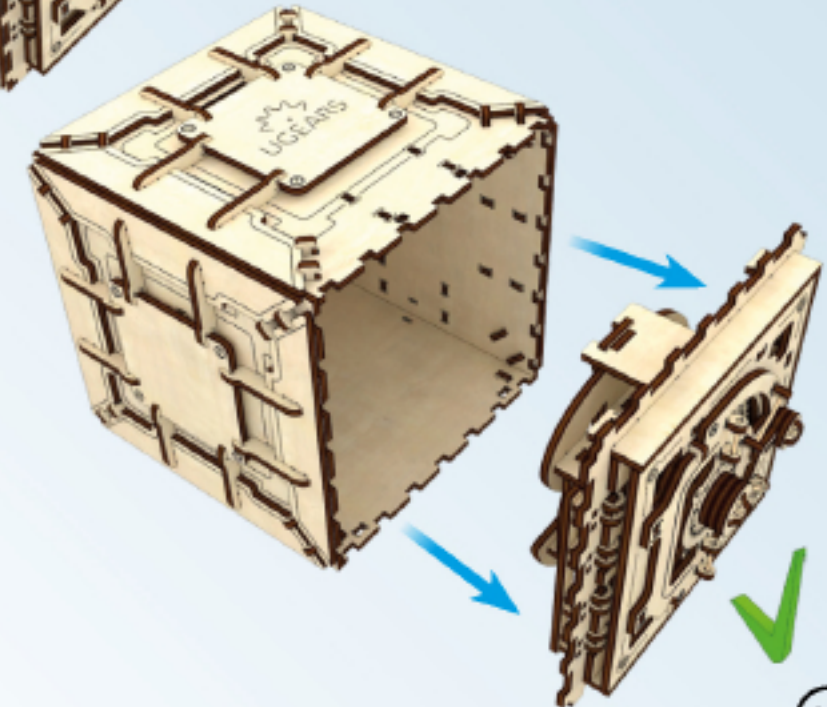

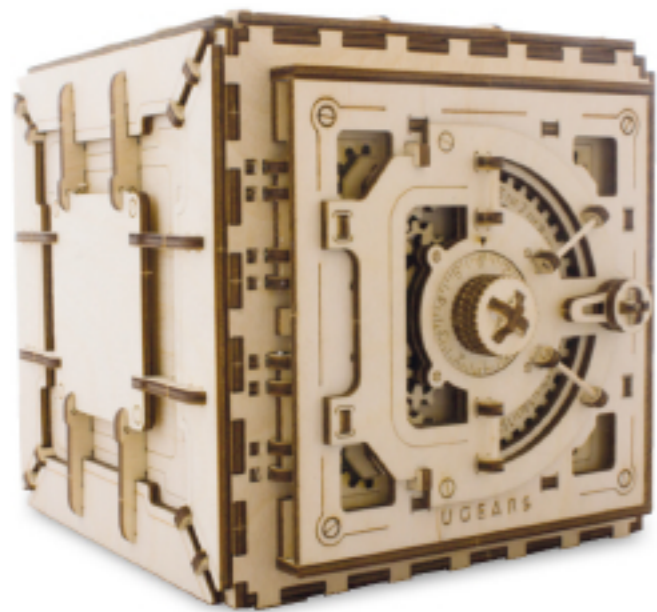

UGEAR'S.
Mechanical models
ugears-shop.nl

Bedankt voor de deelname aan deze reis met ons!