

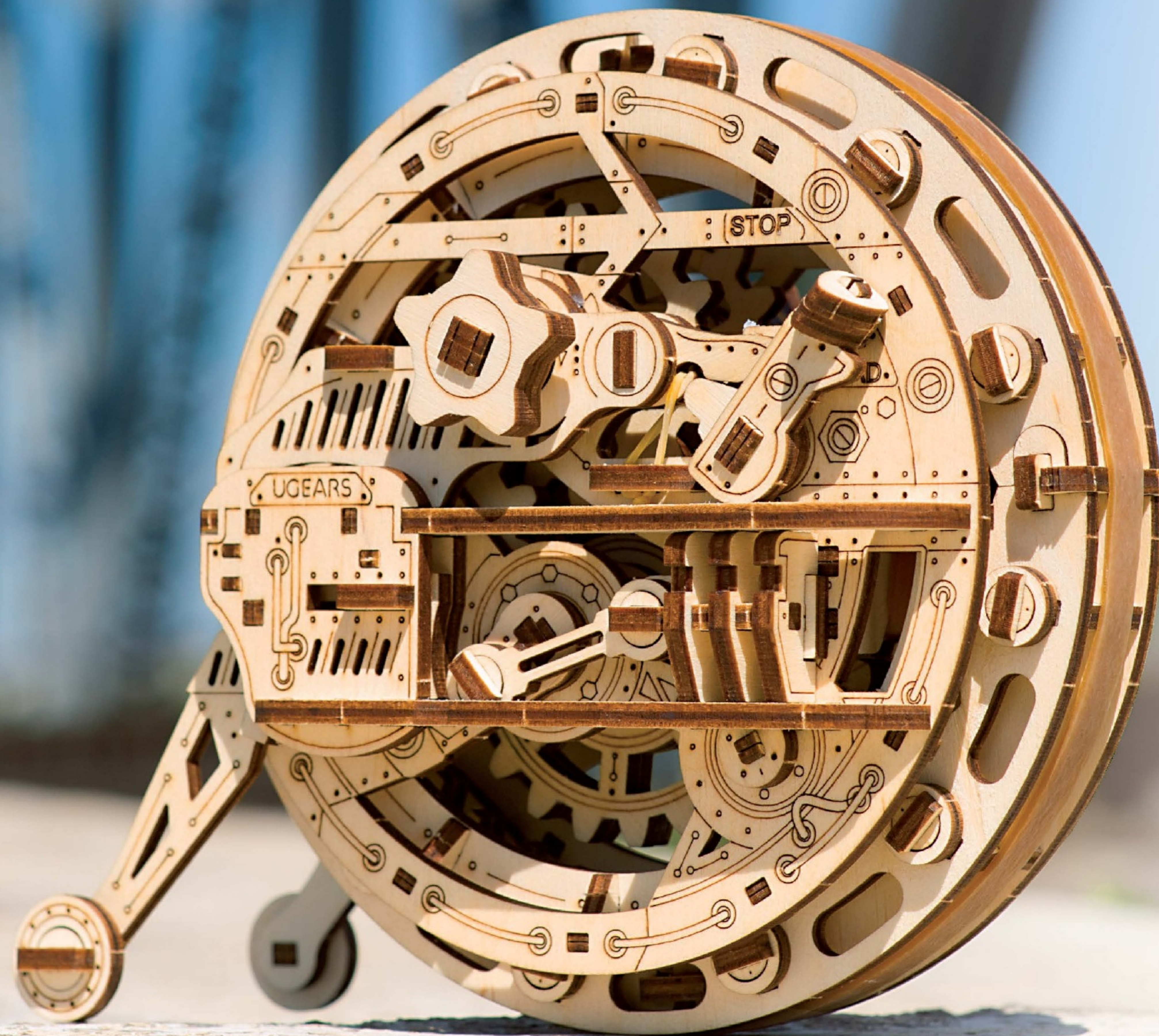

Assemble Me. Propel Me and Let the Fun Roll in!



Find out MORE

UGEARS®
Mechanical models

"Monowheel"

DEU Modell «Einrad». FRA Modèle «Monoroue».
POL Model «Jednokołowiec». SPA Modelo «Mono rueda».
ITA Modello «Monoruota». RUS Модель «Моноколесо».
JAP モノホイール. KOR 모노휠. CHI 独轮自行车

Handleiding in het Nederlands

DEU Aufbauanleitung. FRA Notice d'assemblage. POL Instrukcja montażu.
SPA Instrucciones de montaje. ITA Istruzioni di montaggio.
RUS Инструкция по сборке. JAP 組み立て説明書
KOR 조립 설명서. CHI 装配说明书



NATURAL
Made from wood materials



NO GLUE CONNECTION
Assembling without glue
and chemicals



SELF ASSEMBLY
Details are already cut
and ready to assemble



MECHANICAL
The models produce motion



EDUCATIONAL
Perfect for family projects
through hands-on STEM learning

Bouwinstructies.

Verwijder de onderdelen van de borden zoals hieronder is geïllustreerd. Pas op dat de onderdelen niet breken. Wanneer het niet loskomt, gebruik dan voorzichtig een mesje. Dit model bouwt u zelf zonder gebruik te maken van lijm. Wanneer onderdelen moeilijk te plaatsen zijn. Smeer deze dan in met een kaars. Om frictie te voorkomen behandelt u ook alle beweegbare onderdelen met een kaars.



Reserveonderdelen.

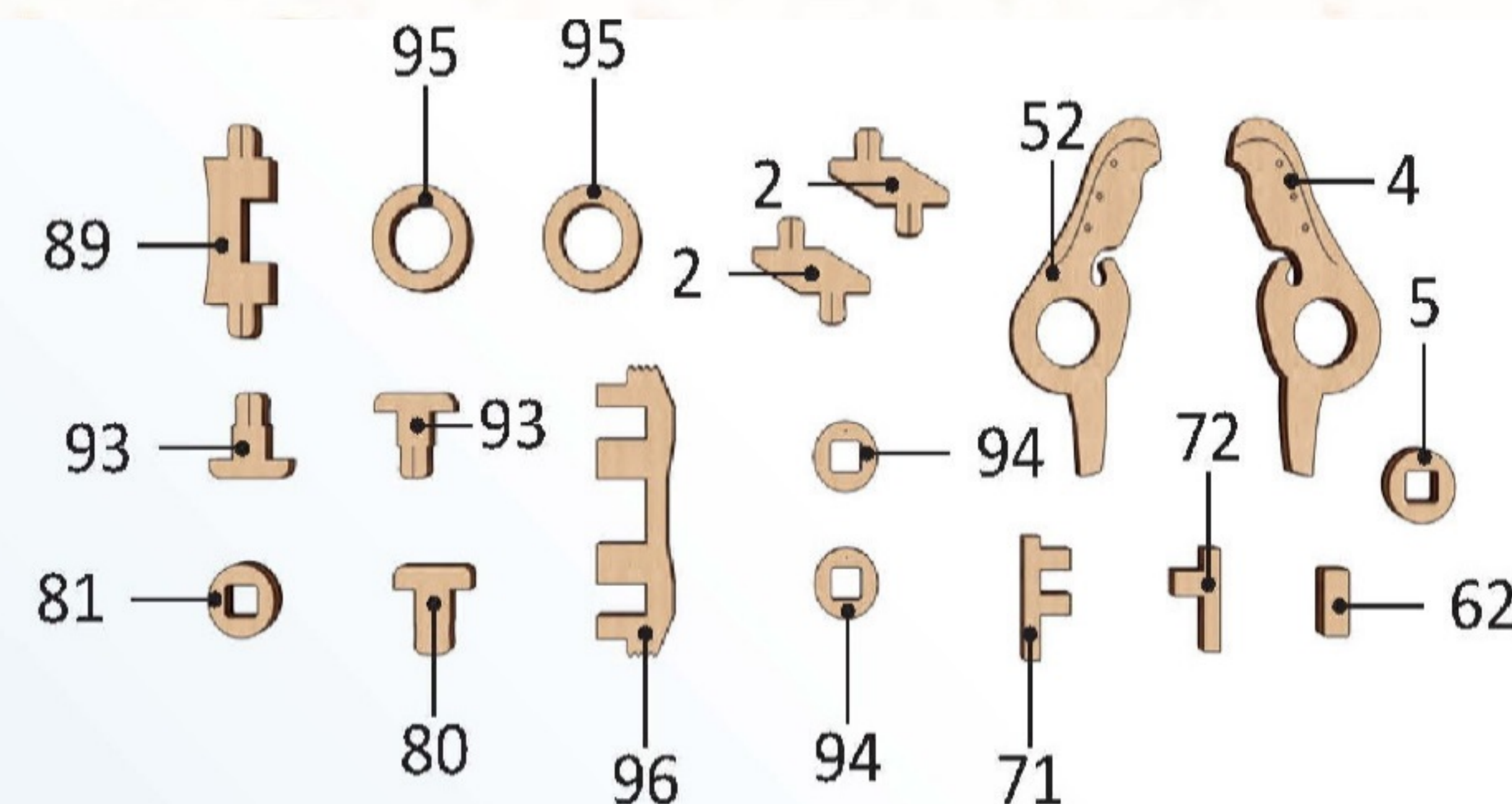
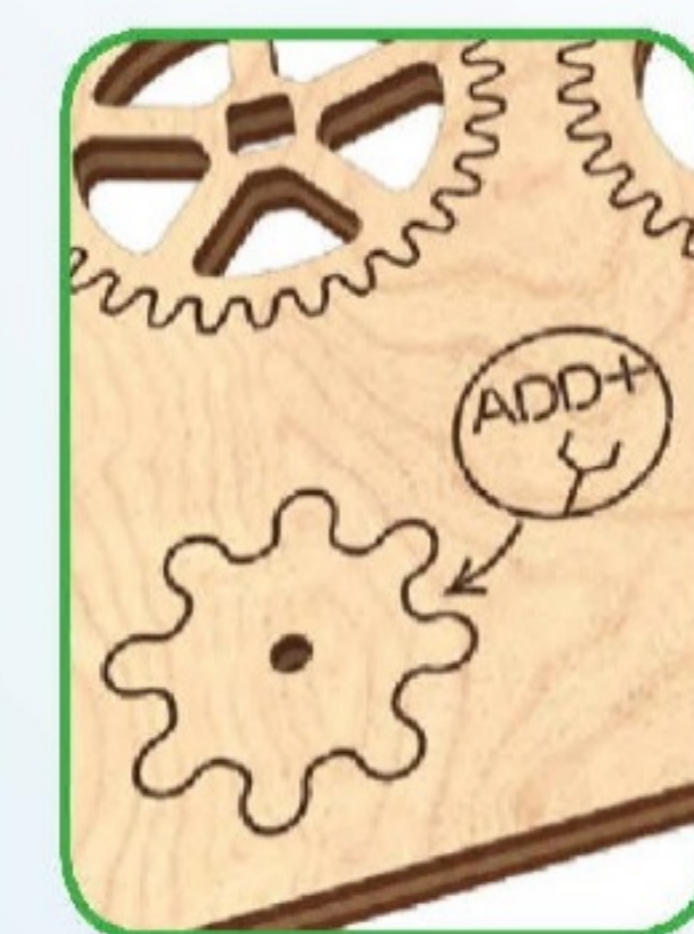

Waarschuwing!









Gebruik geen kaars die brand!



Opgepast, de spieën zijn scherp!

Pictogrammen.

-  Smeer het onderdeel in met kaarsvet.
-  Opgelet! Controleer de goede positie.
-  Schuur om de bramen te verwijderen.
-  Het onderdeel moet gemakkelijk te draaien zijn.
-  Herhaal de stap maar dan gespiegeld.
-  Controleer het mechanisme op een soepele en goede beweging. Breng het mechanisme in beweging om de onderdelen in positie te krijgen.

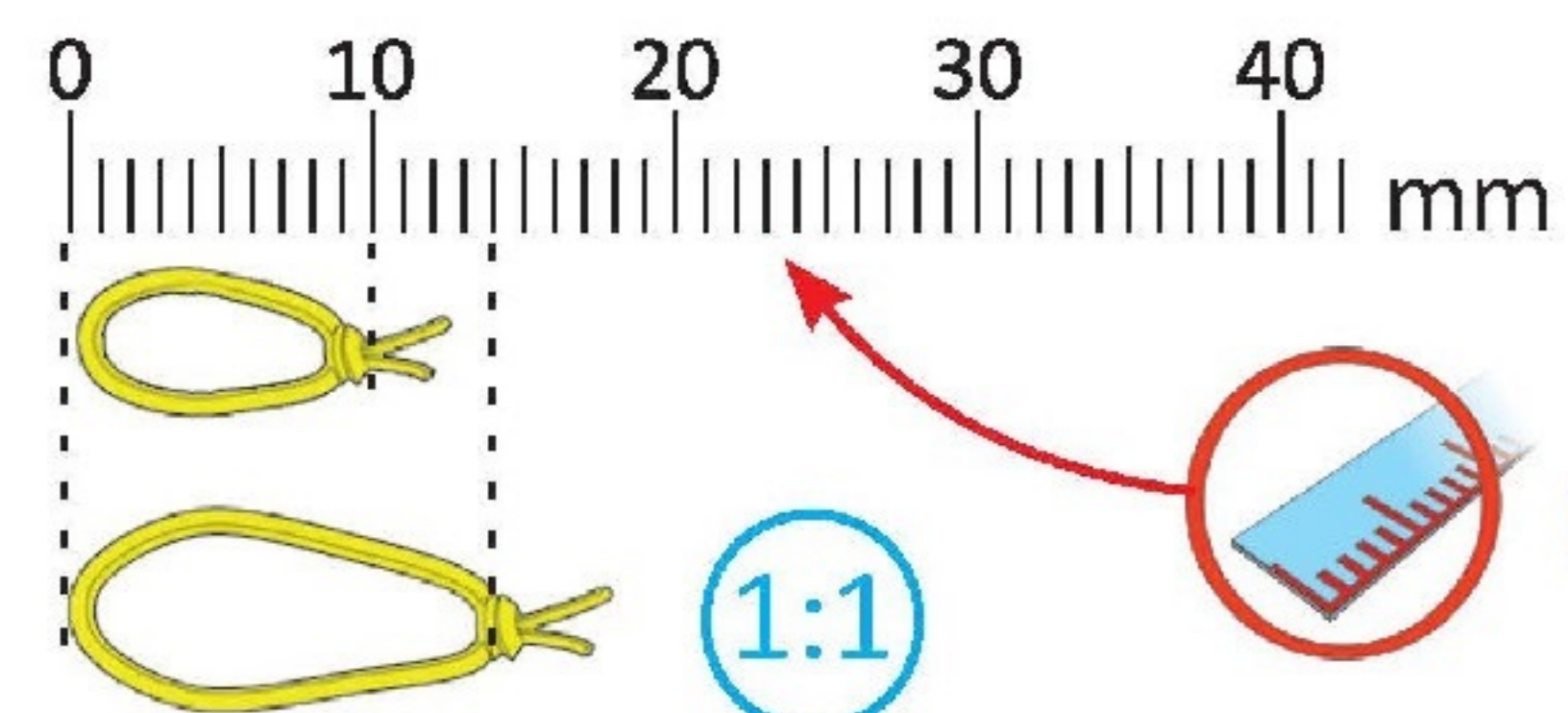

 Controleer grootte.



Dit is geen onderdeel. Het is een gereedschap voor meting en montage. Leder model heeft z'n eigen gereedschap.

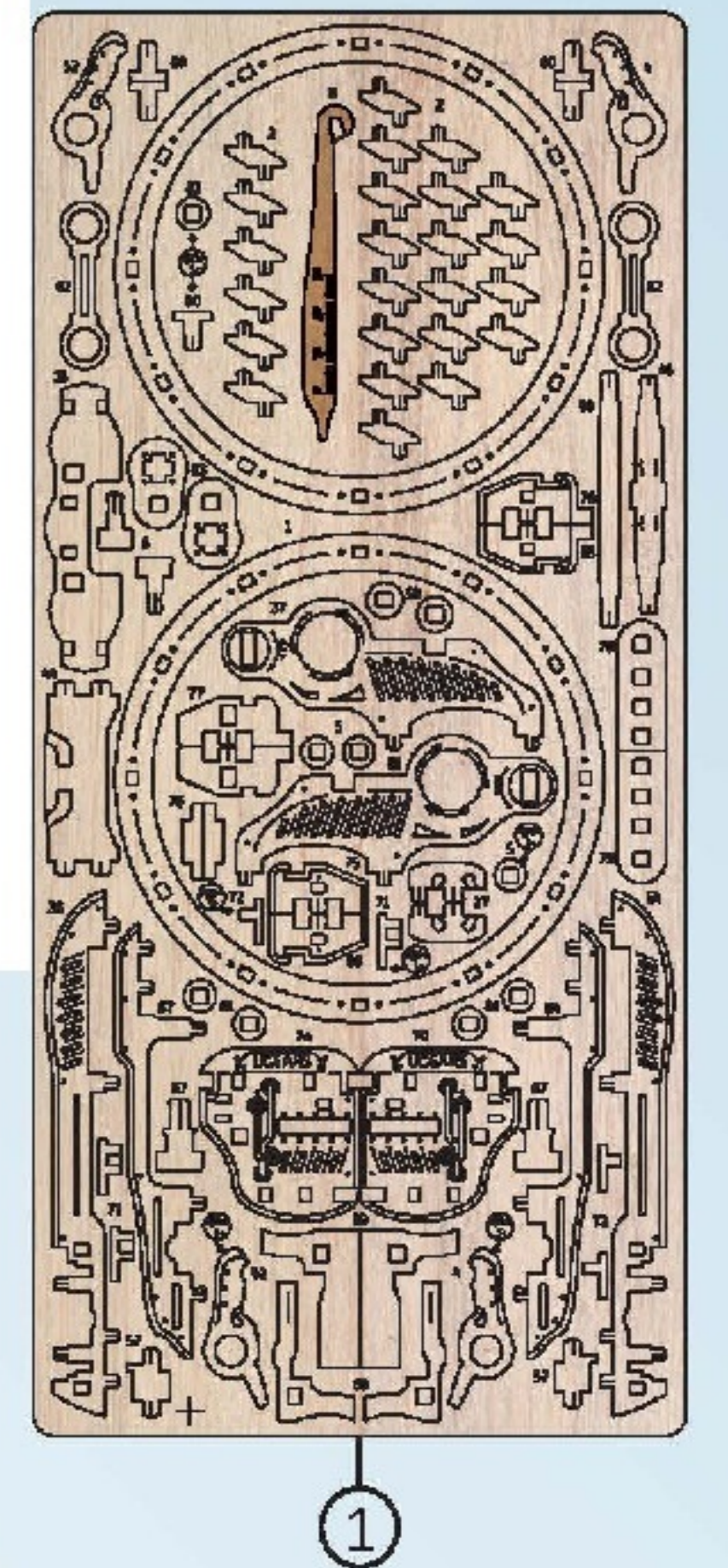
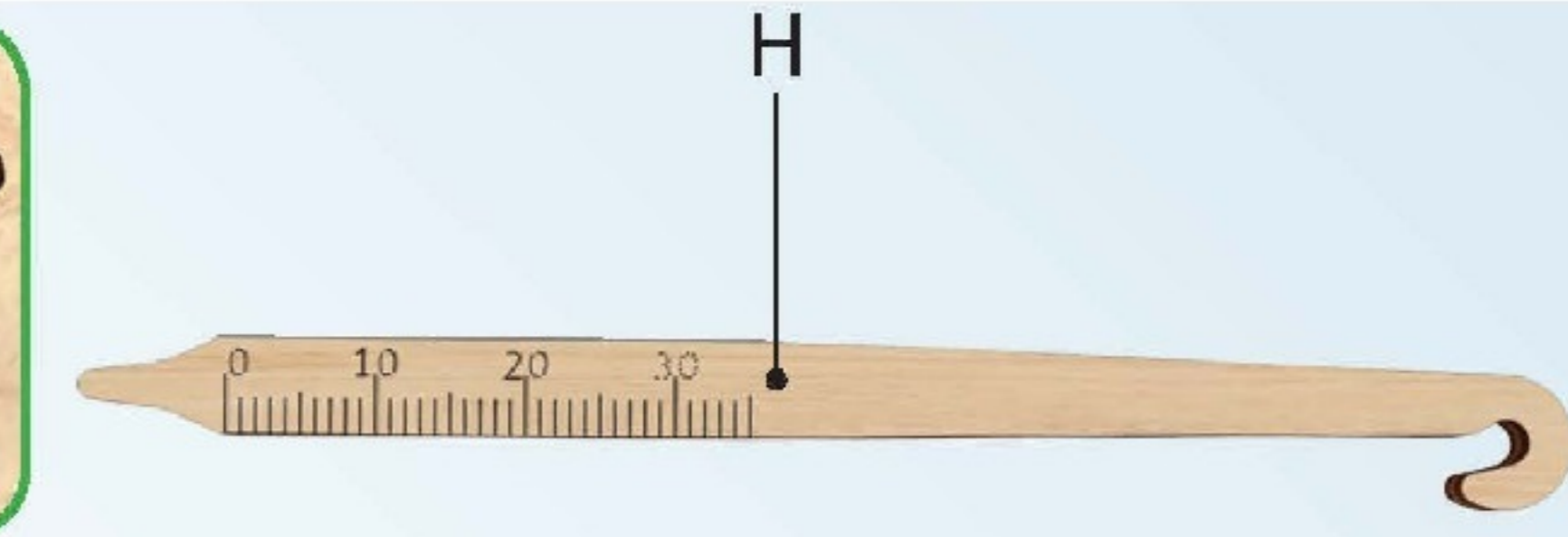
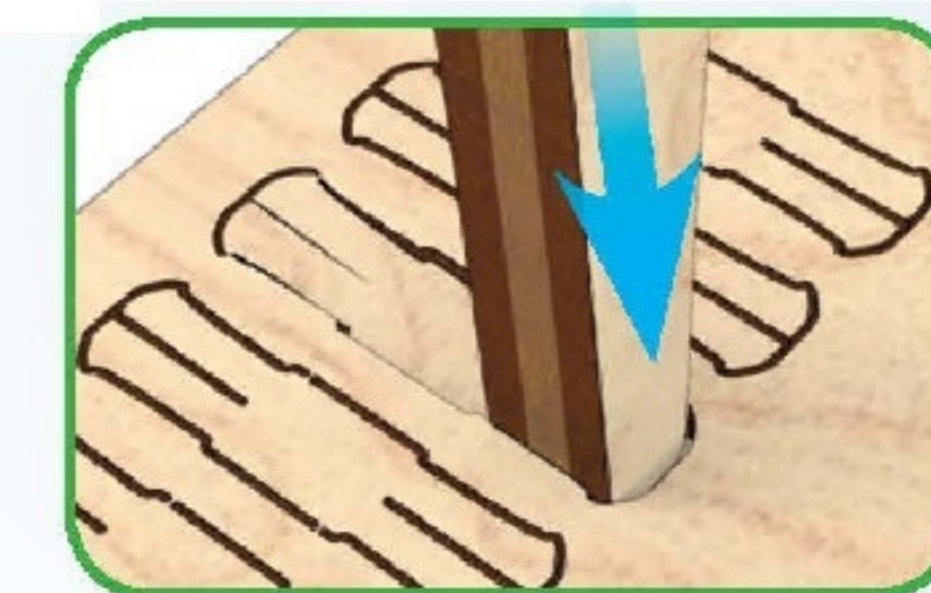

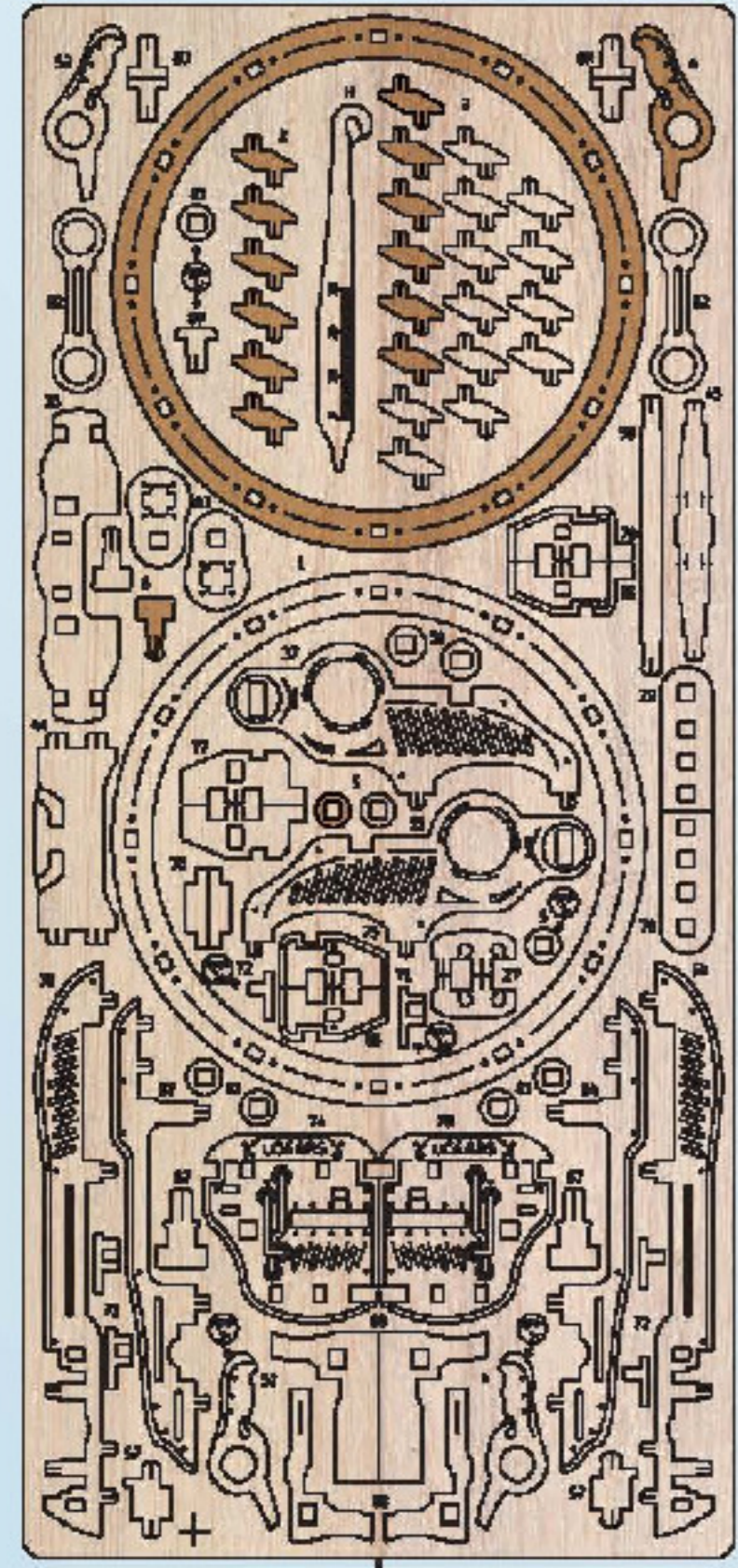

1

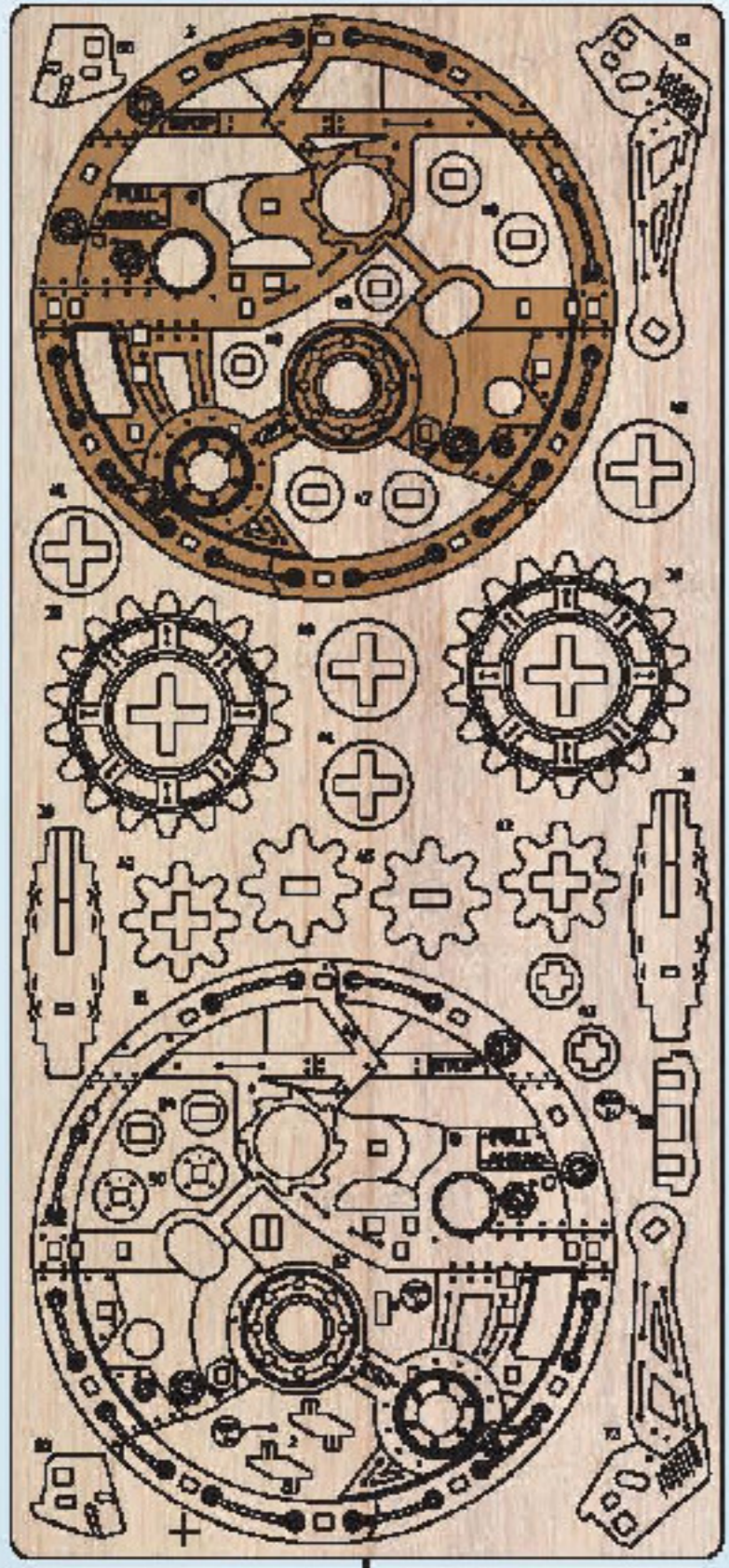

3

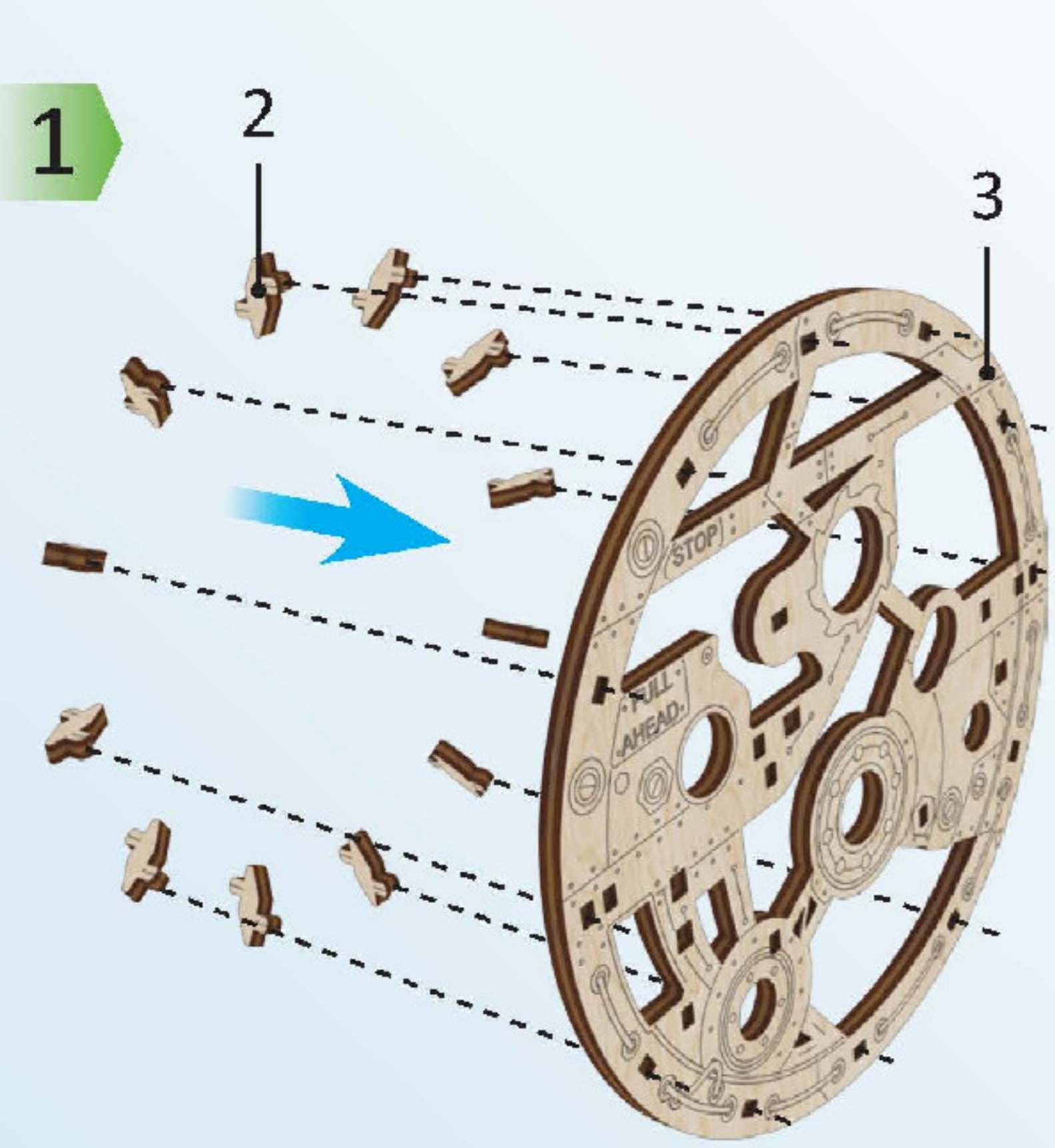

1

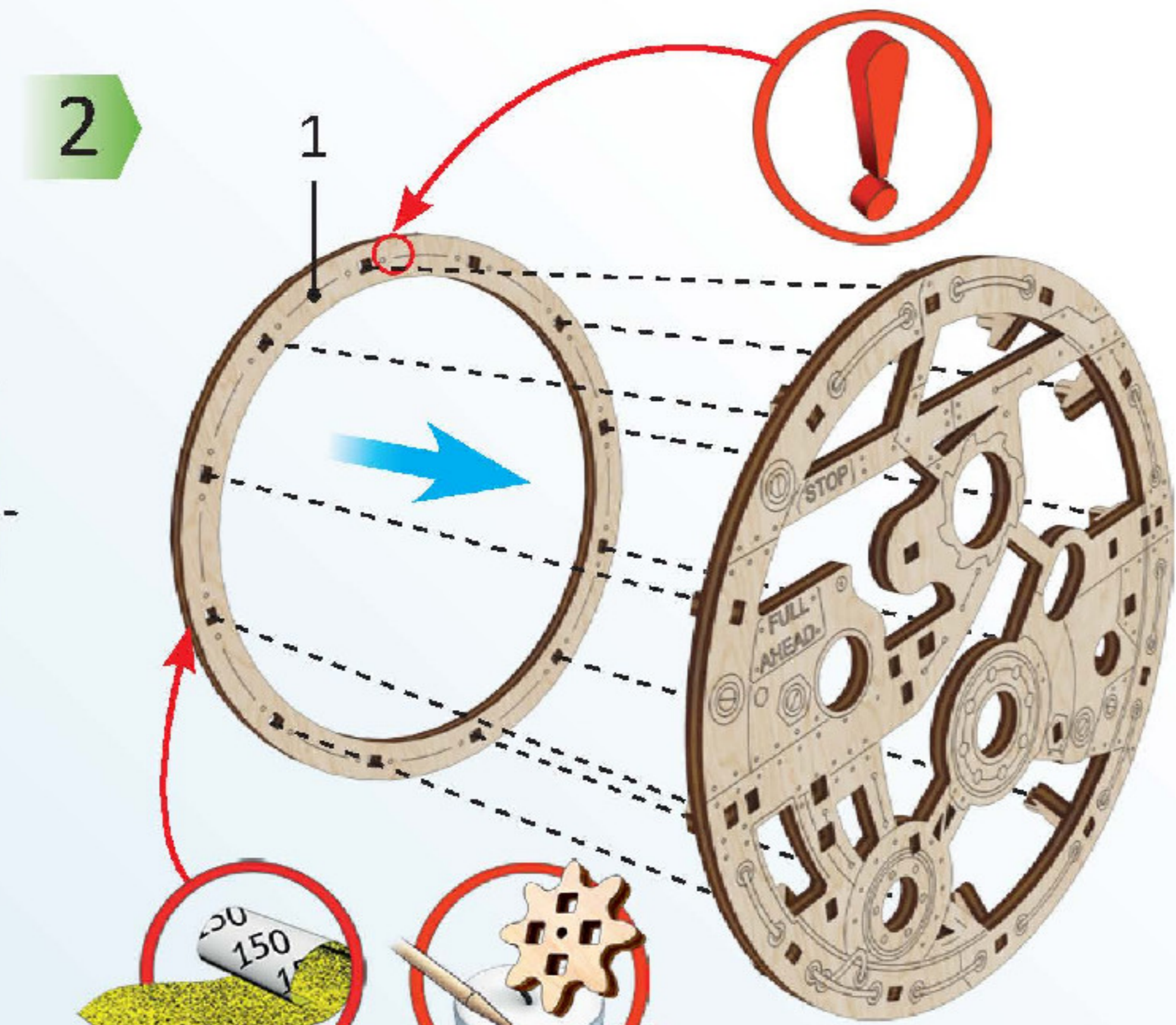

2

1

2

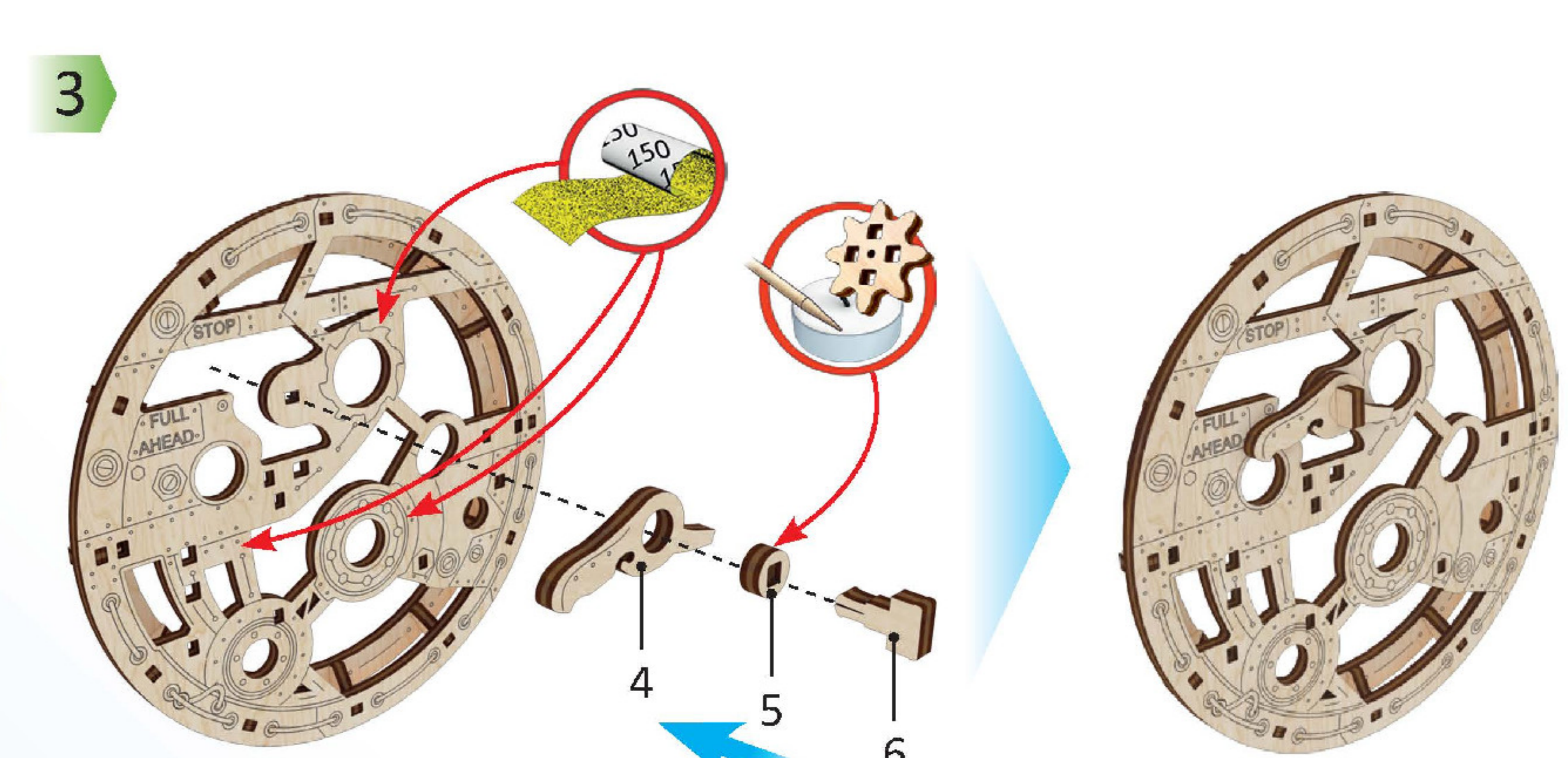

3

4

5

6

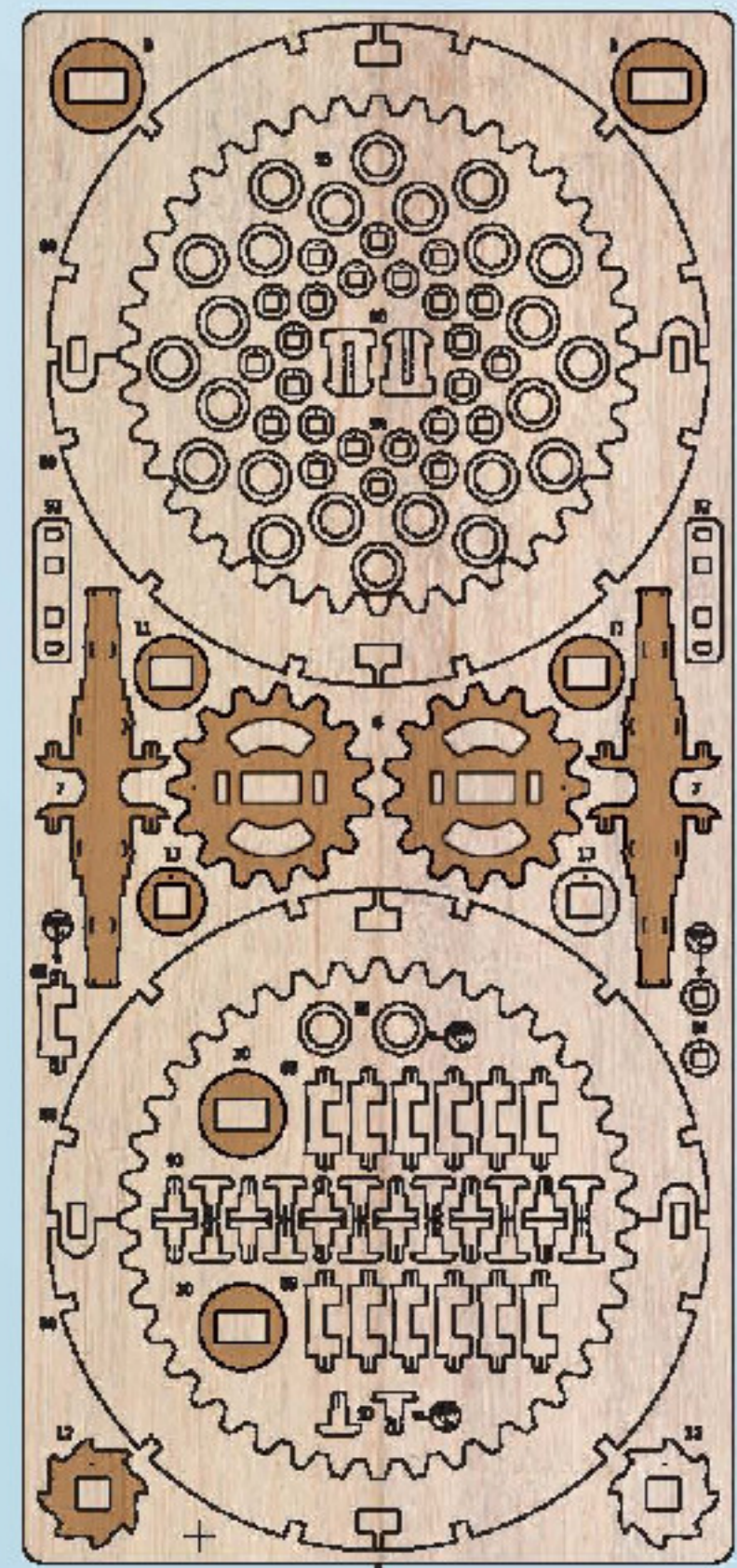

4

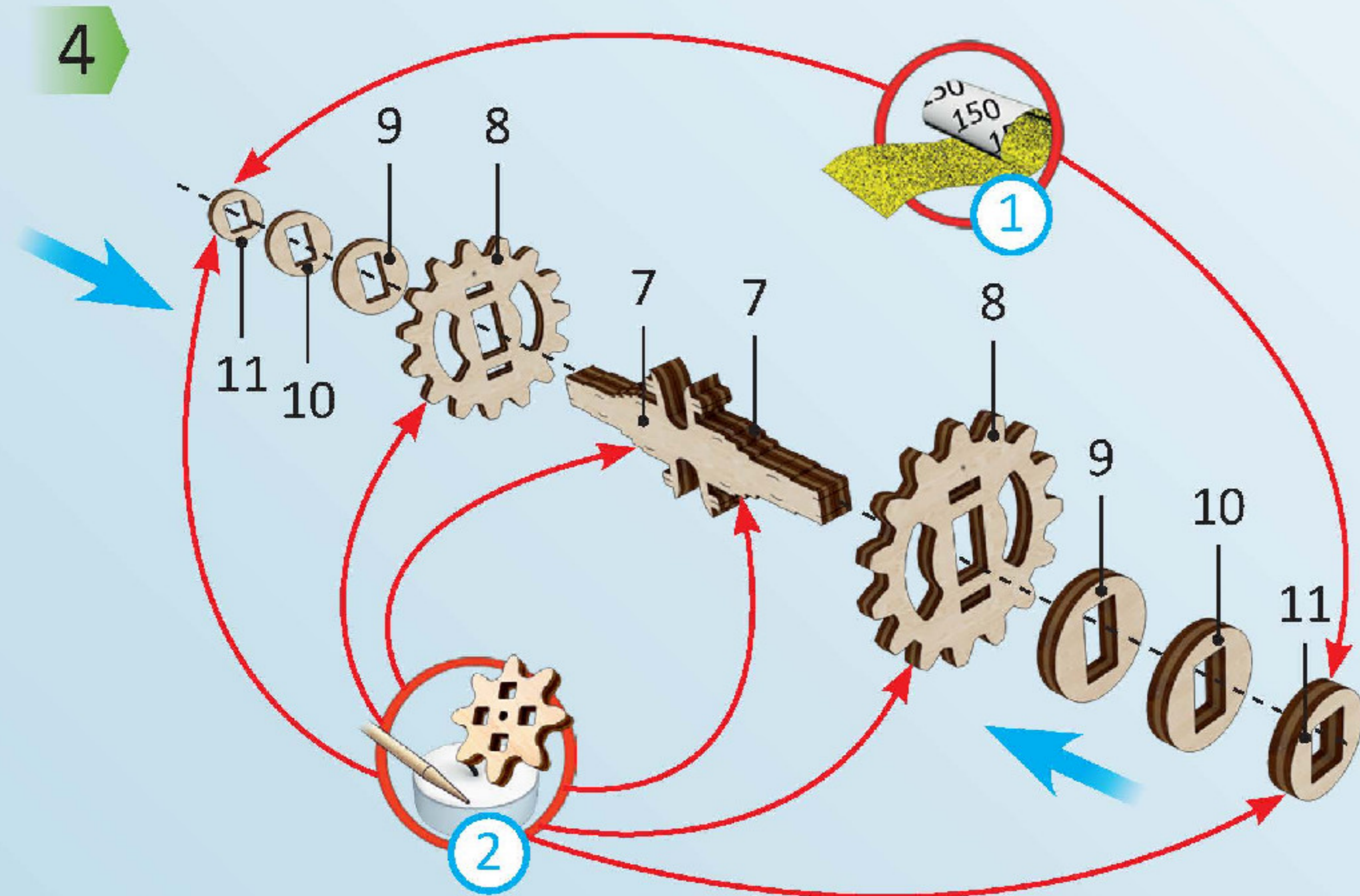

4

2

1



5

1

12

13

4

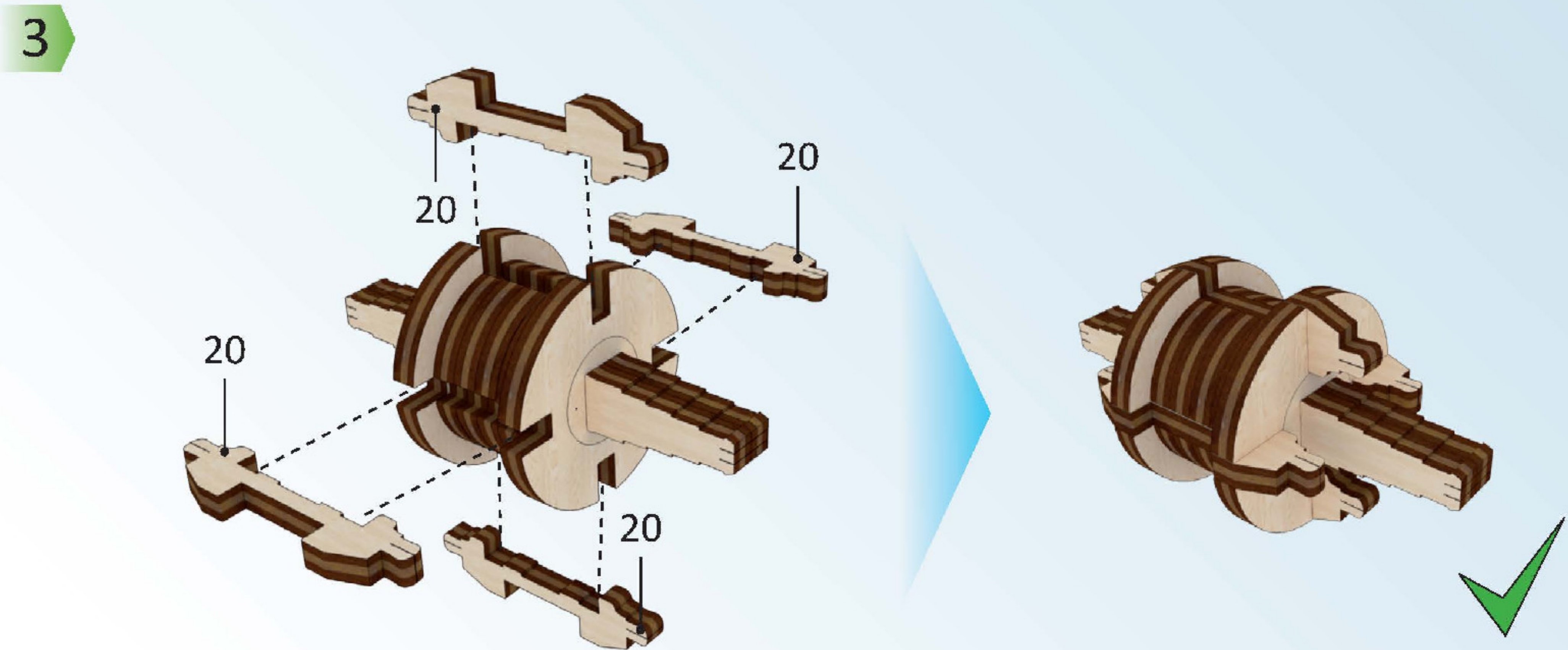
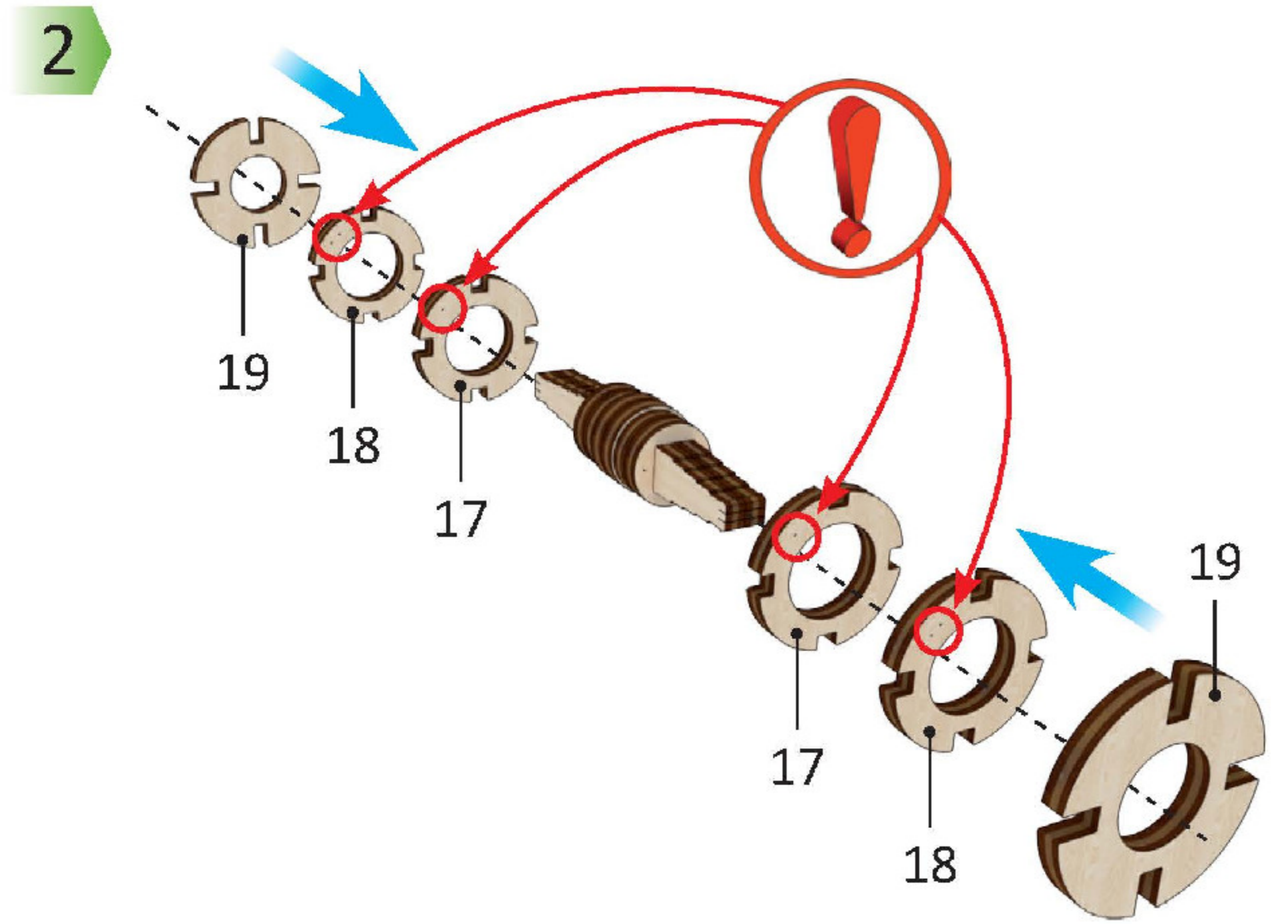
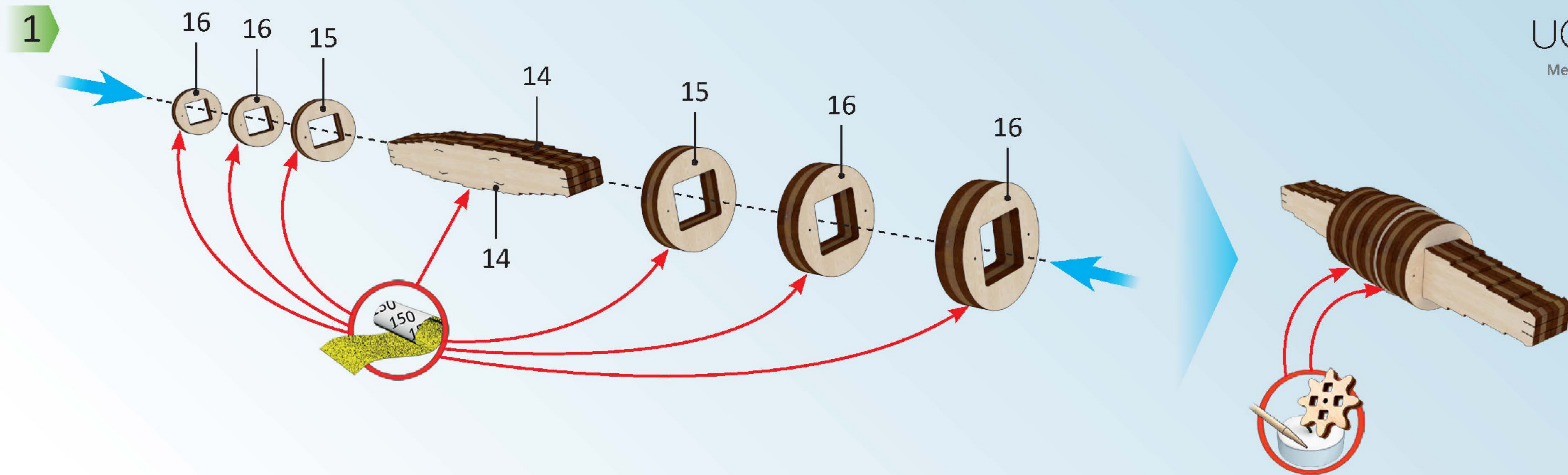
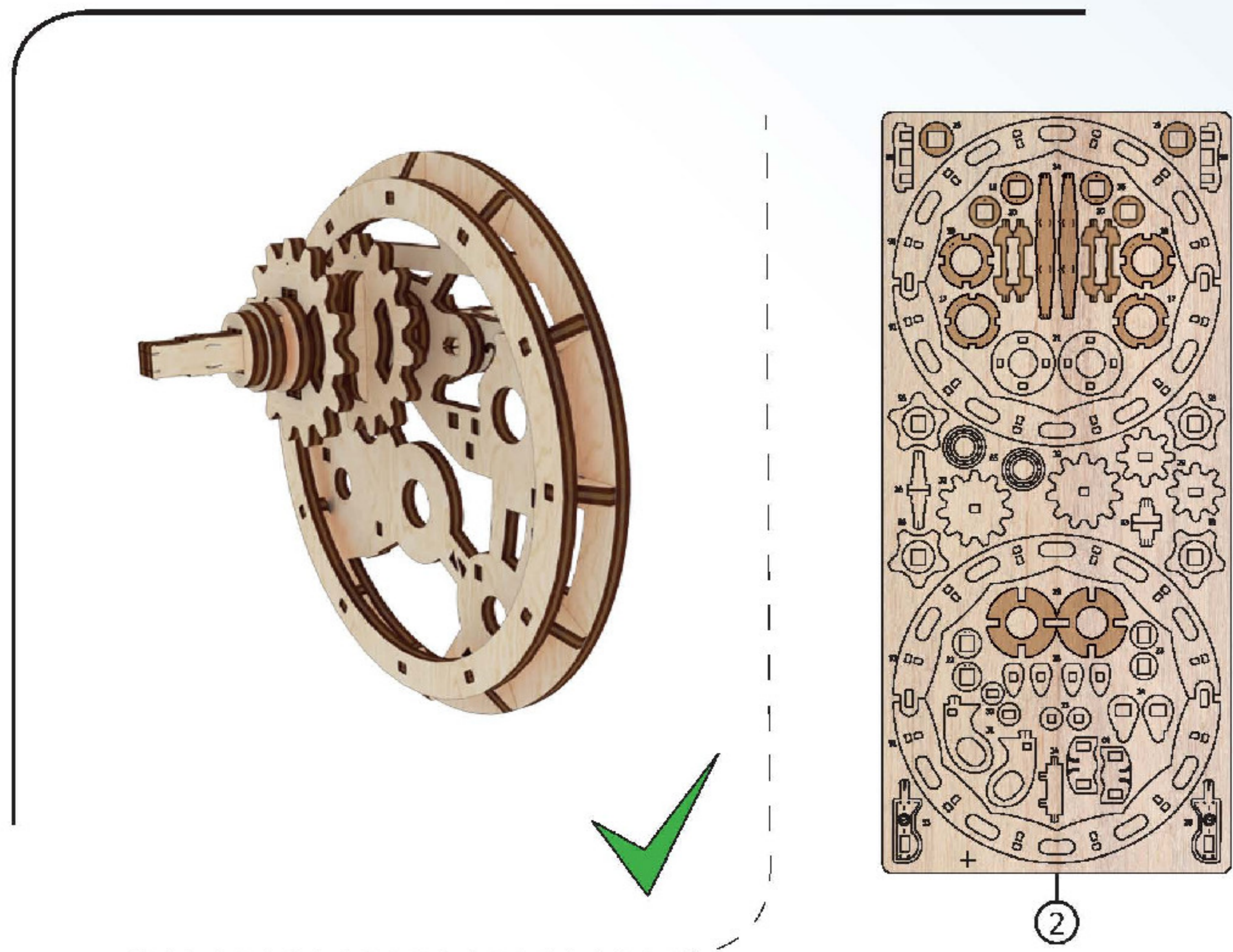

Mechanical models

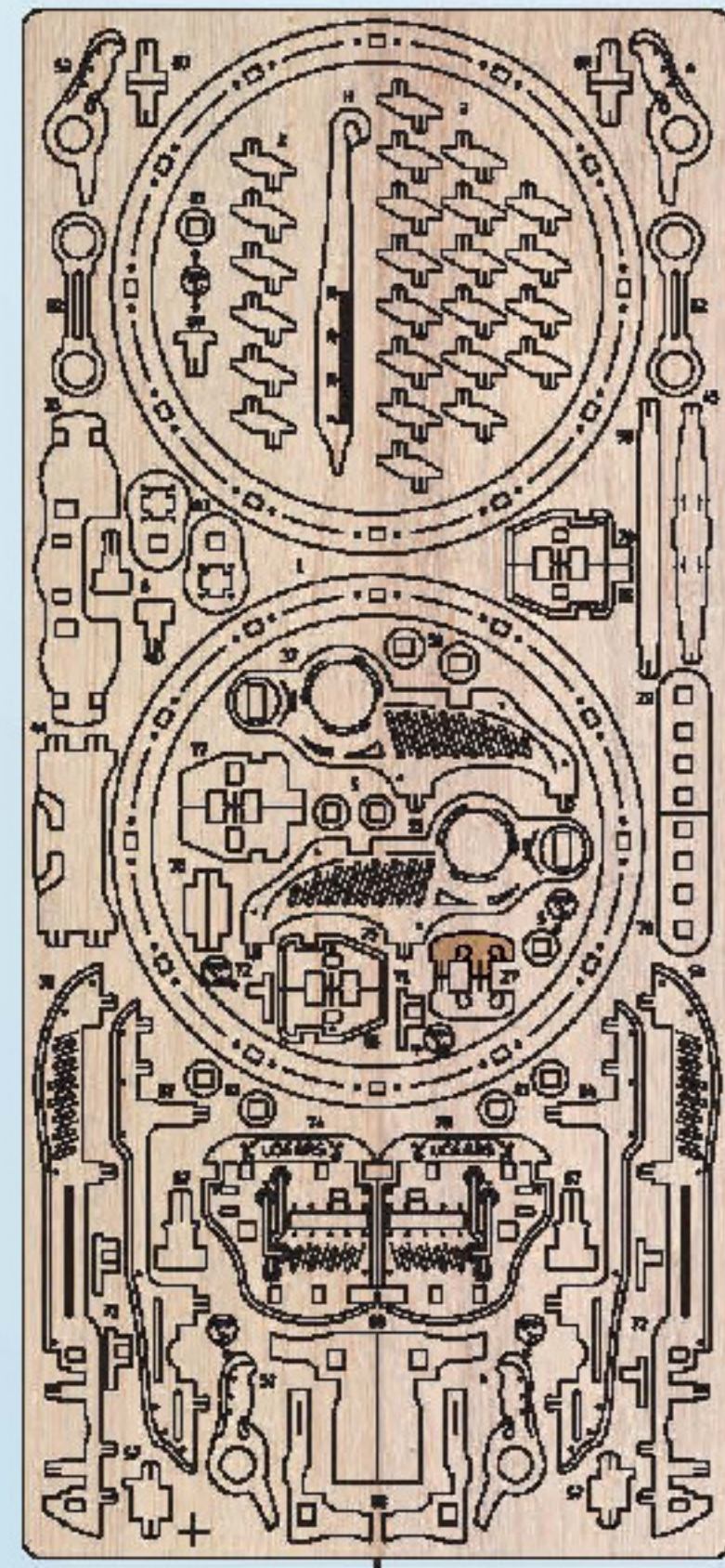

1

1

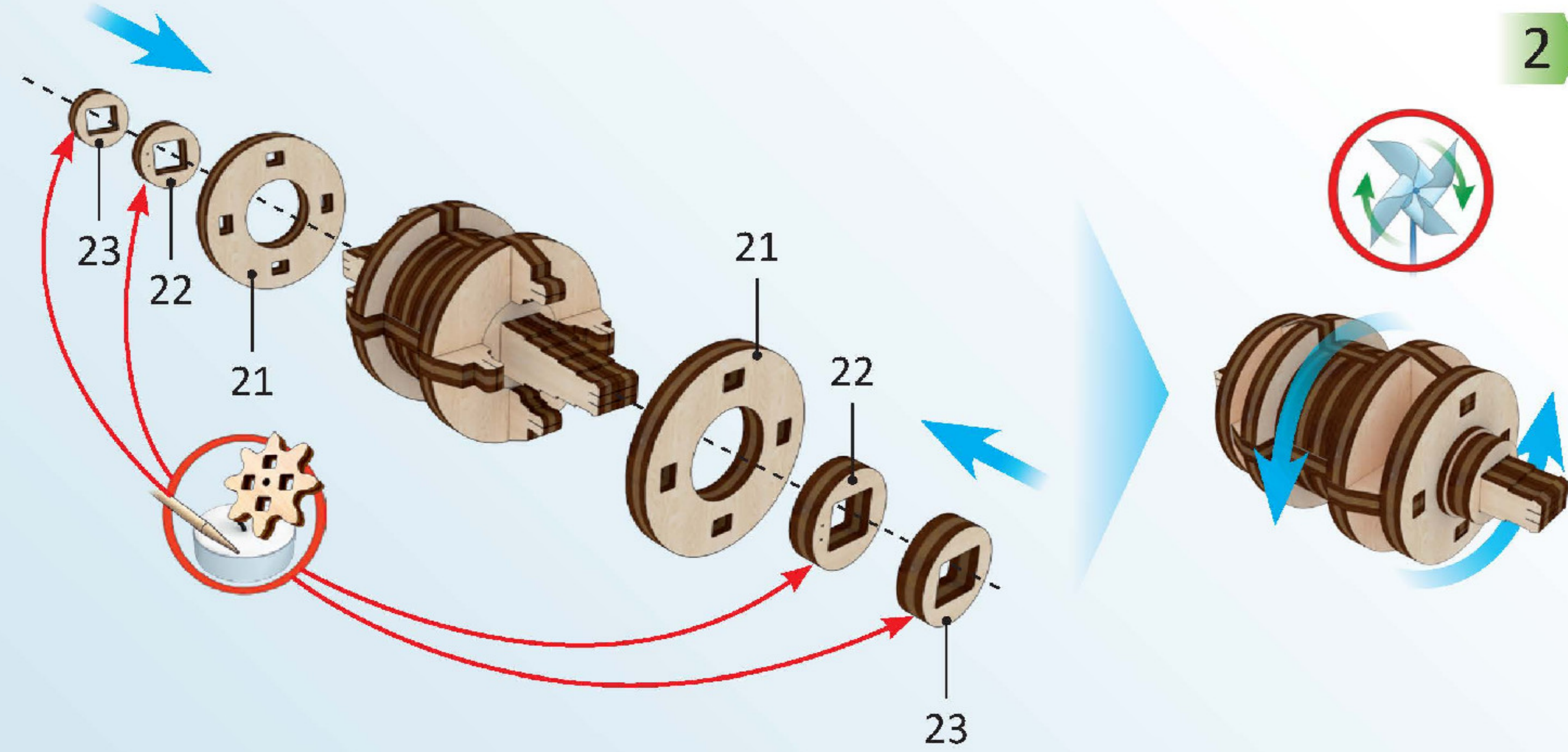

2

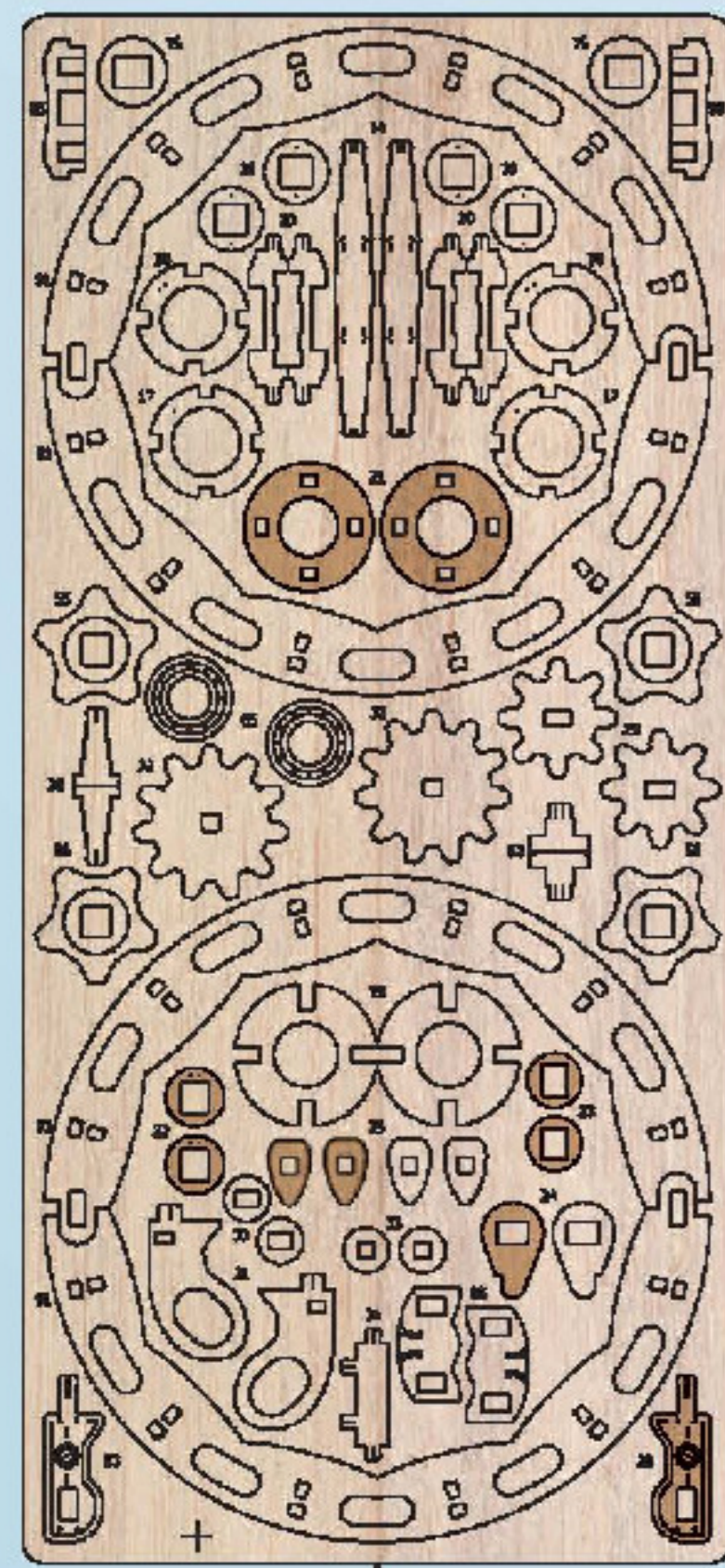
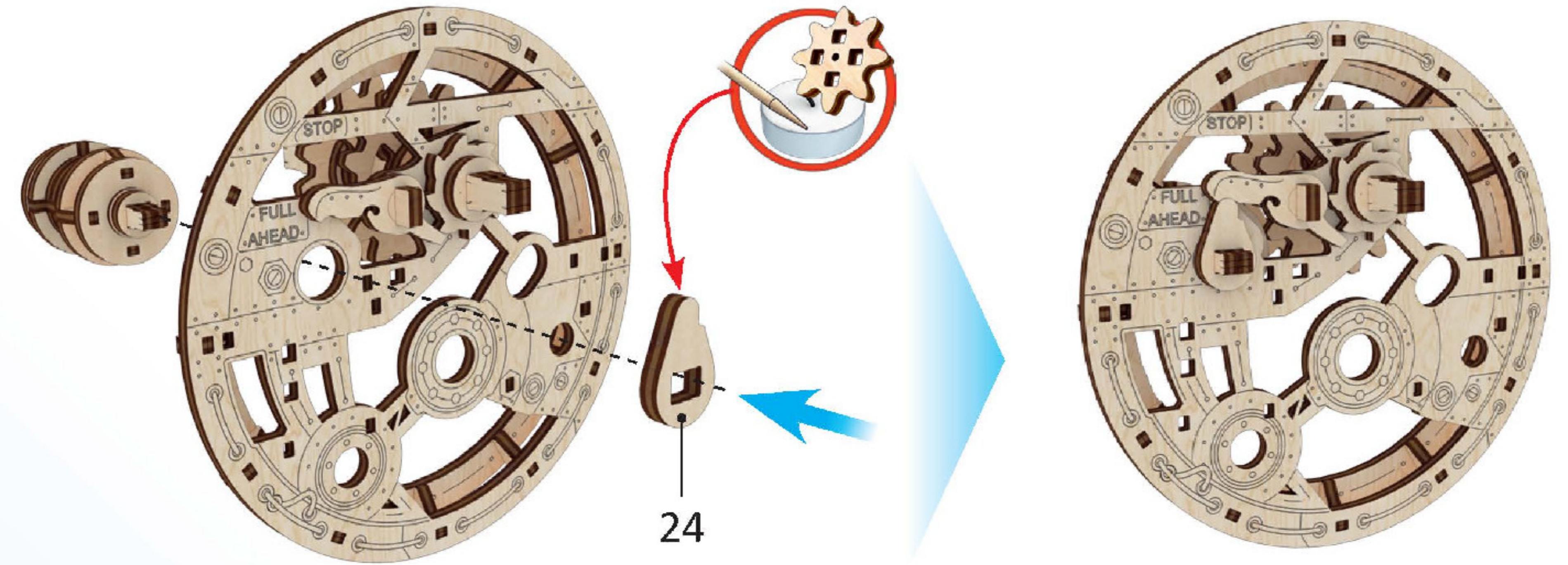

2

3

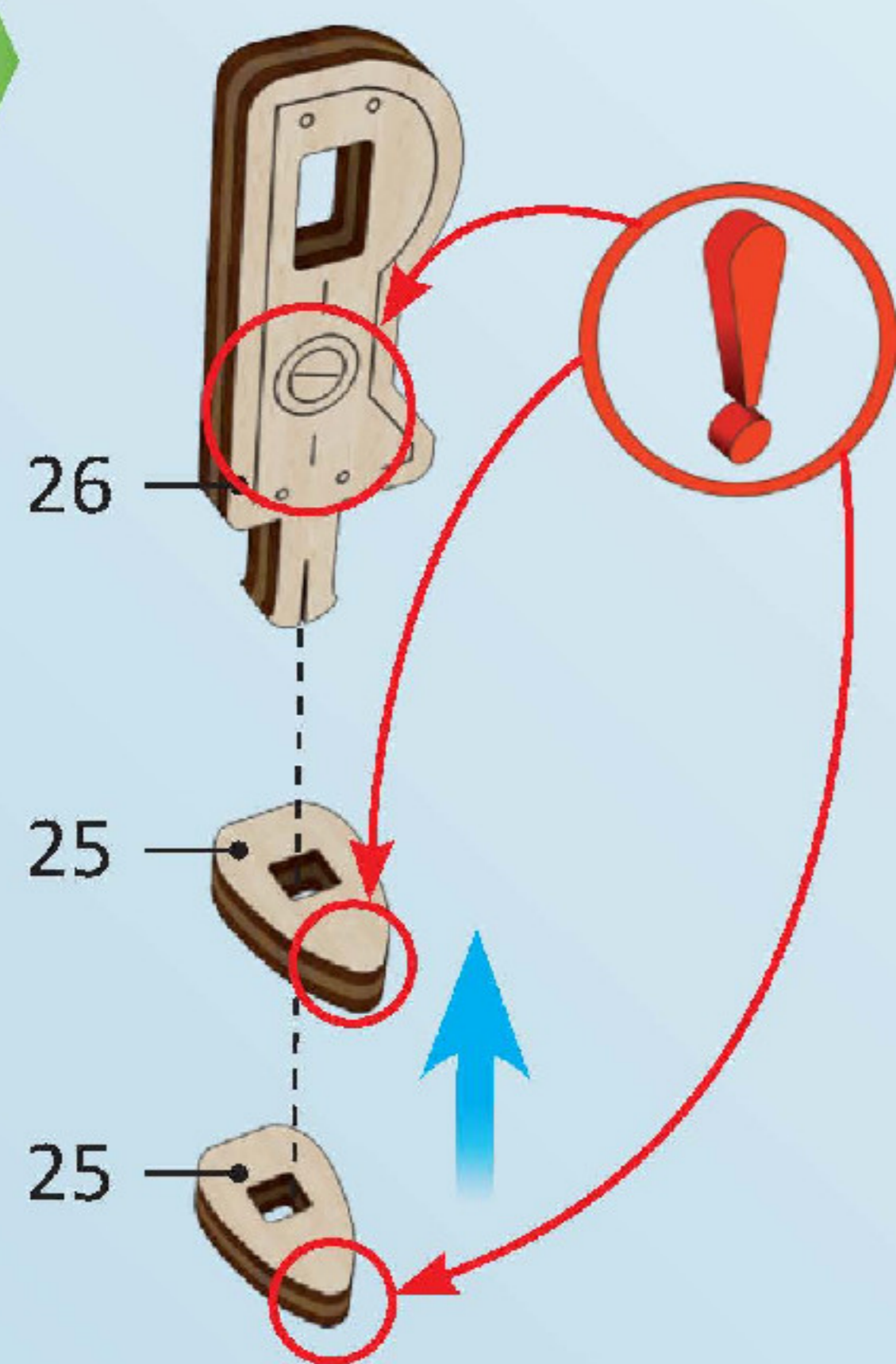

4

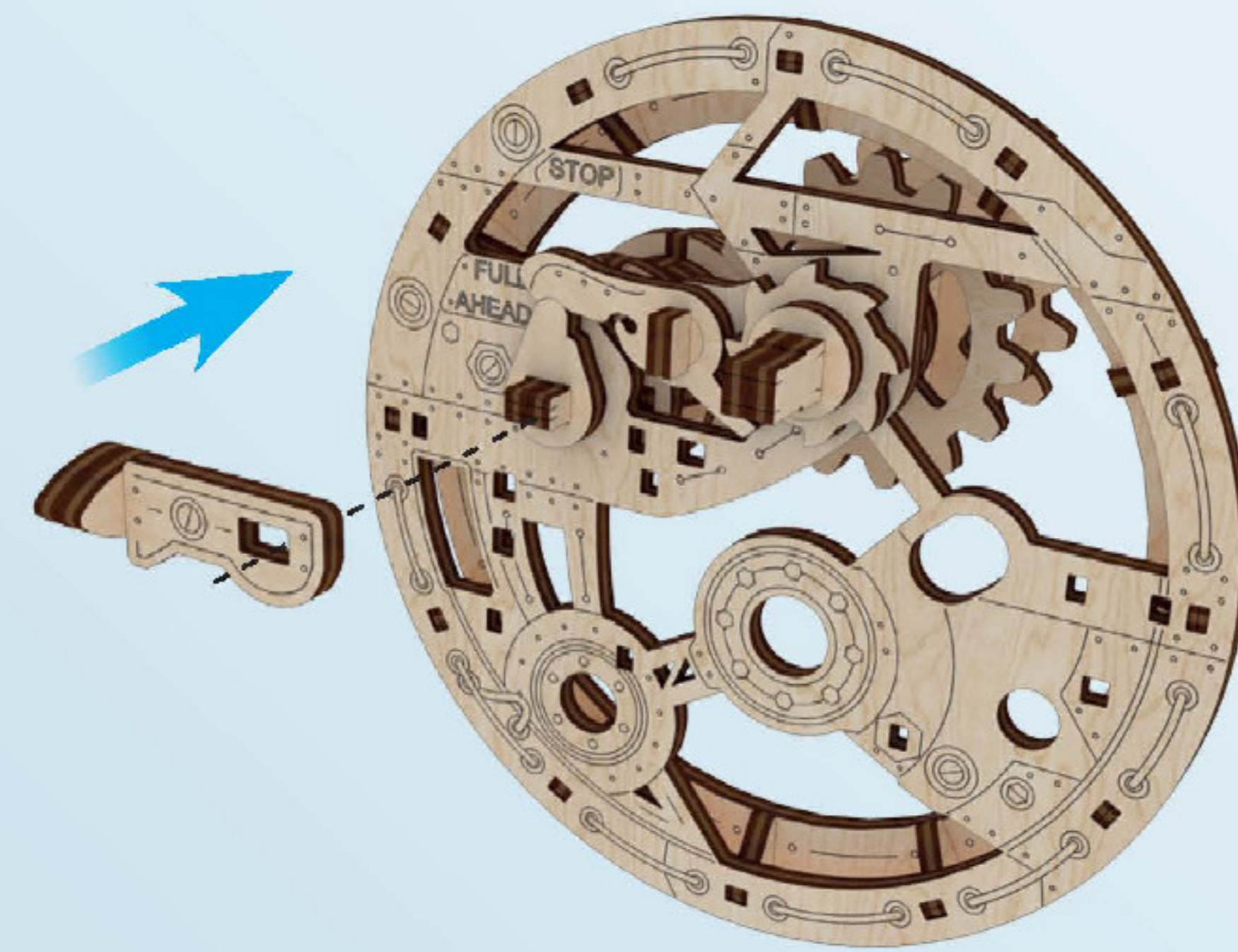

5

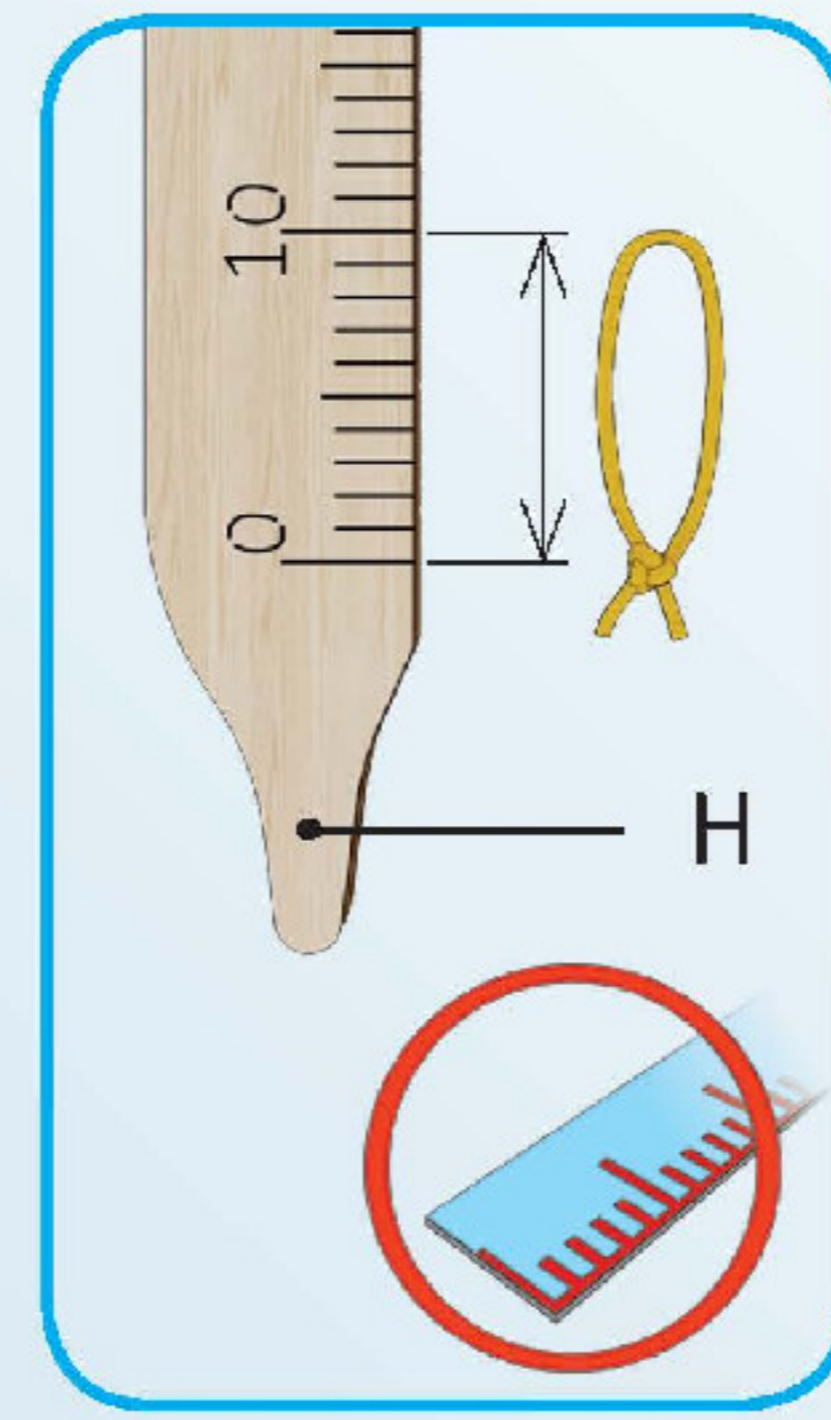

6

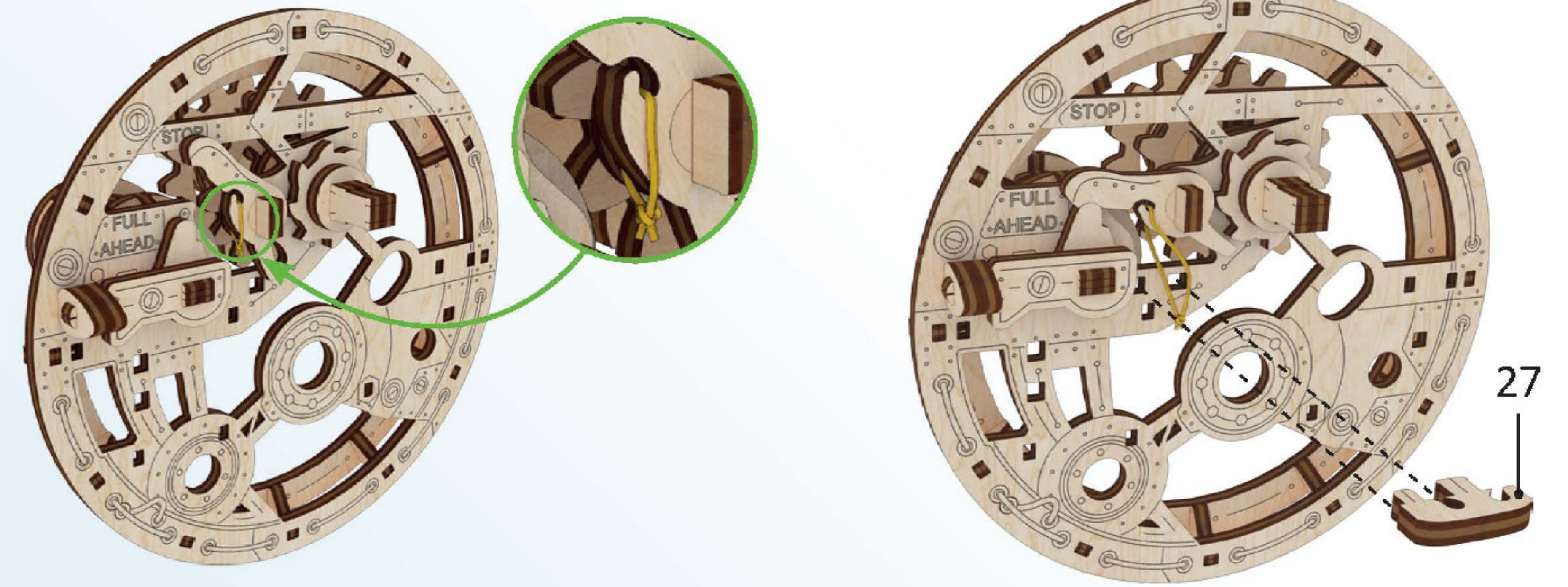

27

6

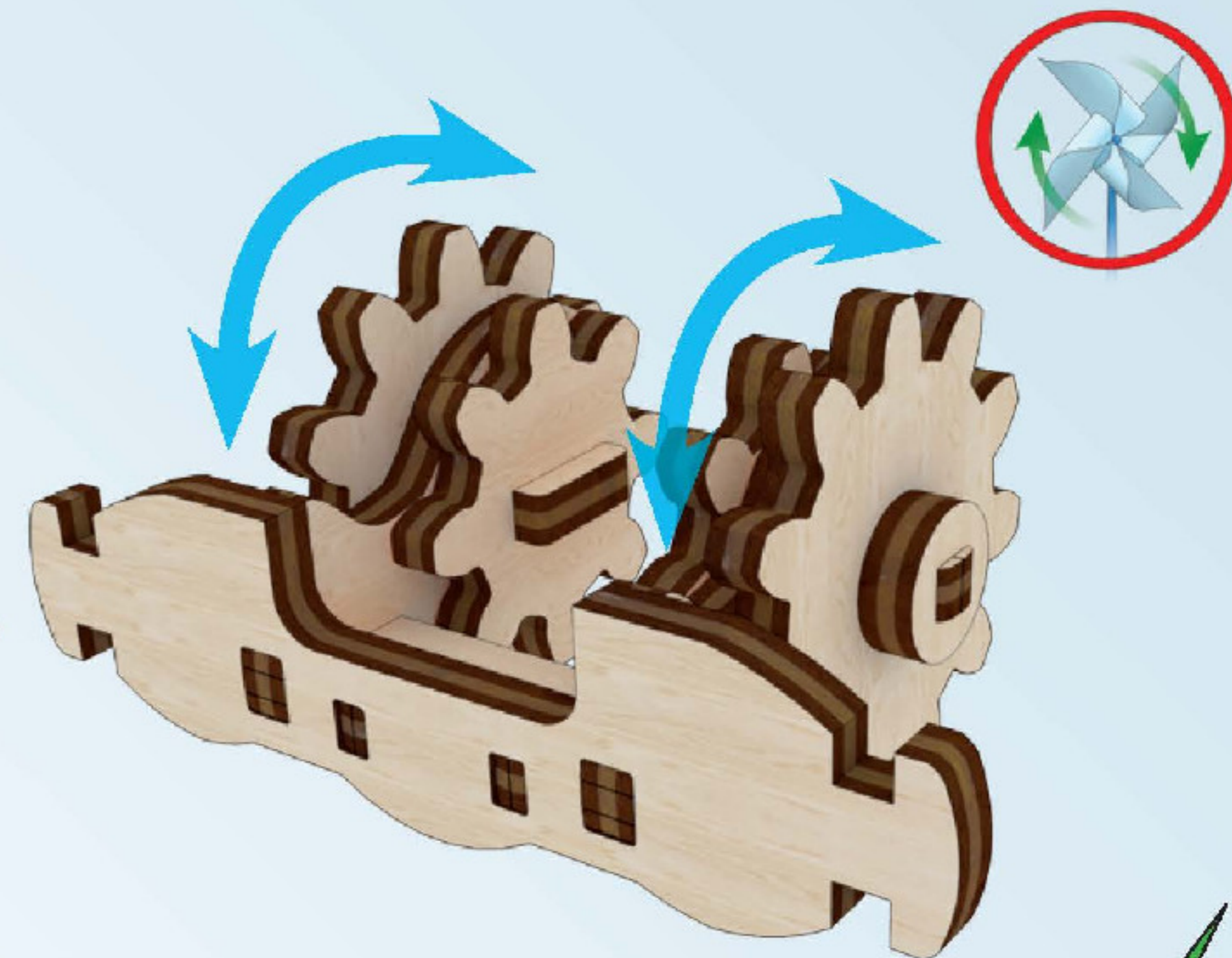
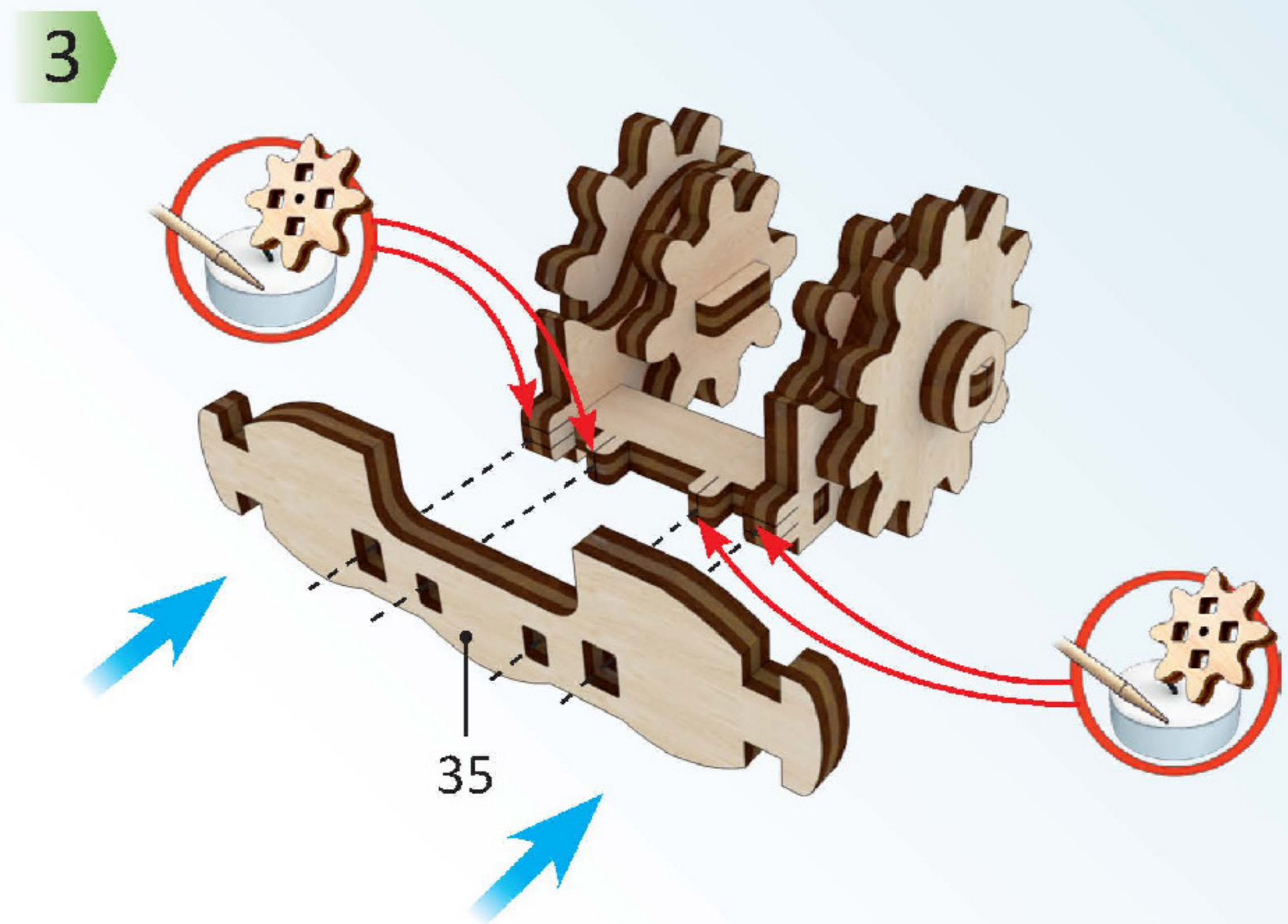
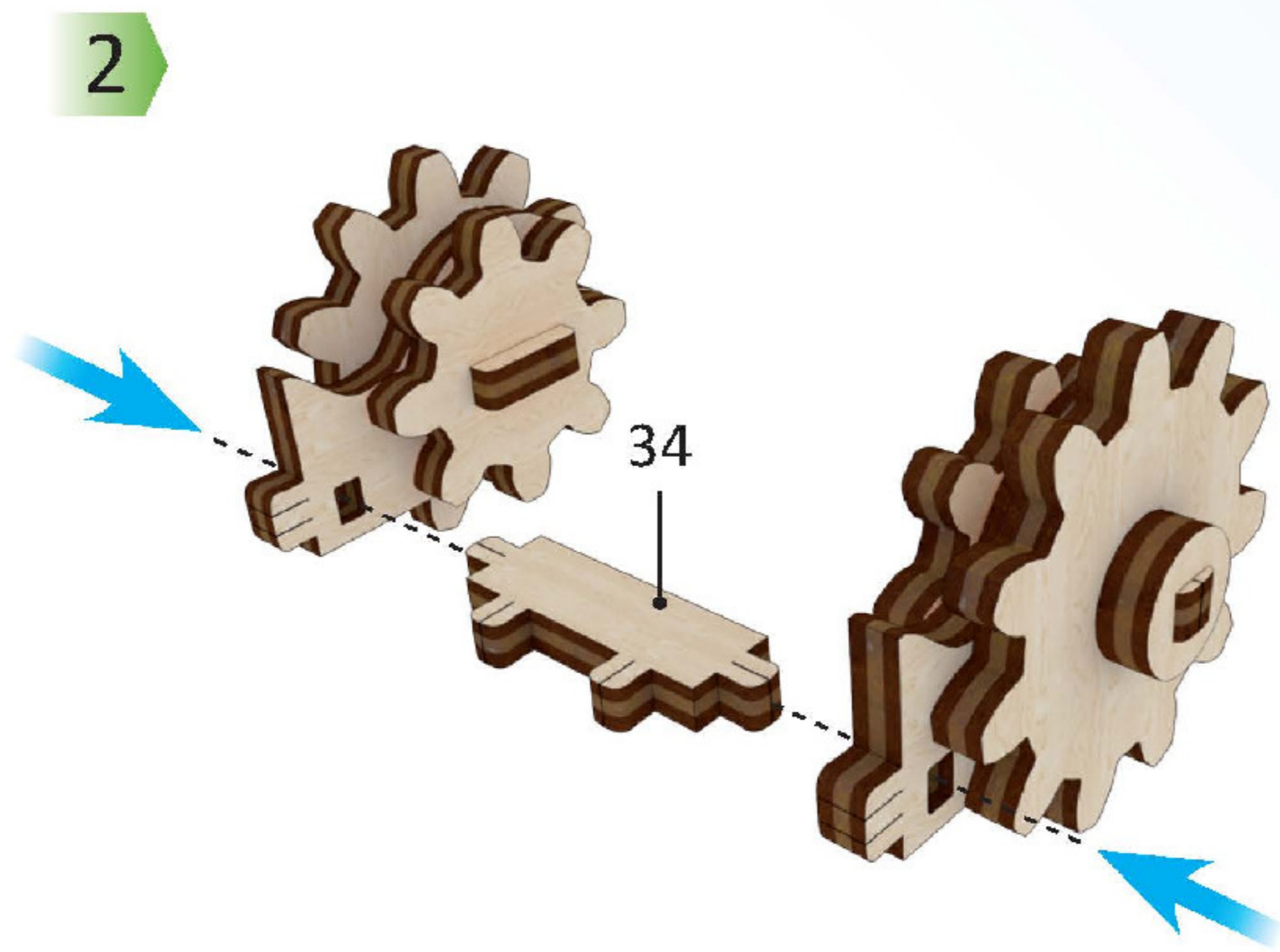
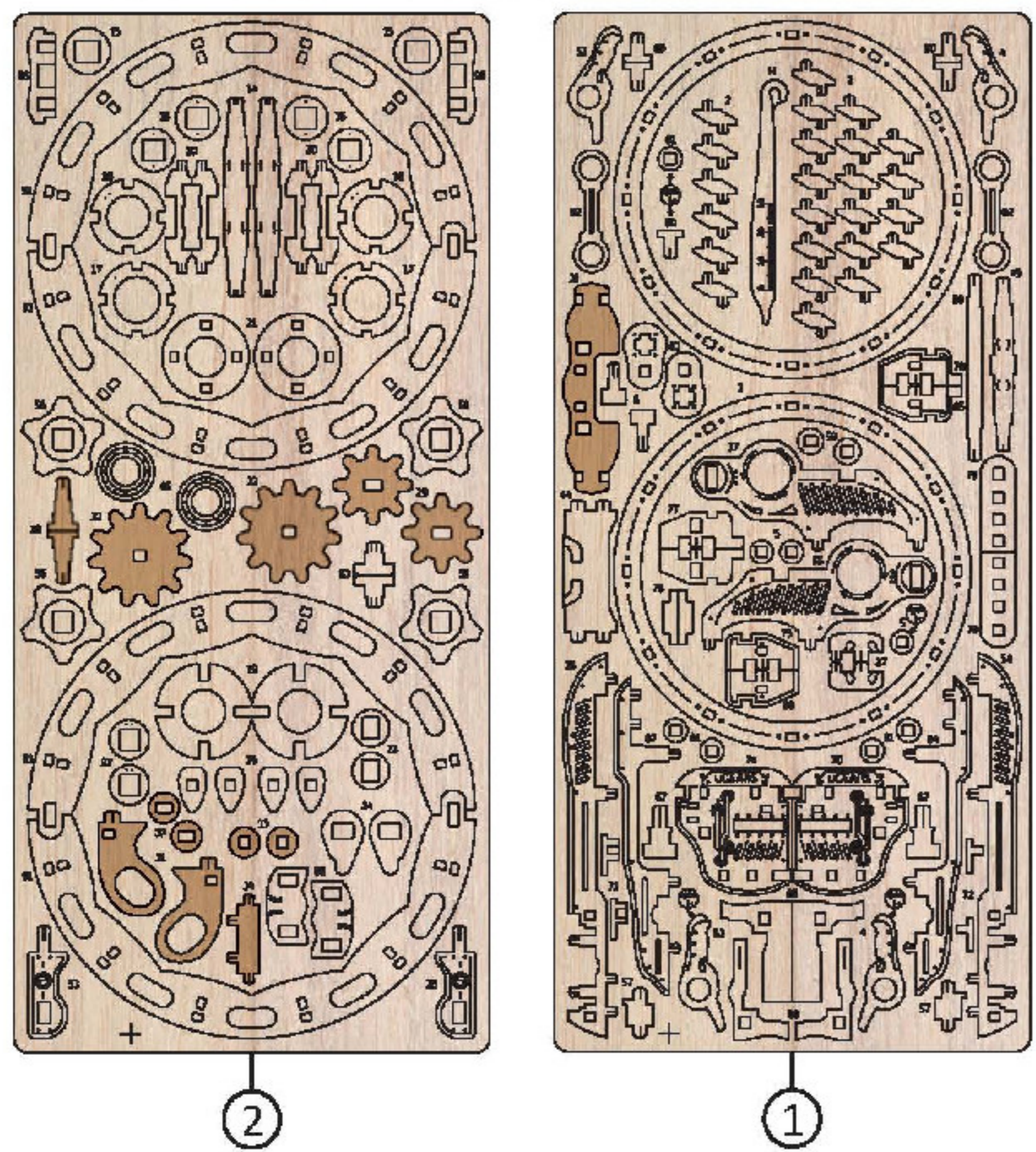
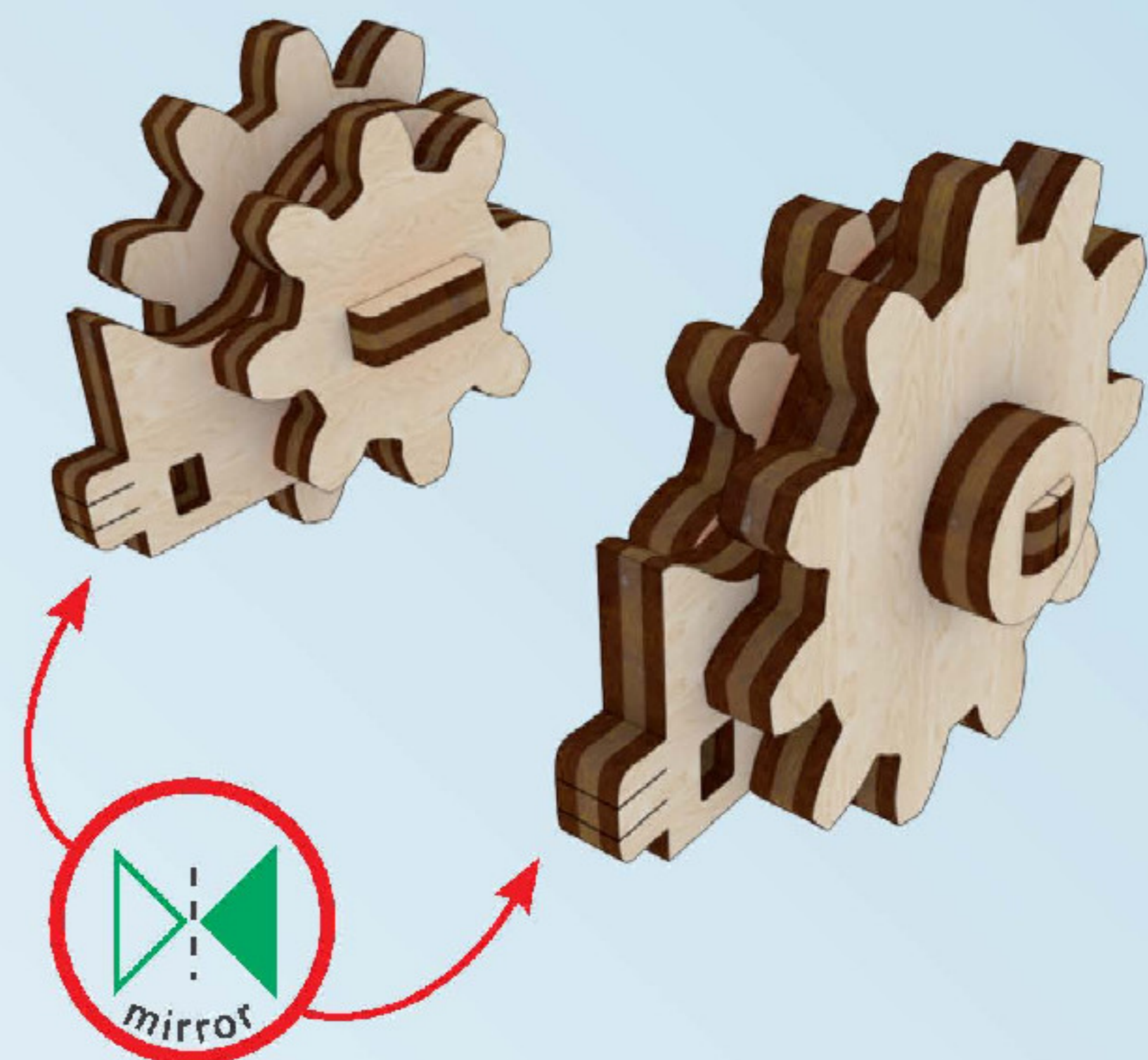
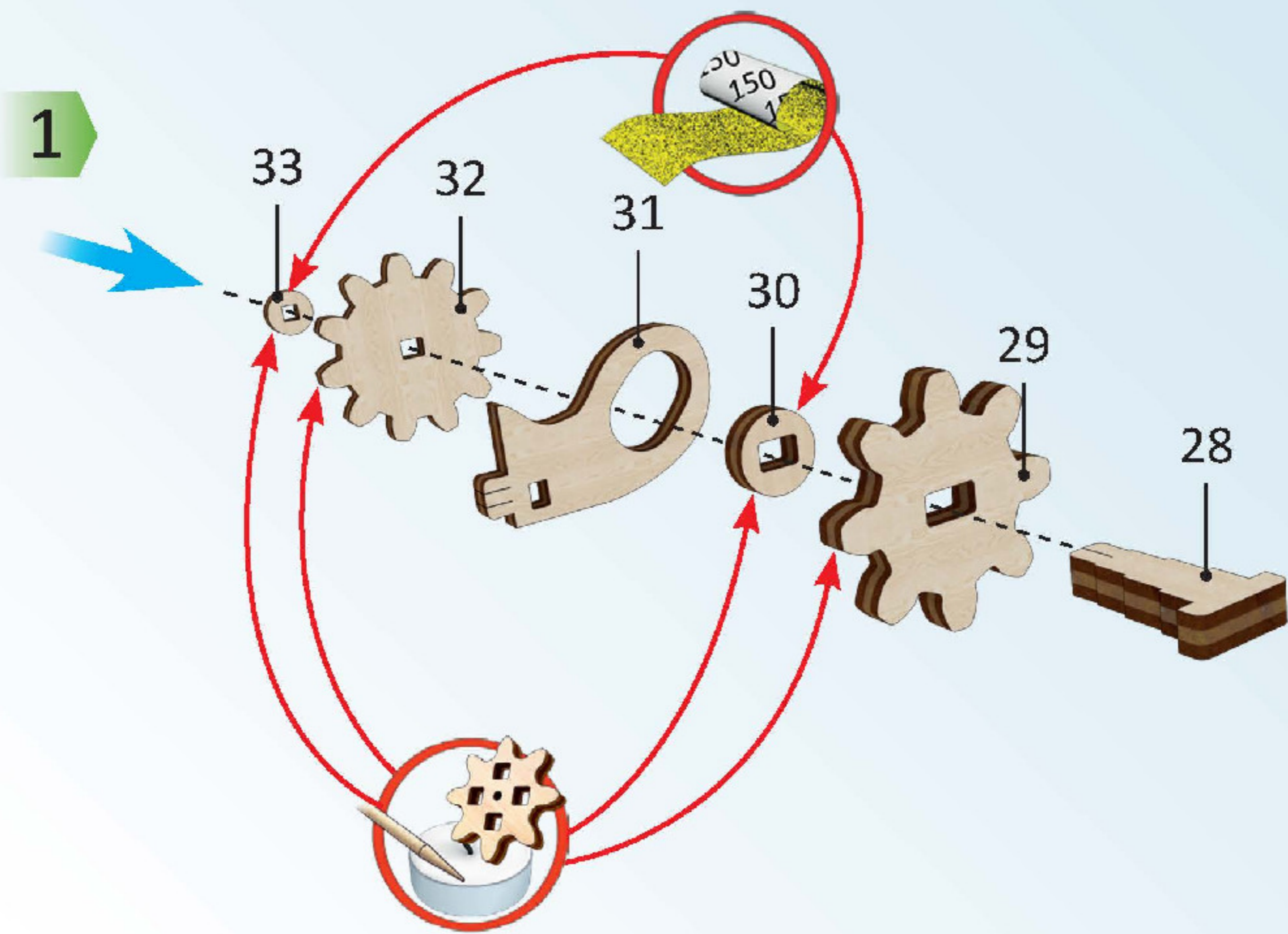
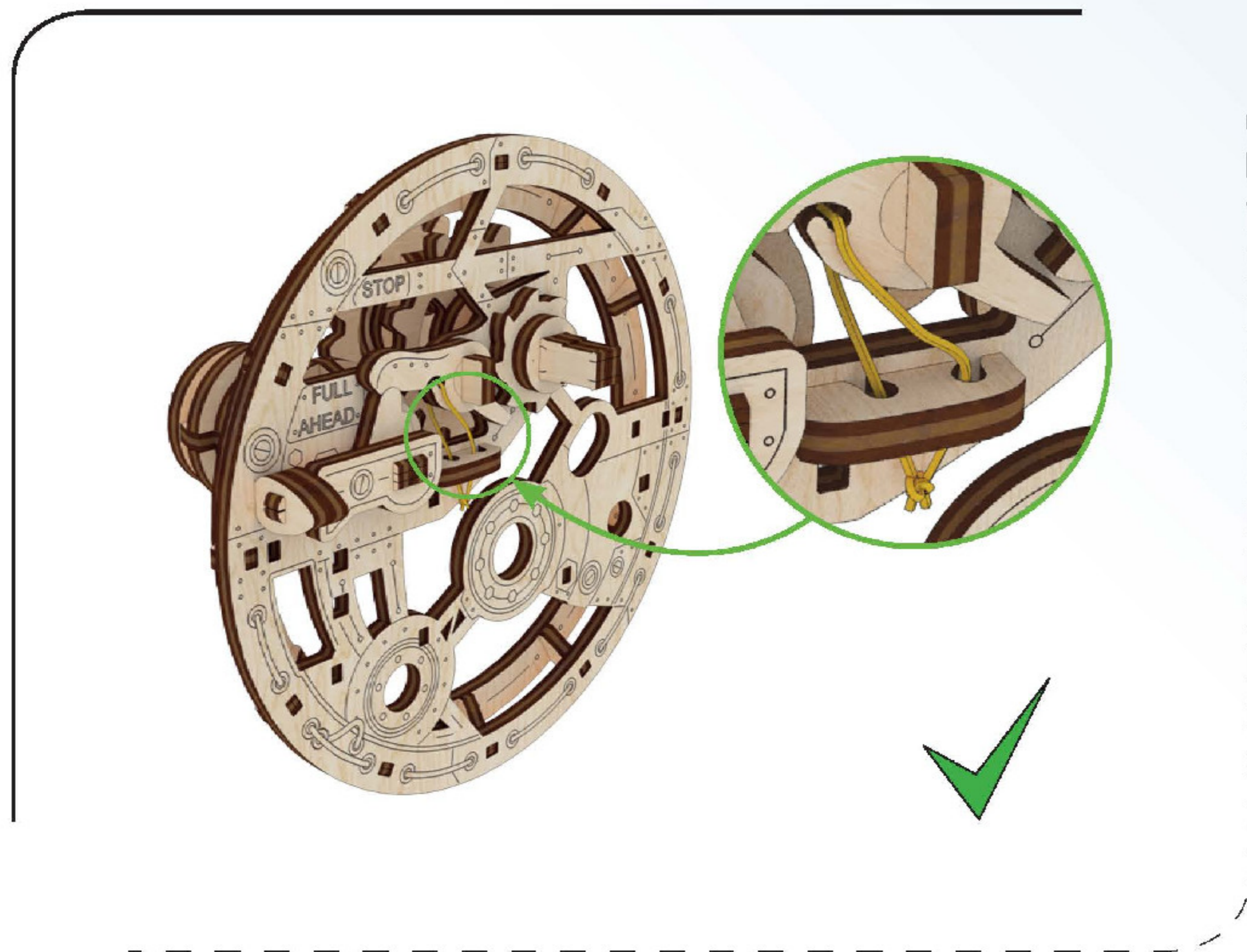

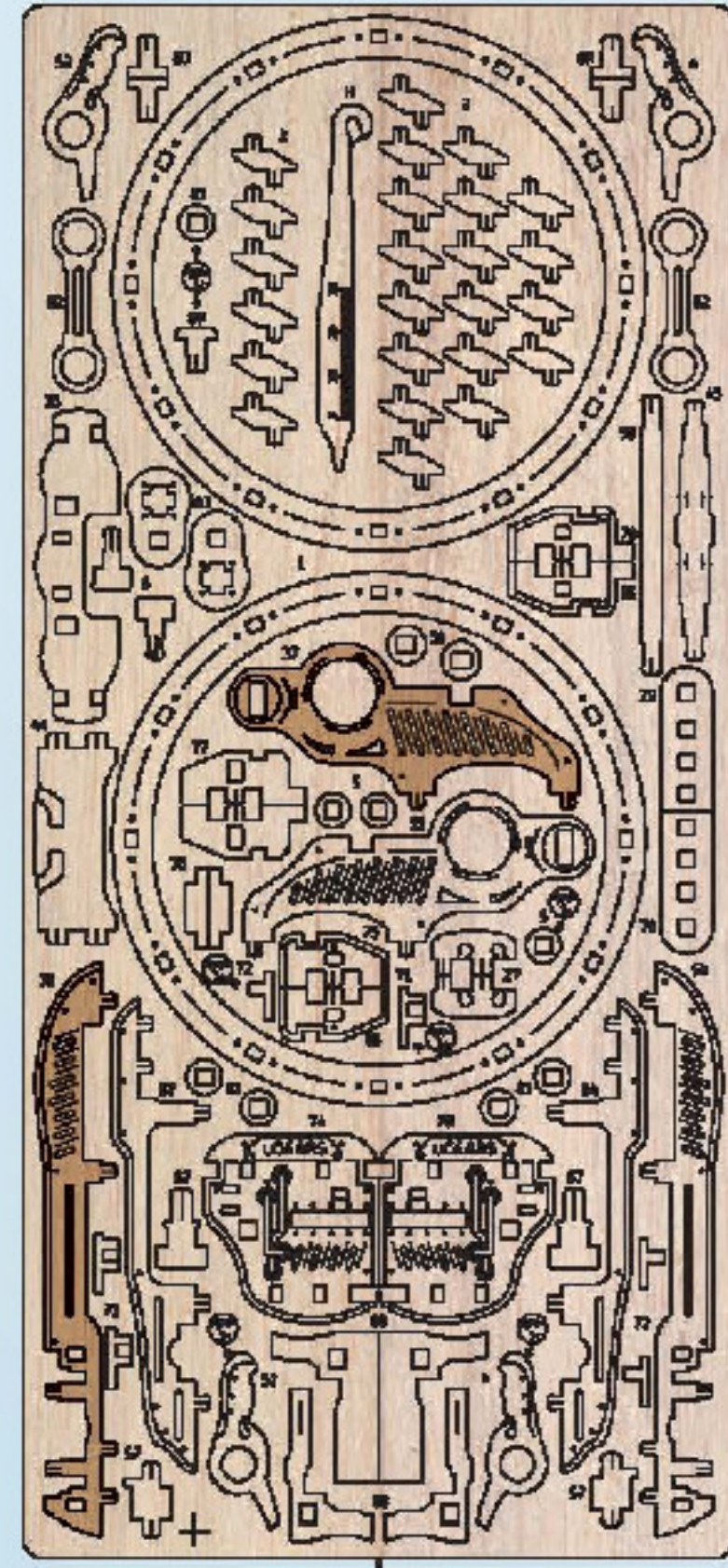

1

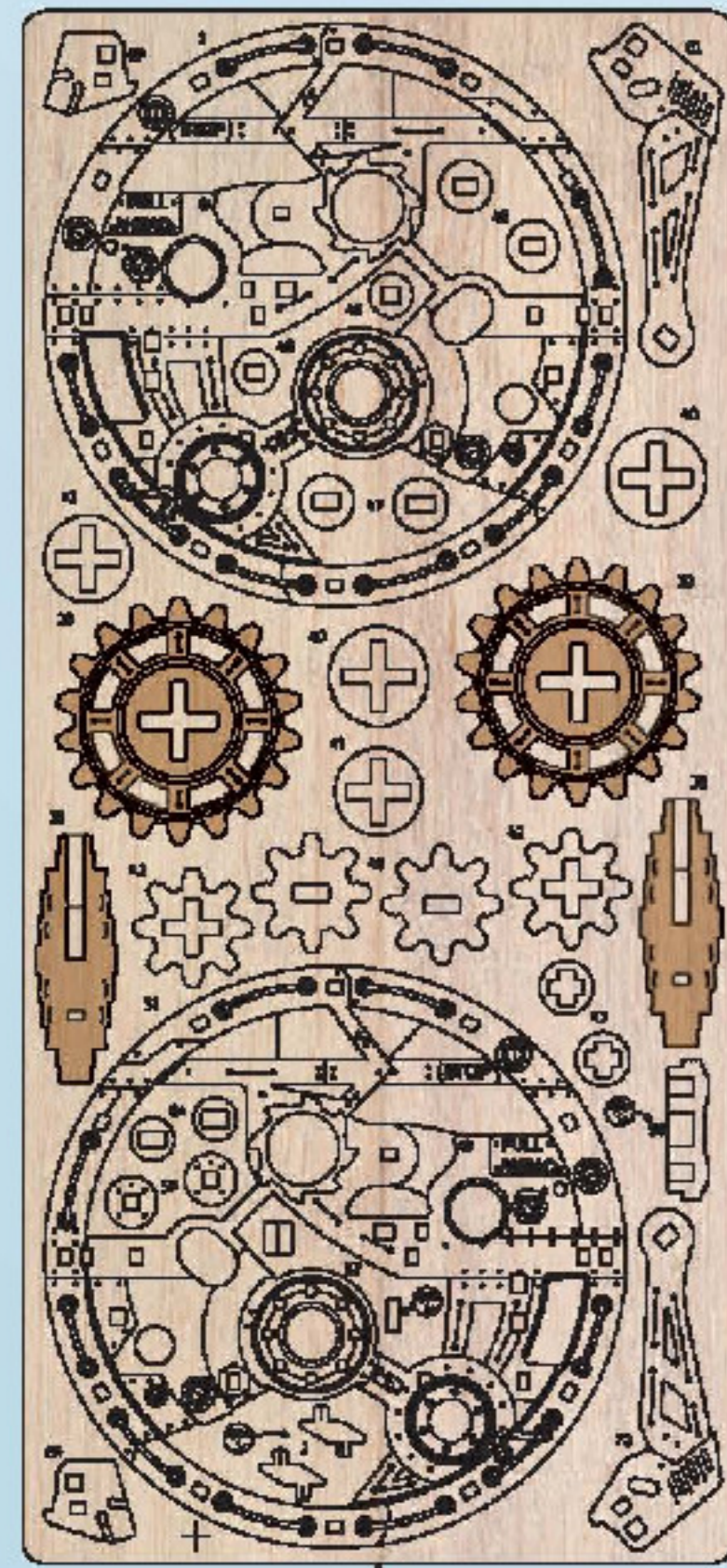
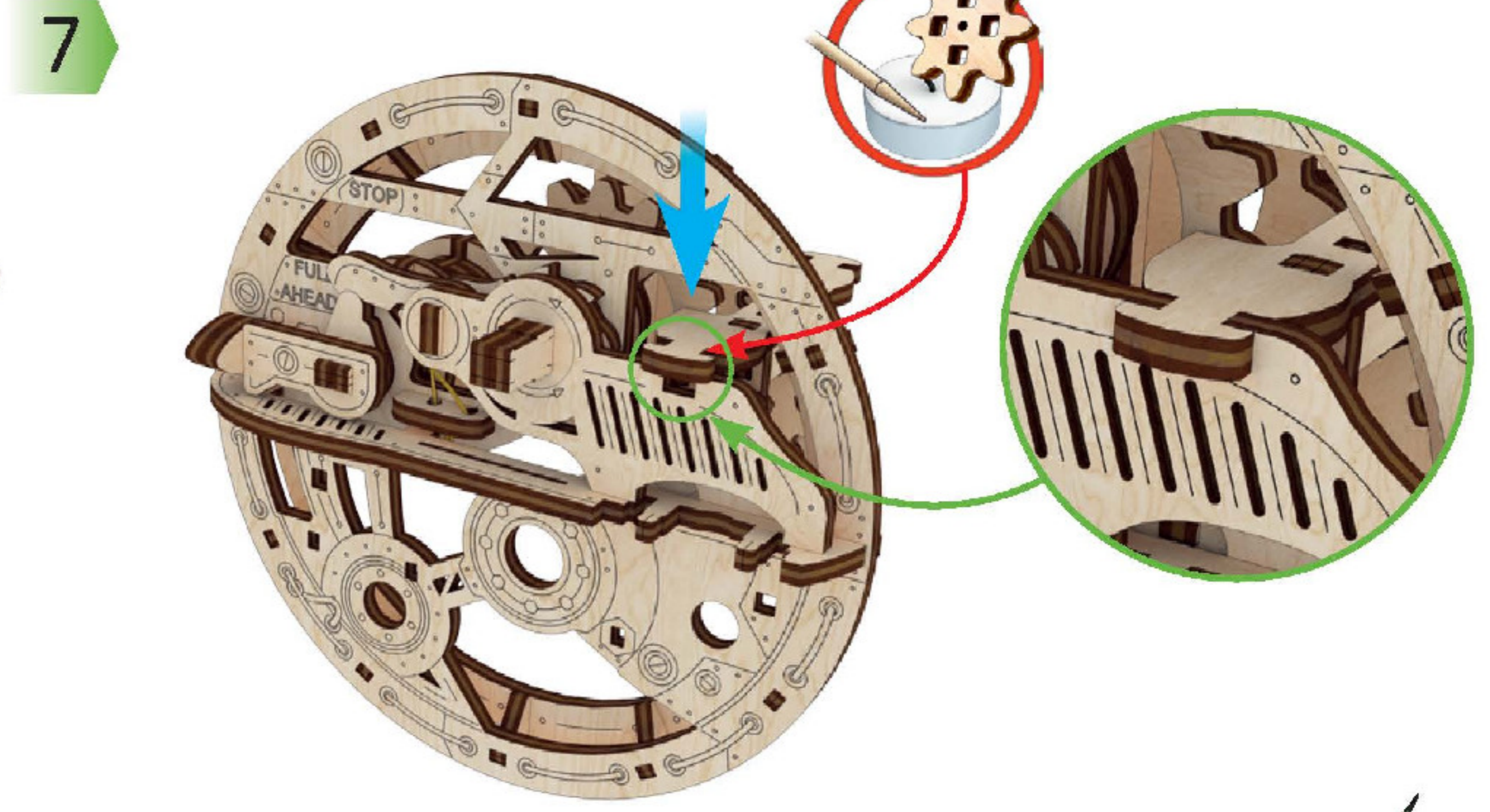
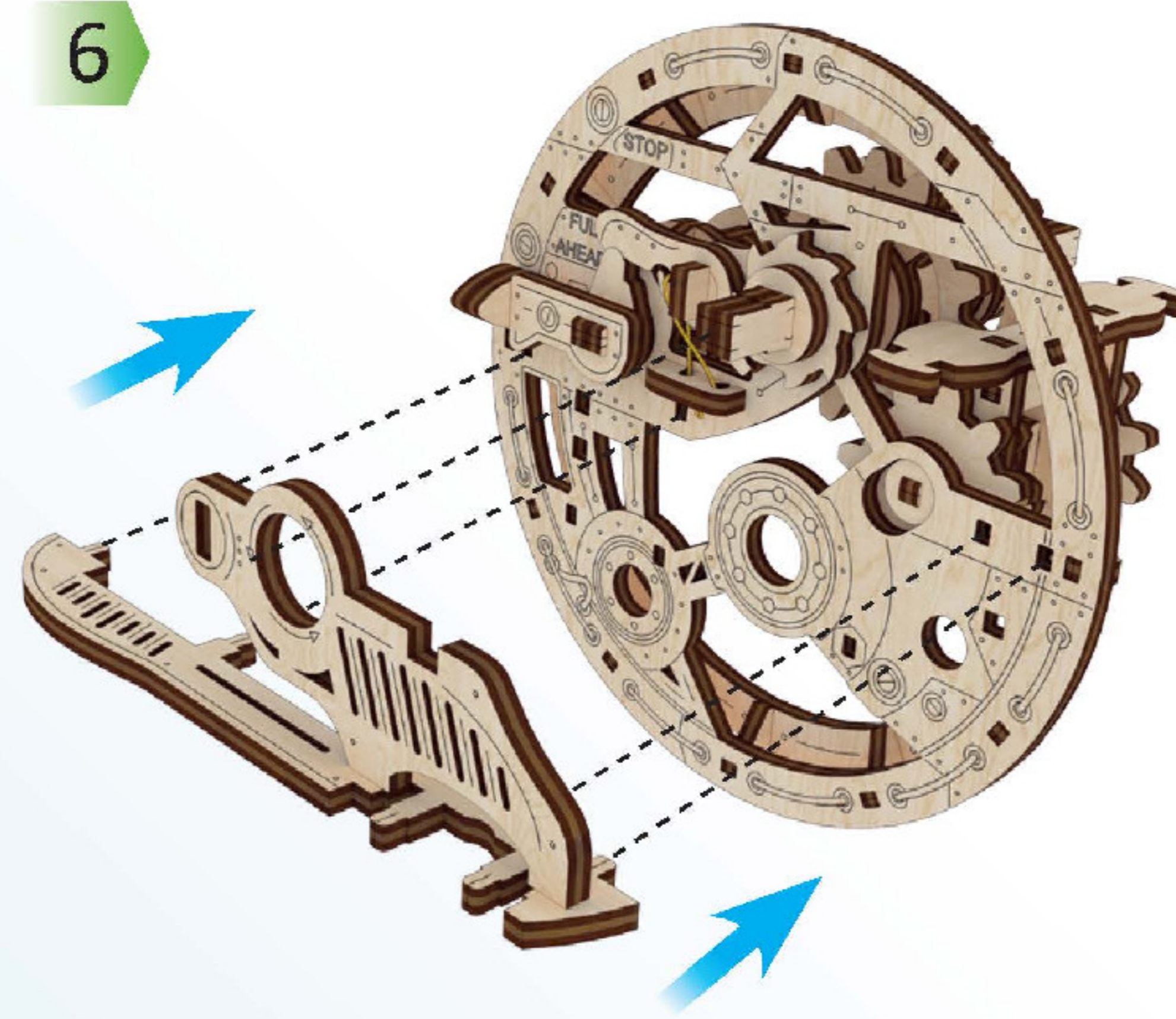
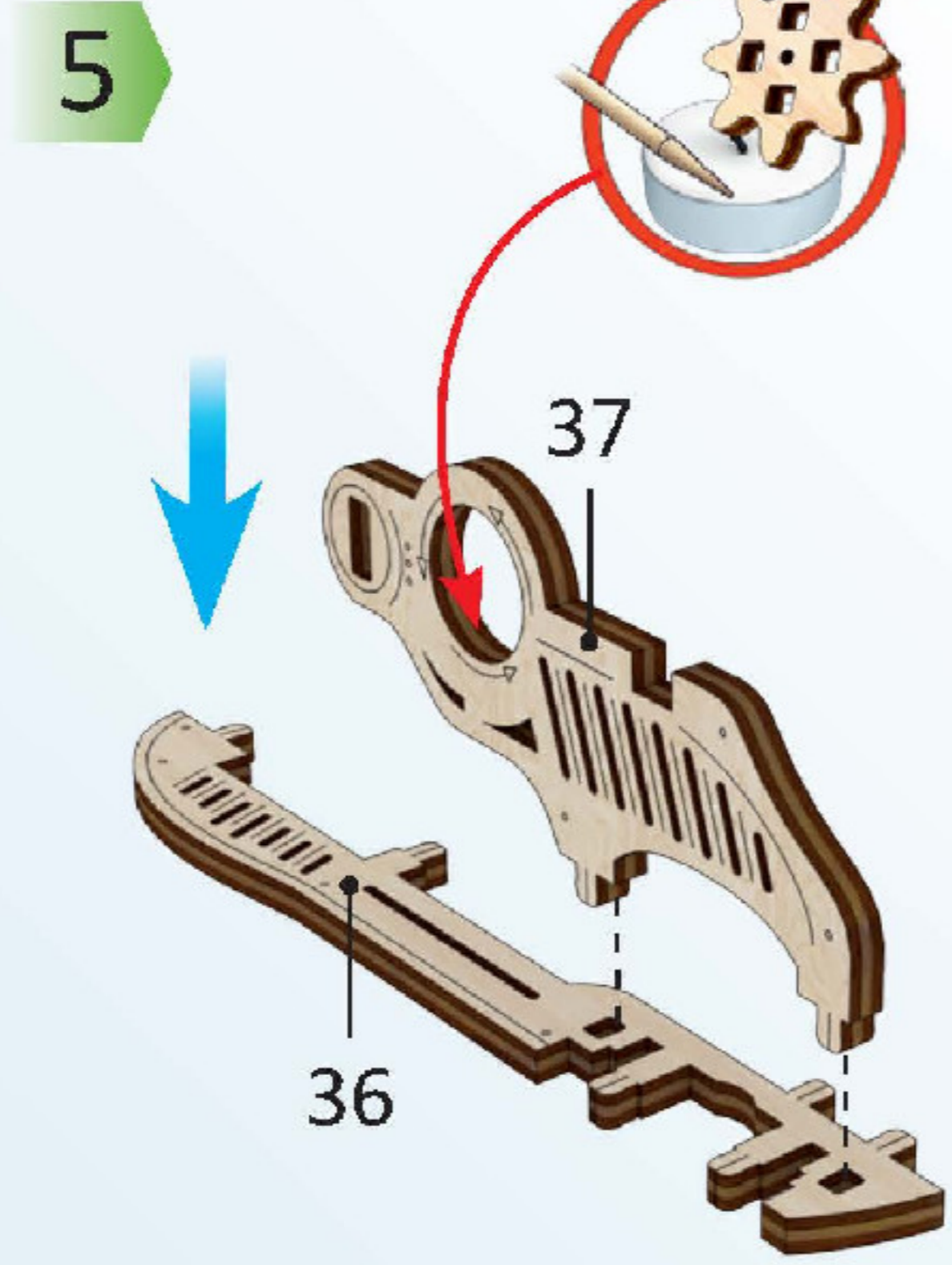
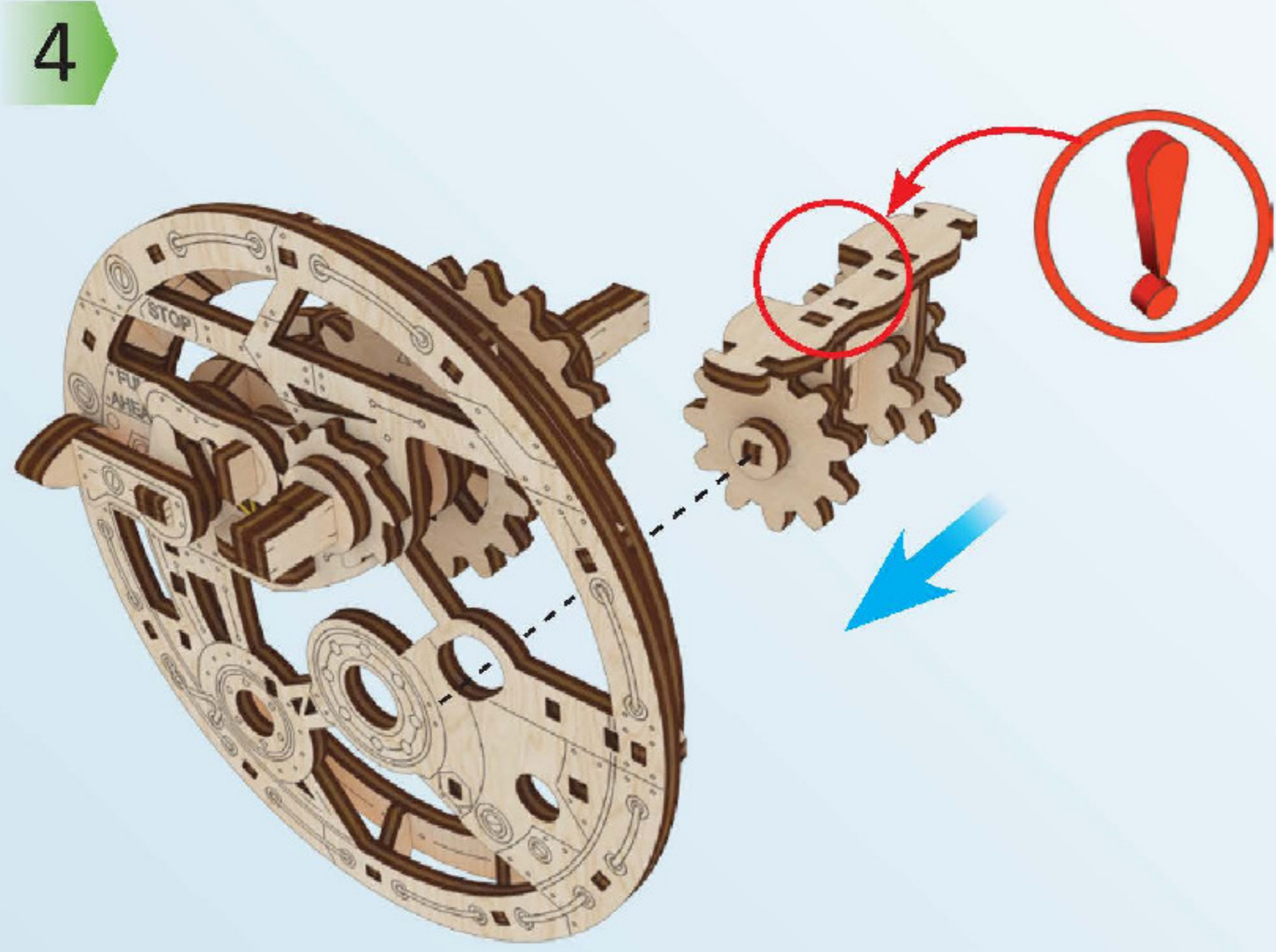

3

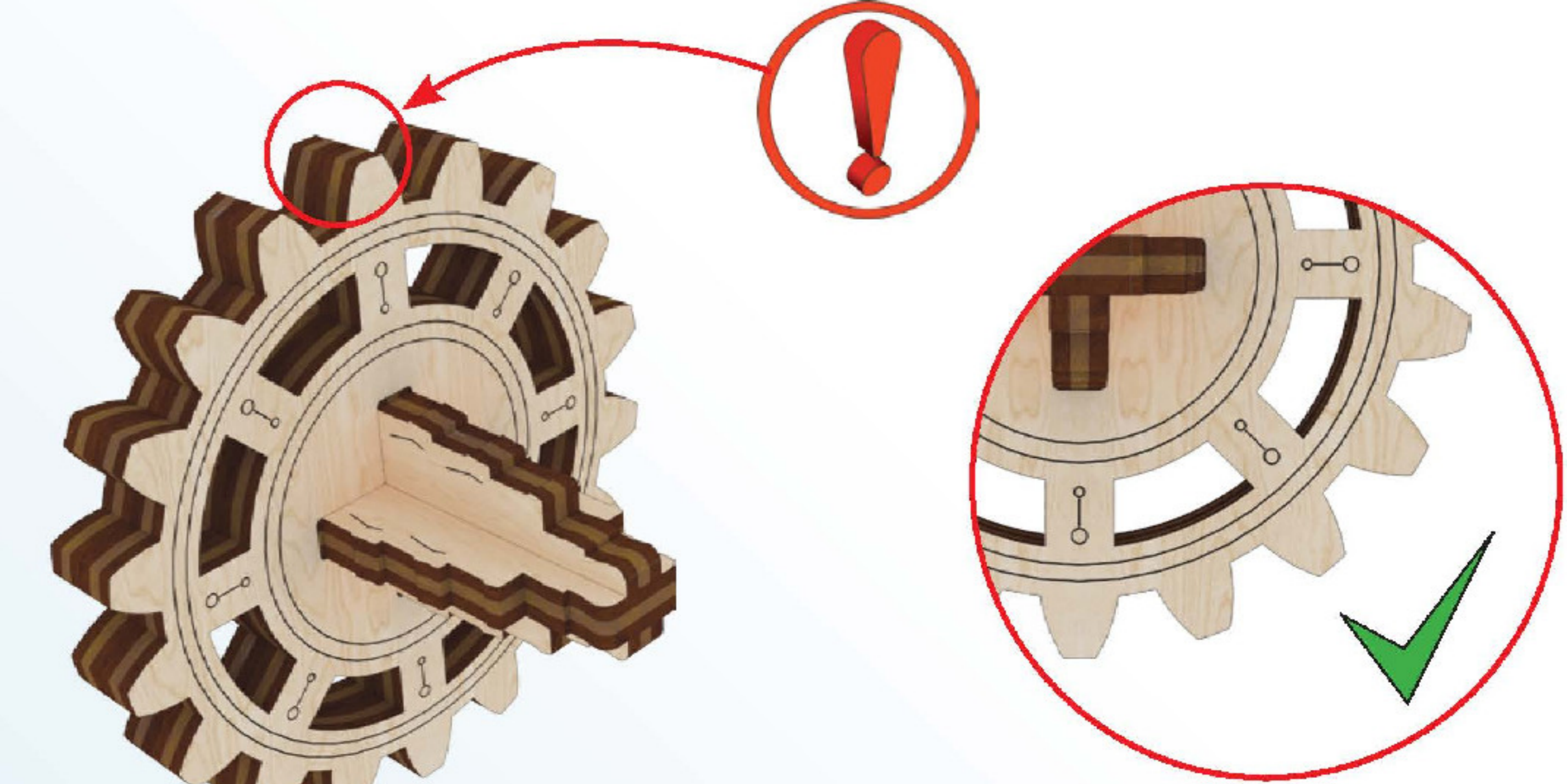
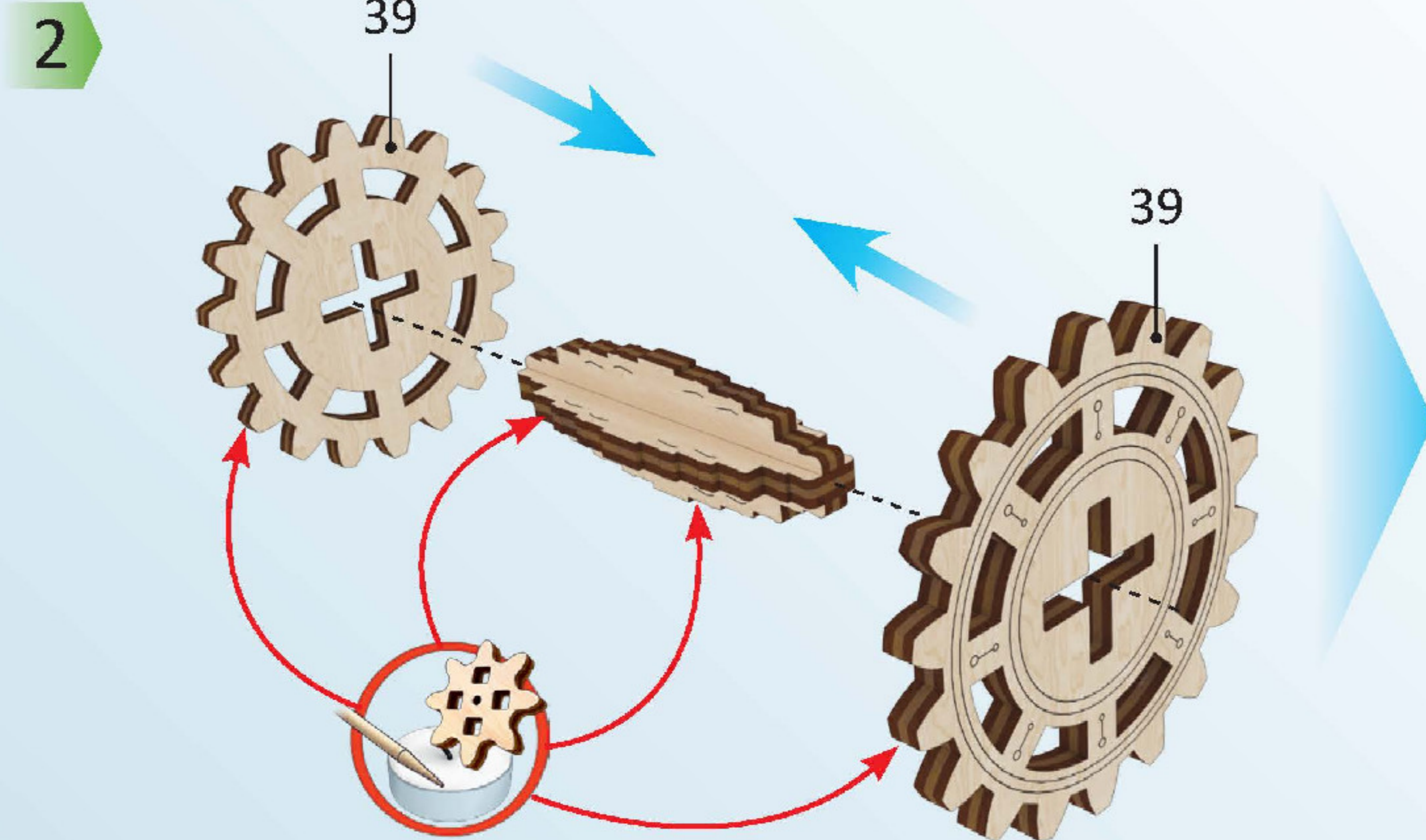
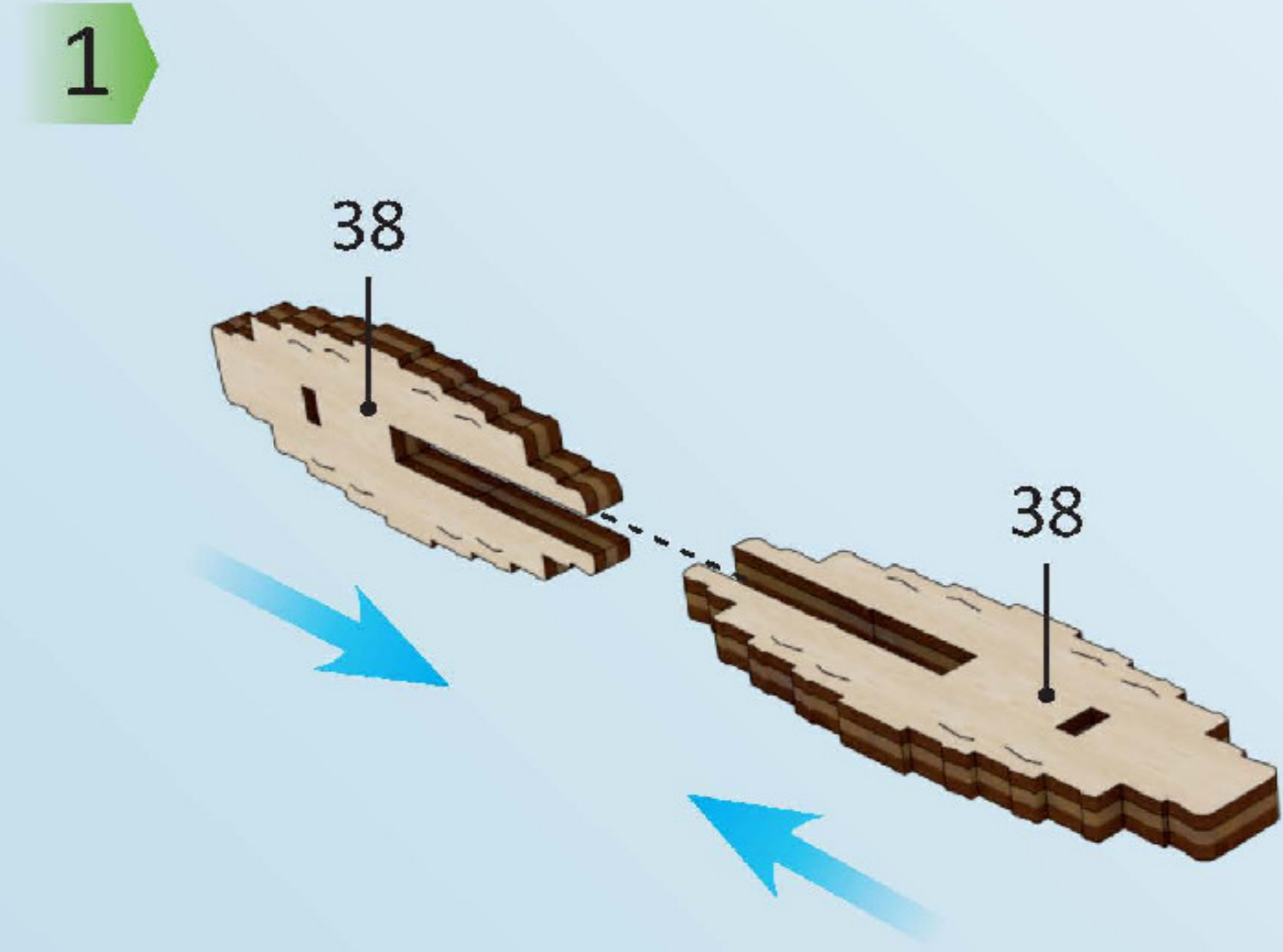

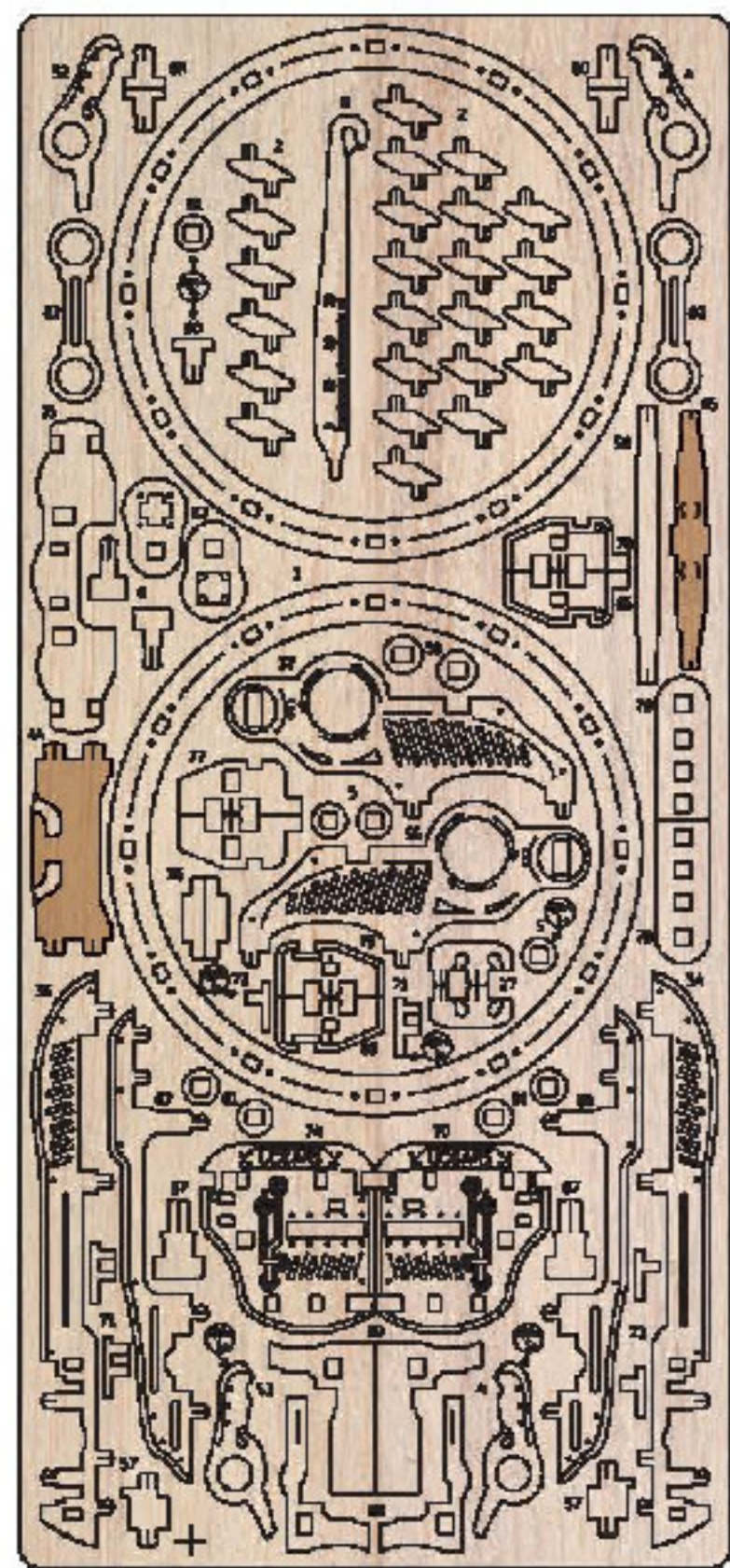

1

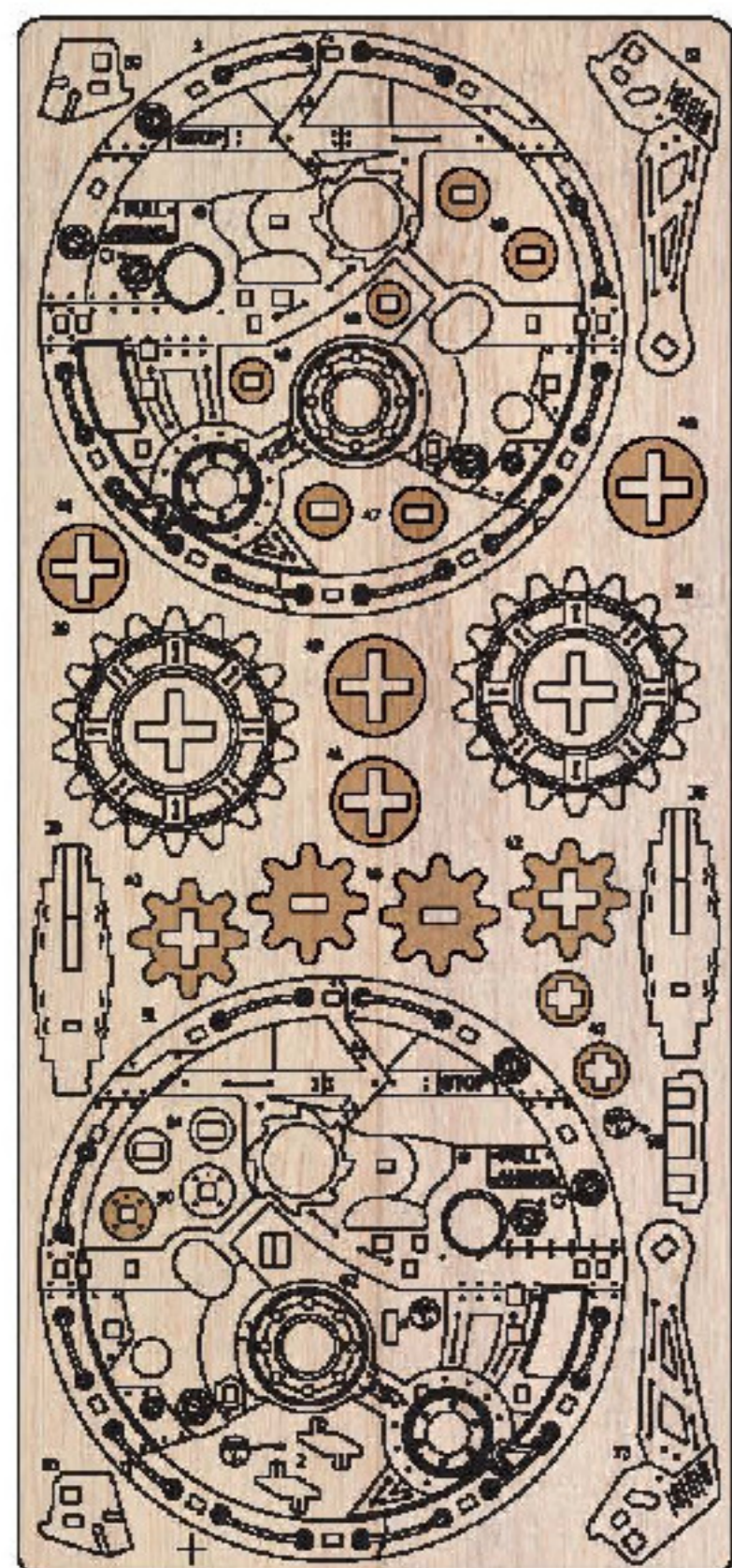
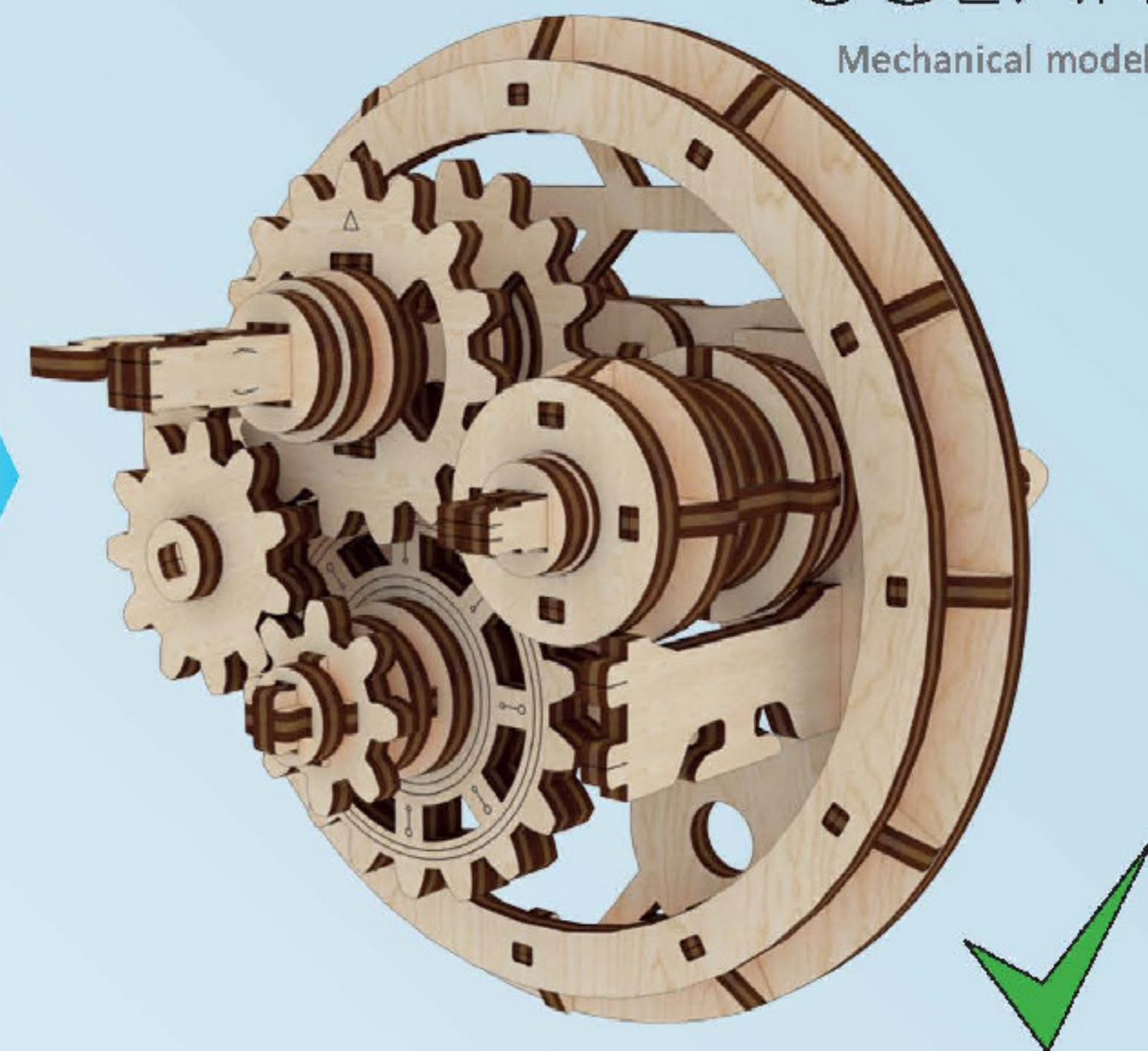
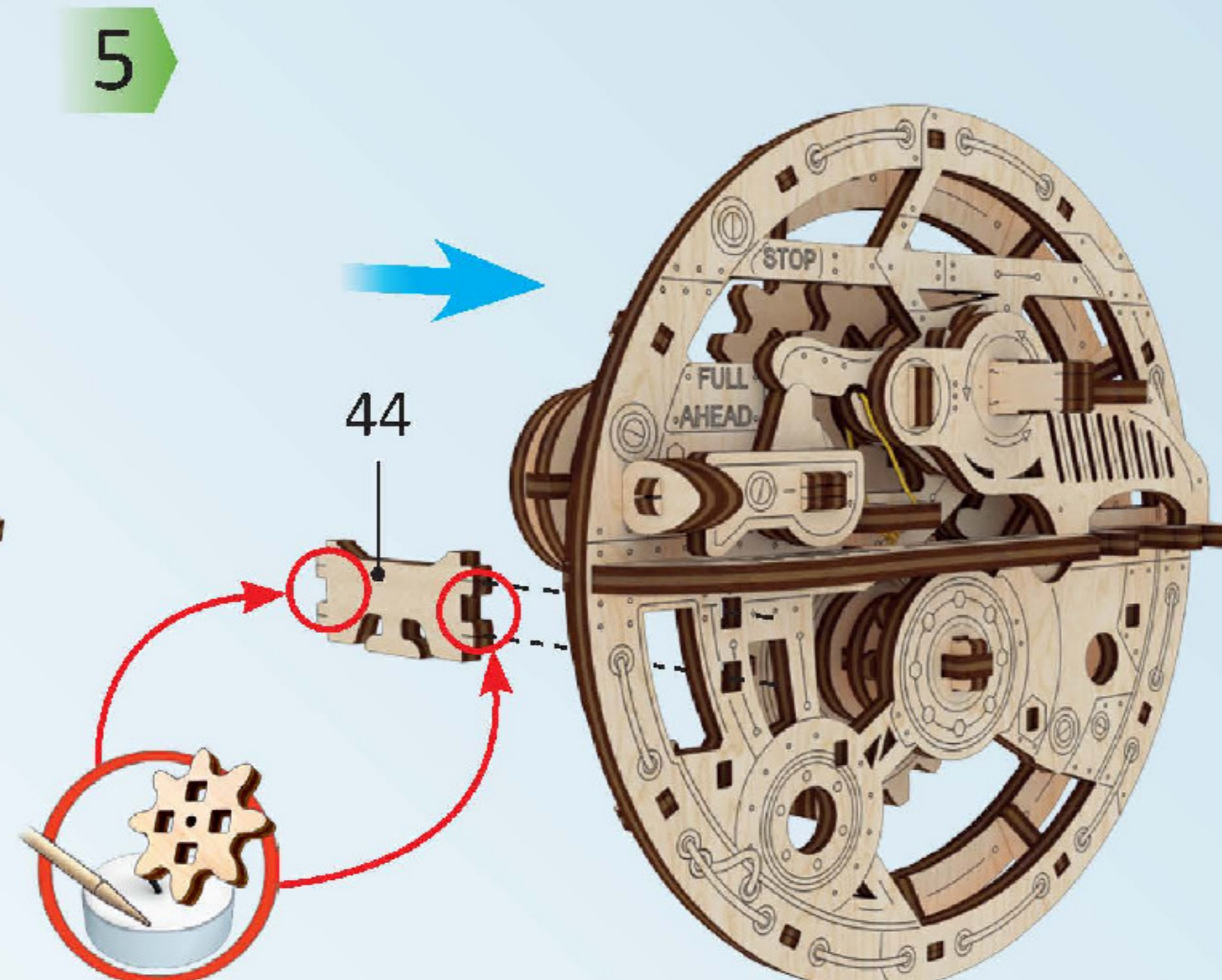
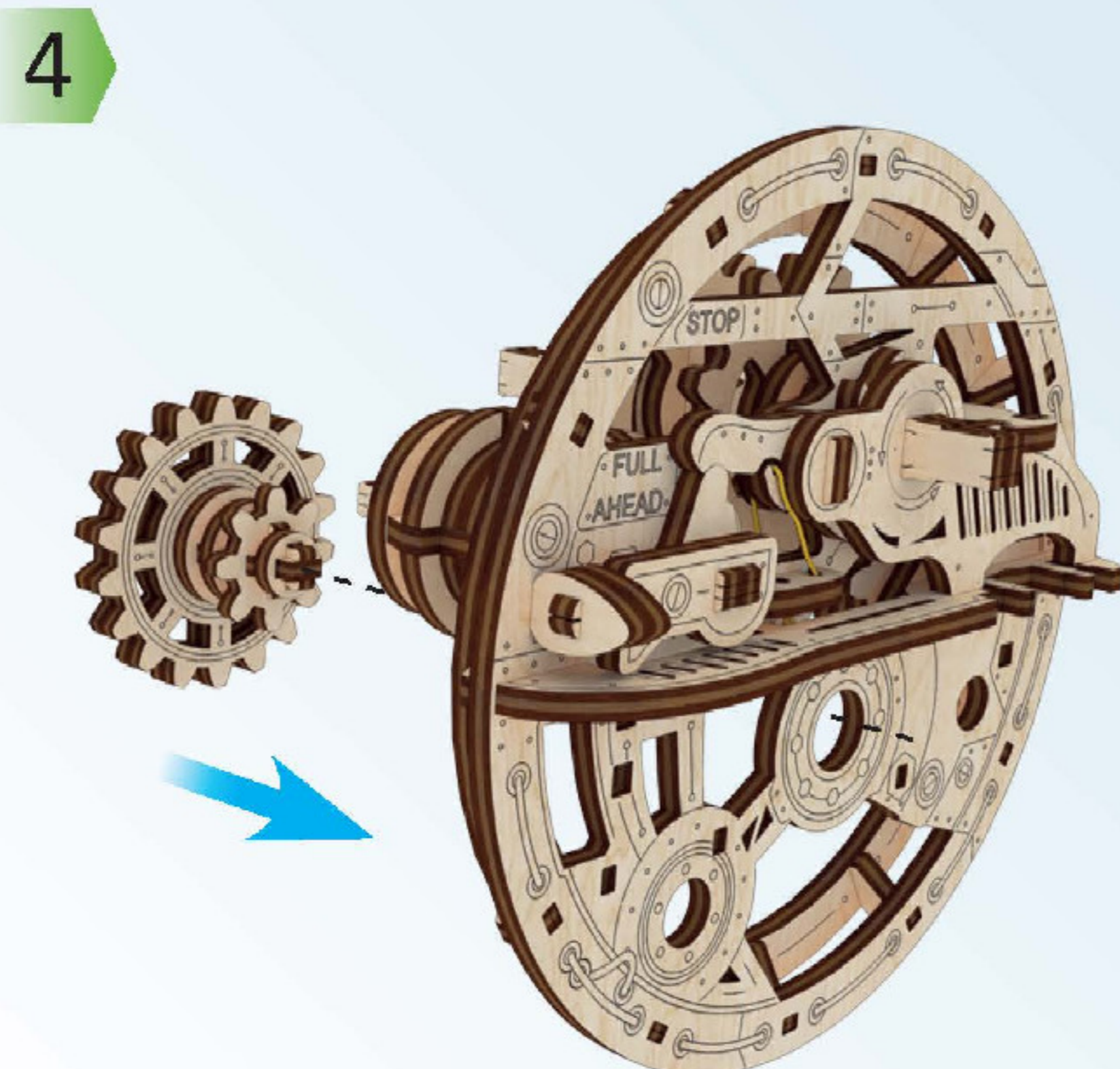
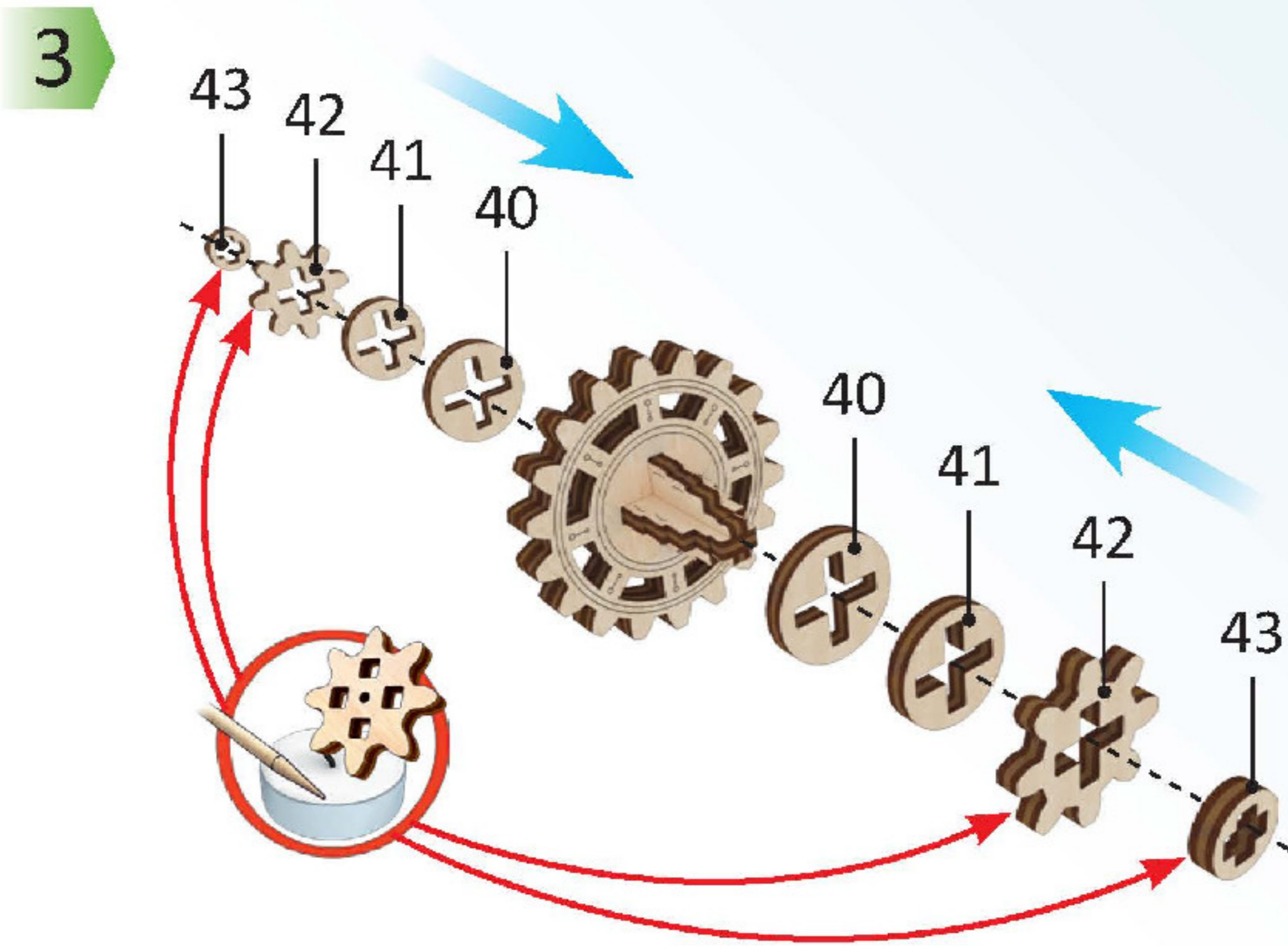

3

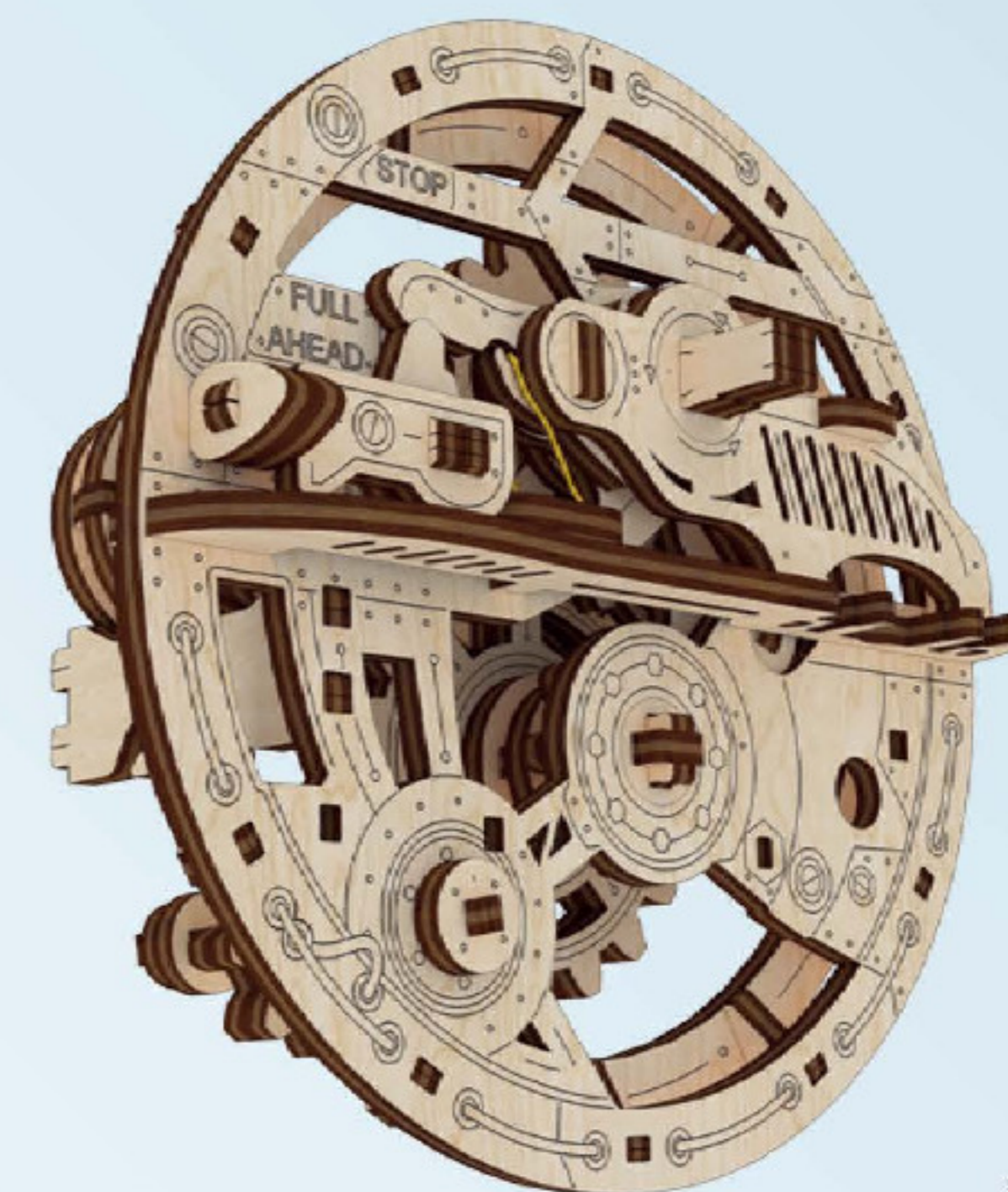
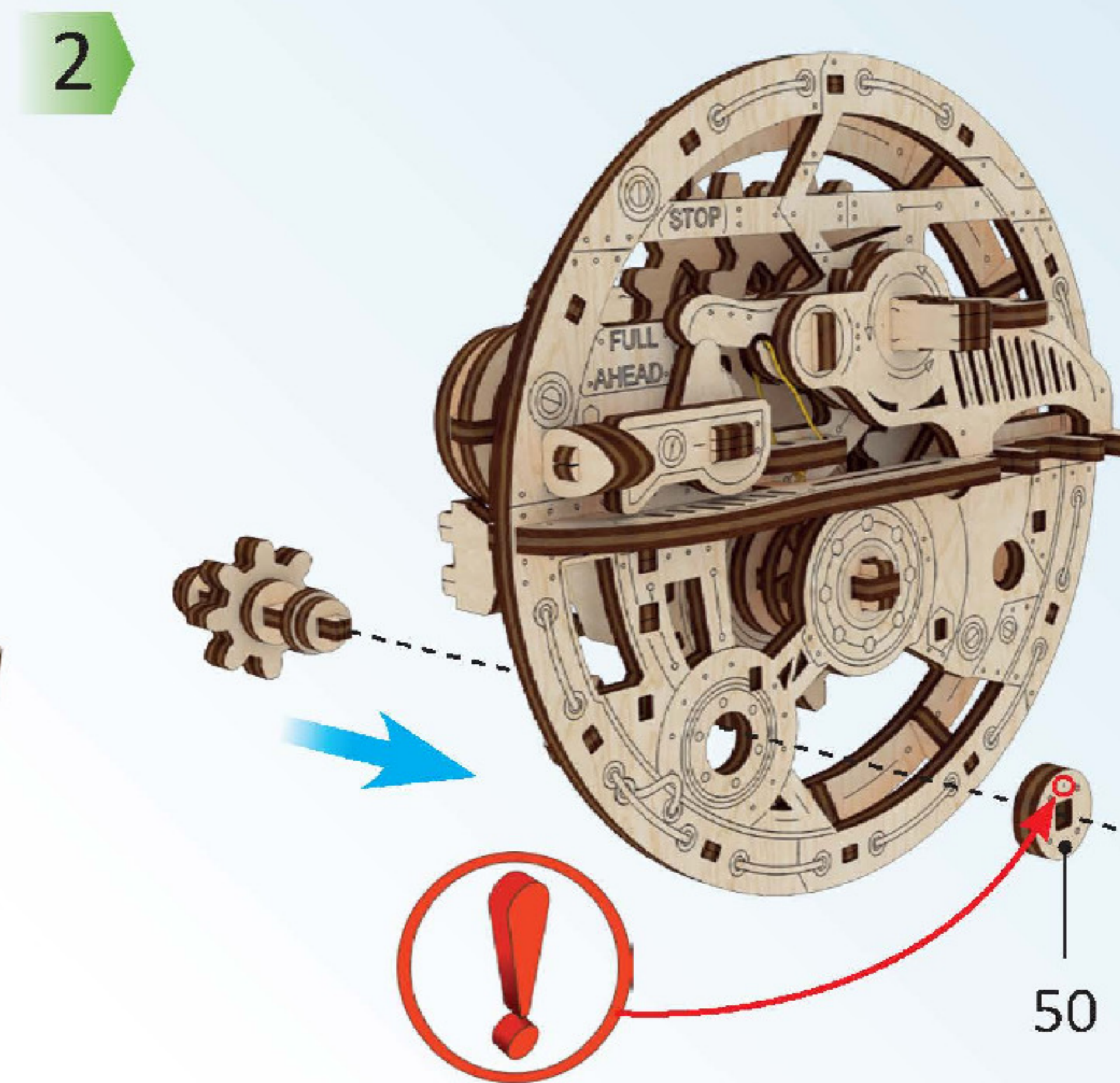
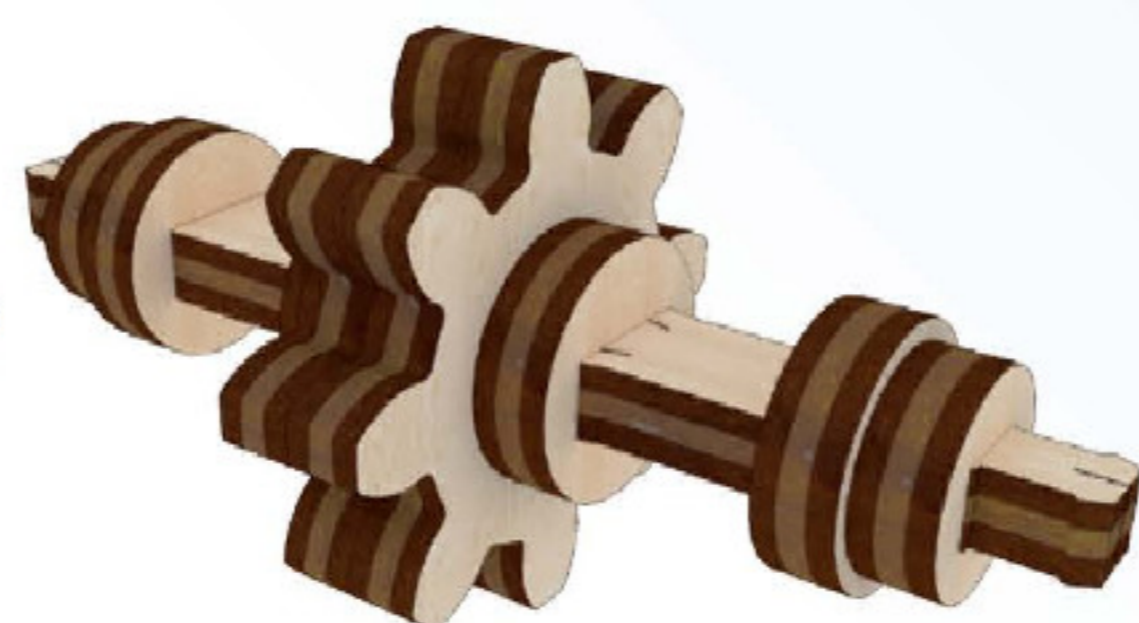
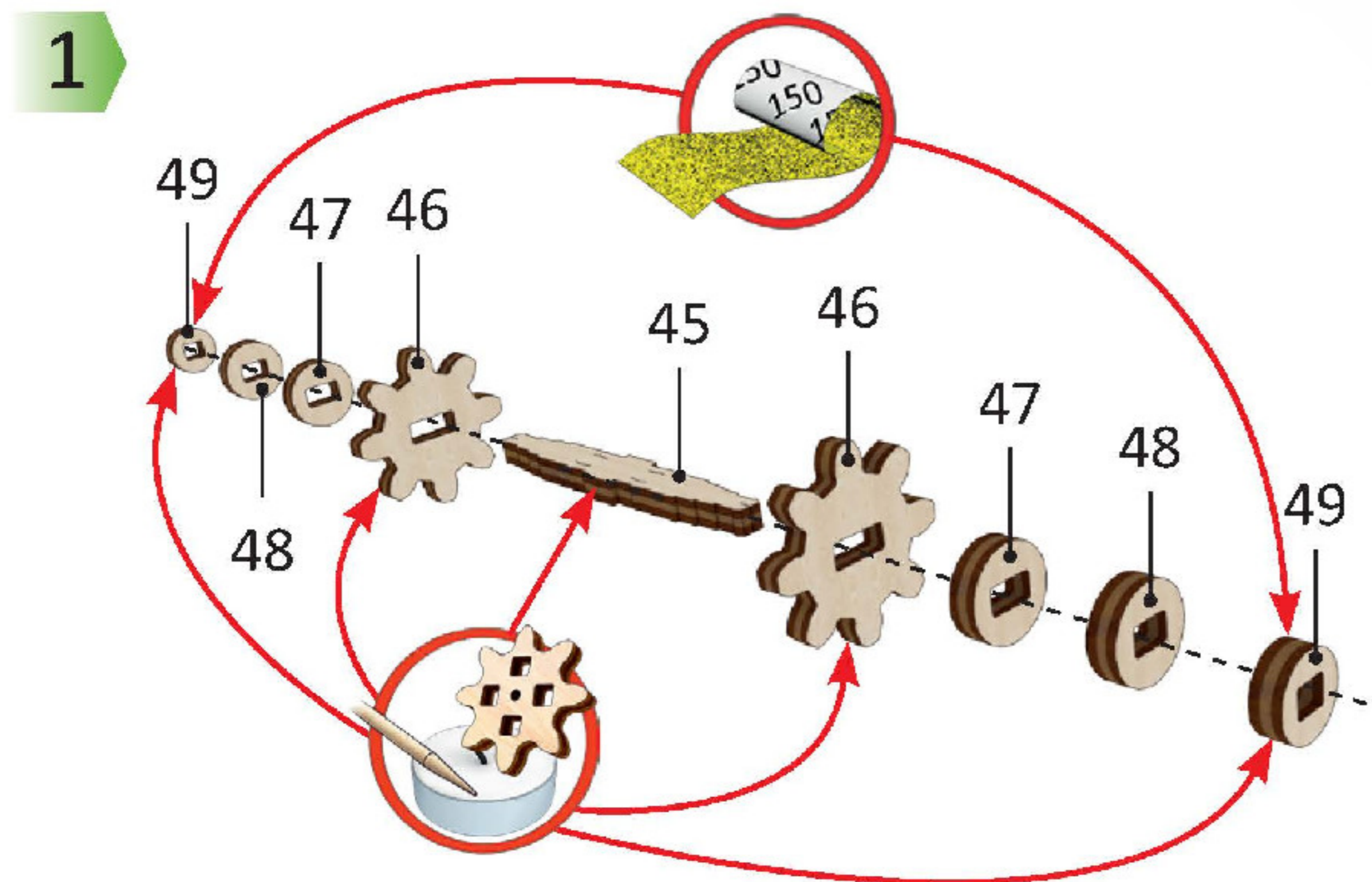

9

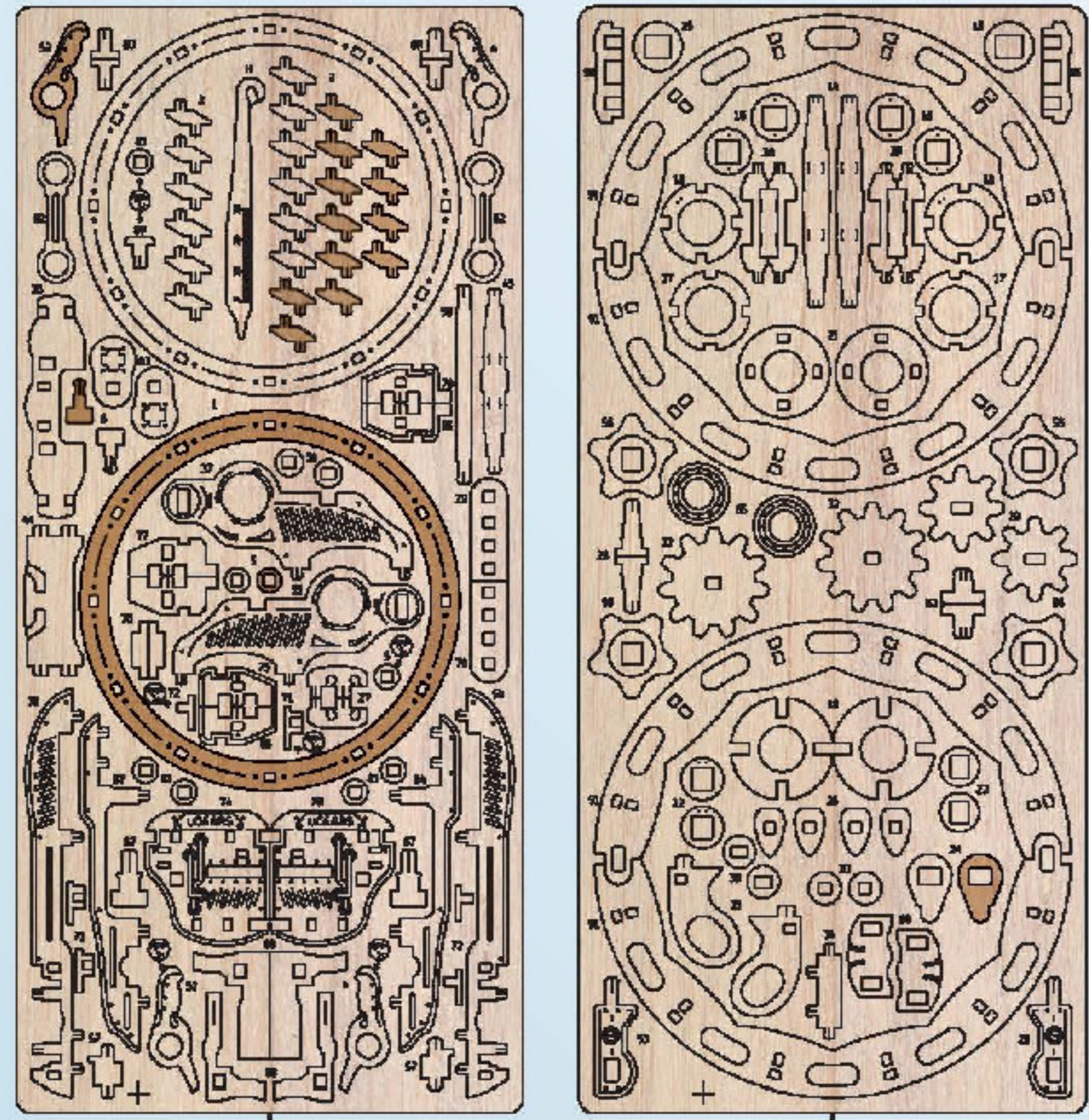

1

2

1

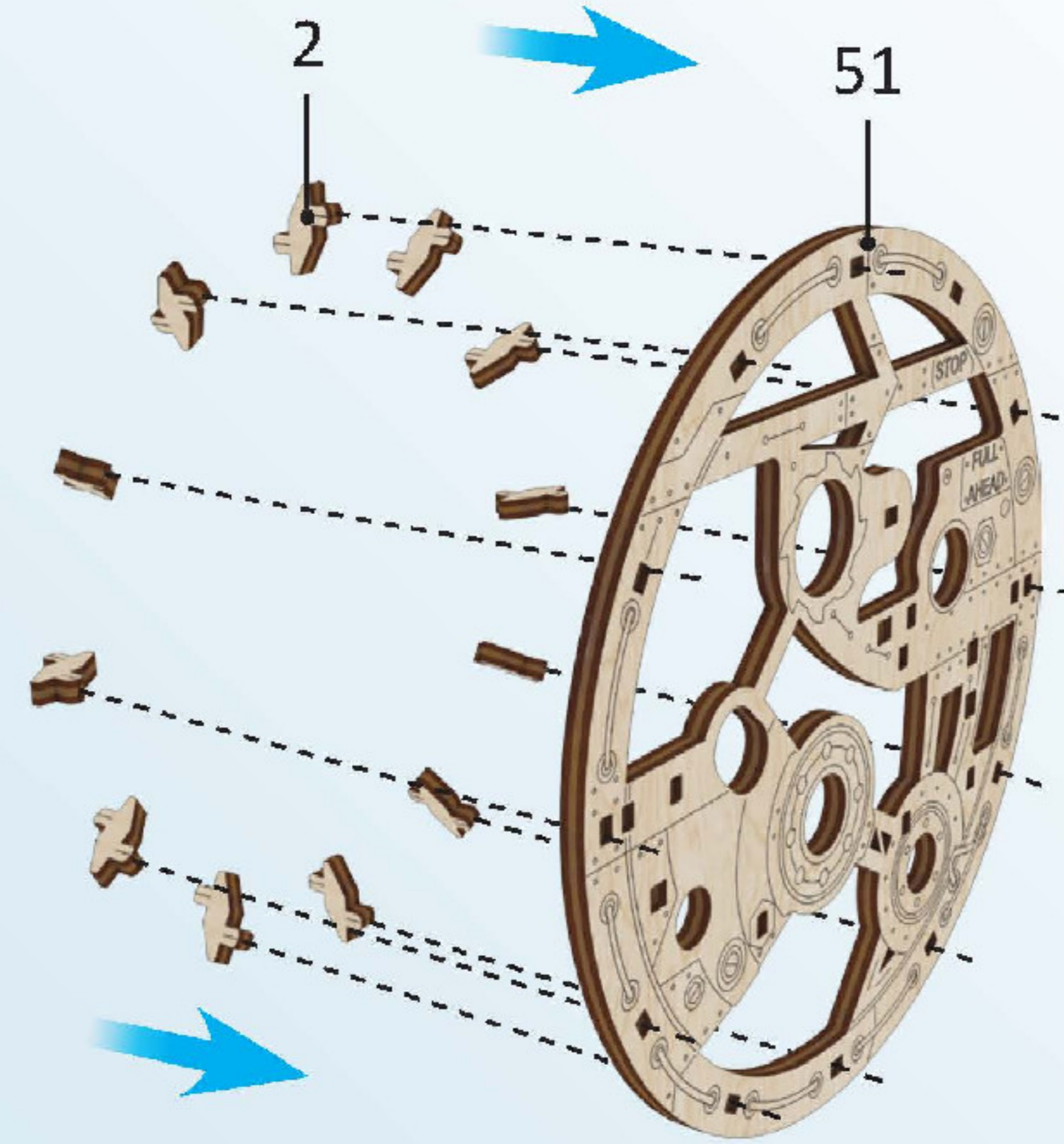

2

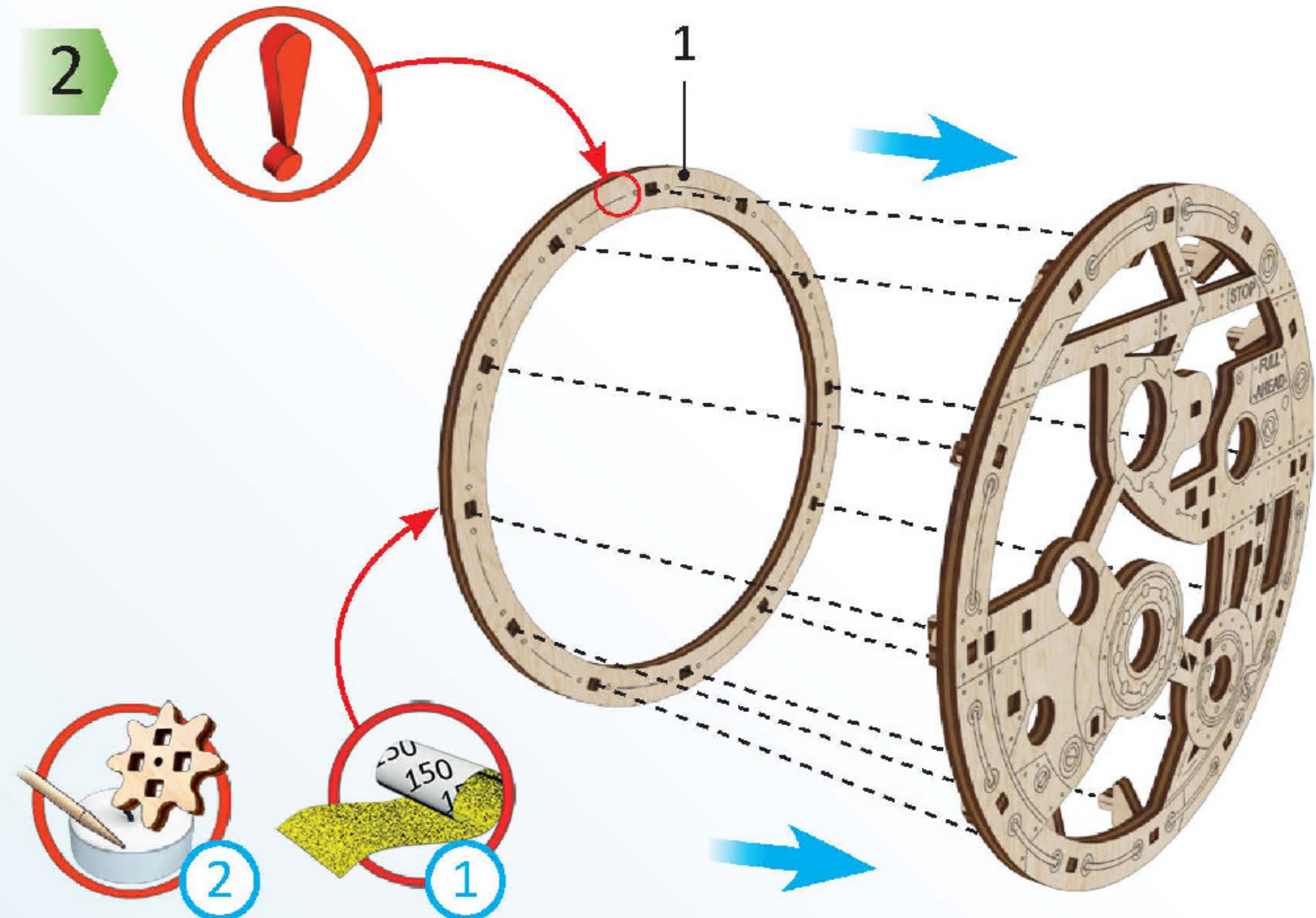

3

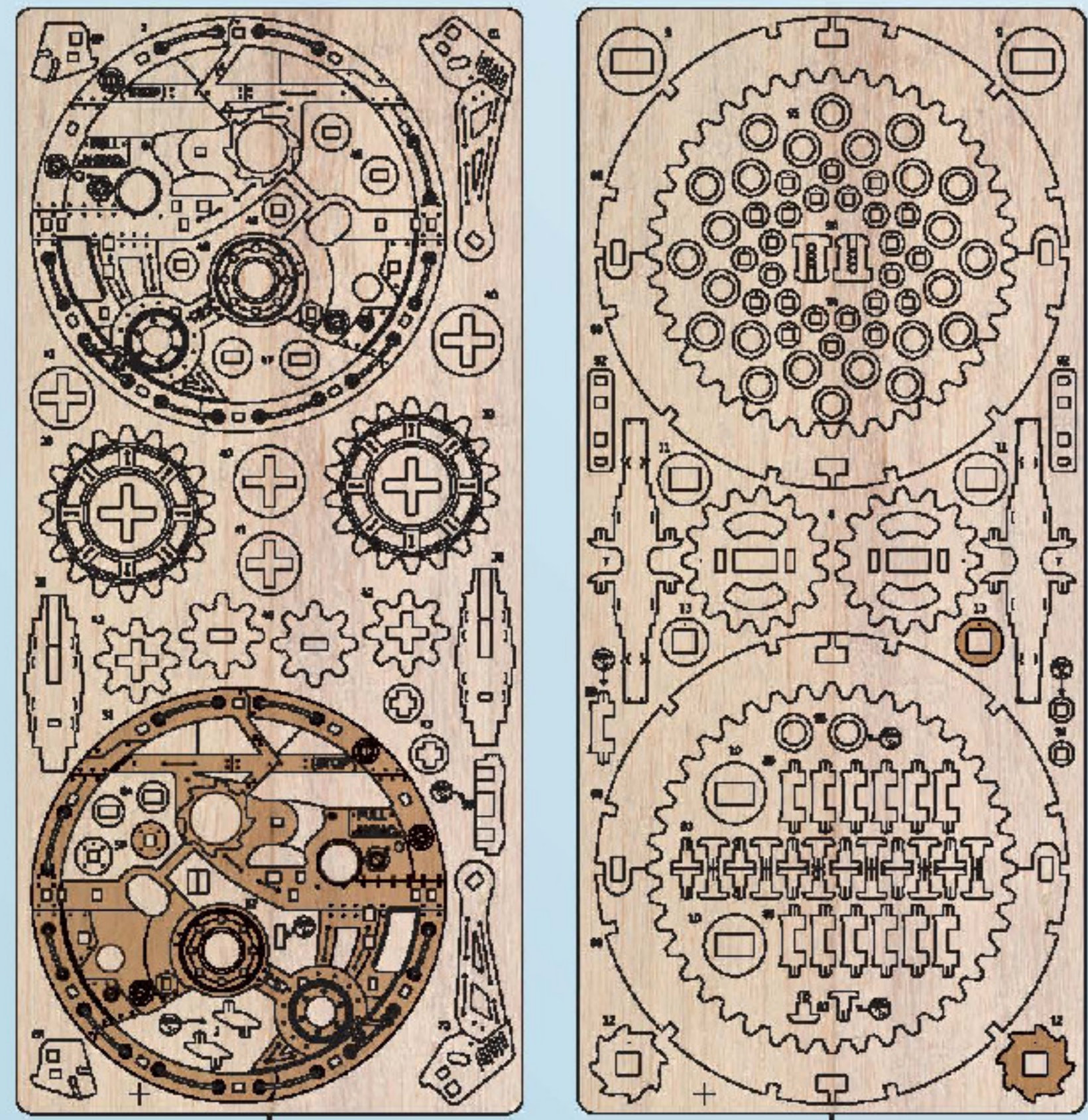
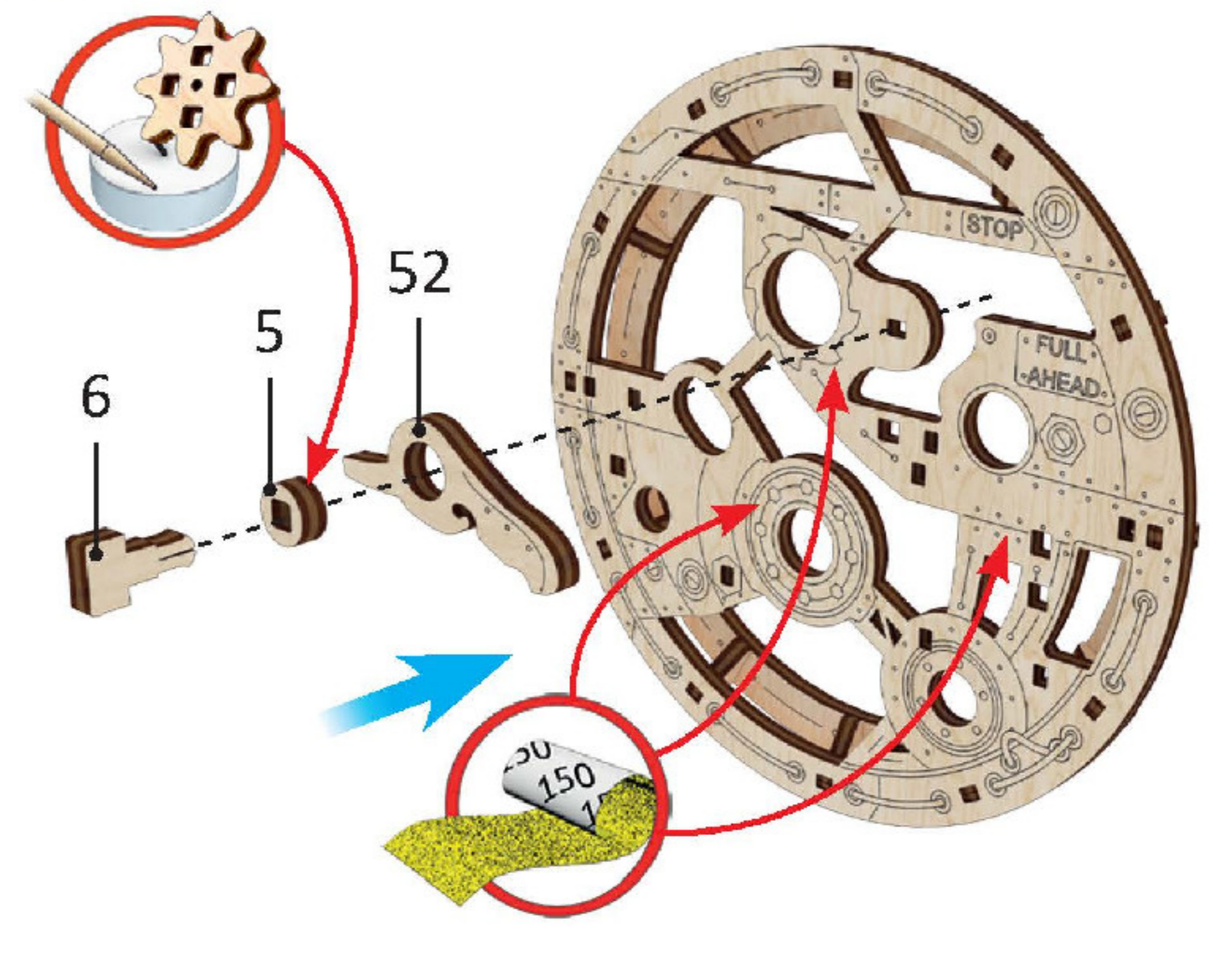

3

4

4

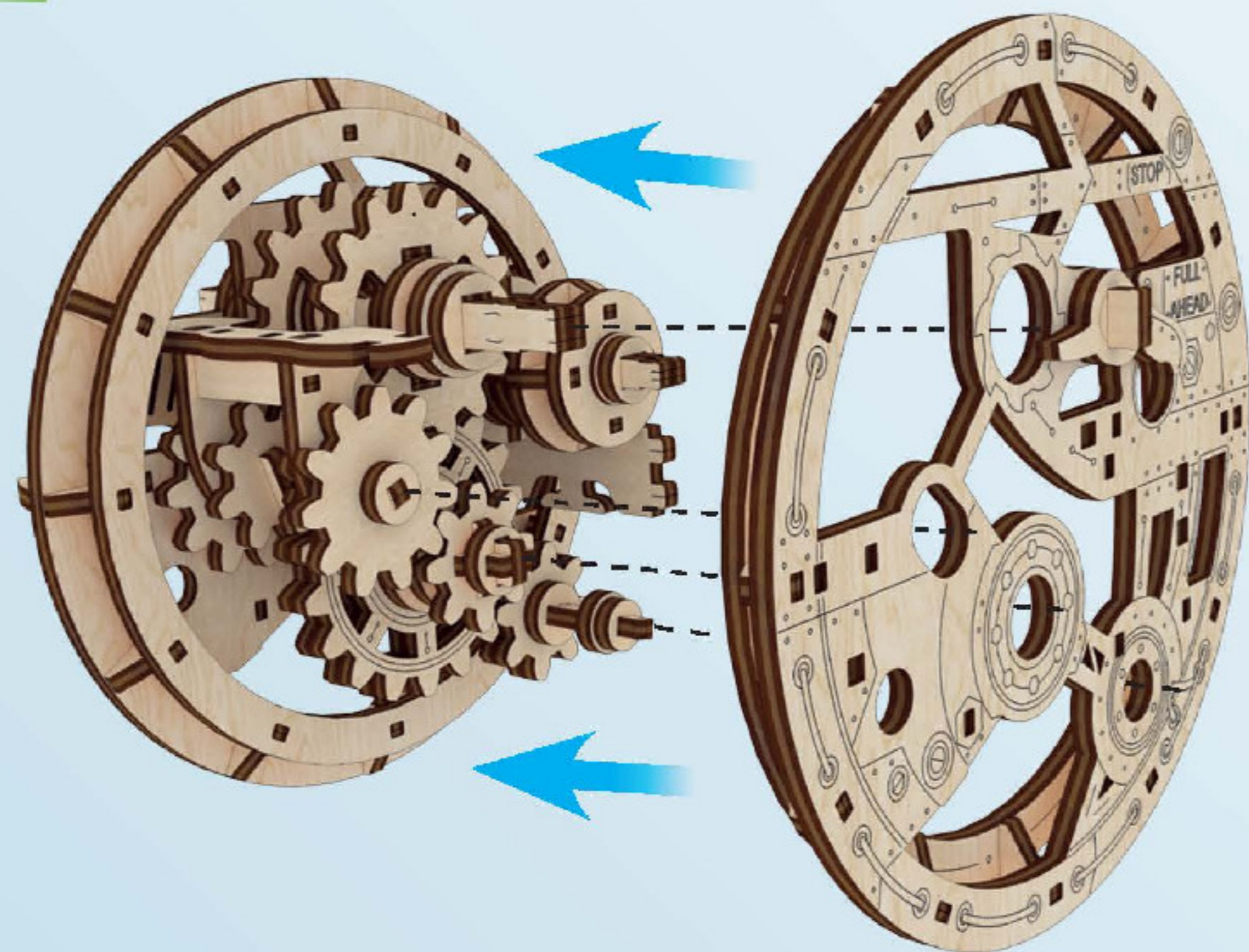

5

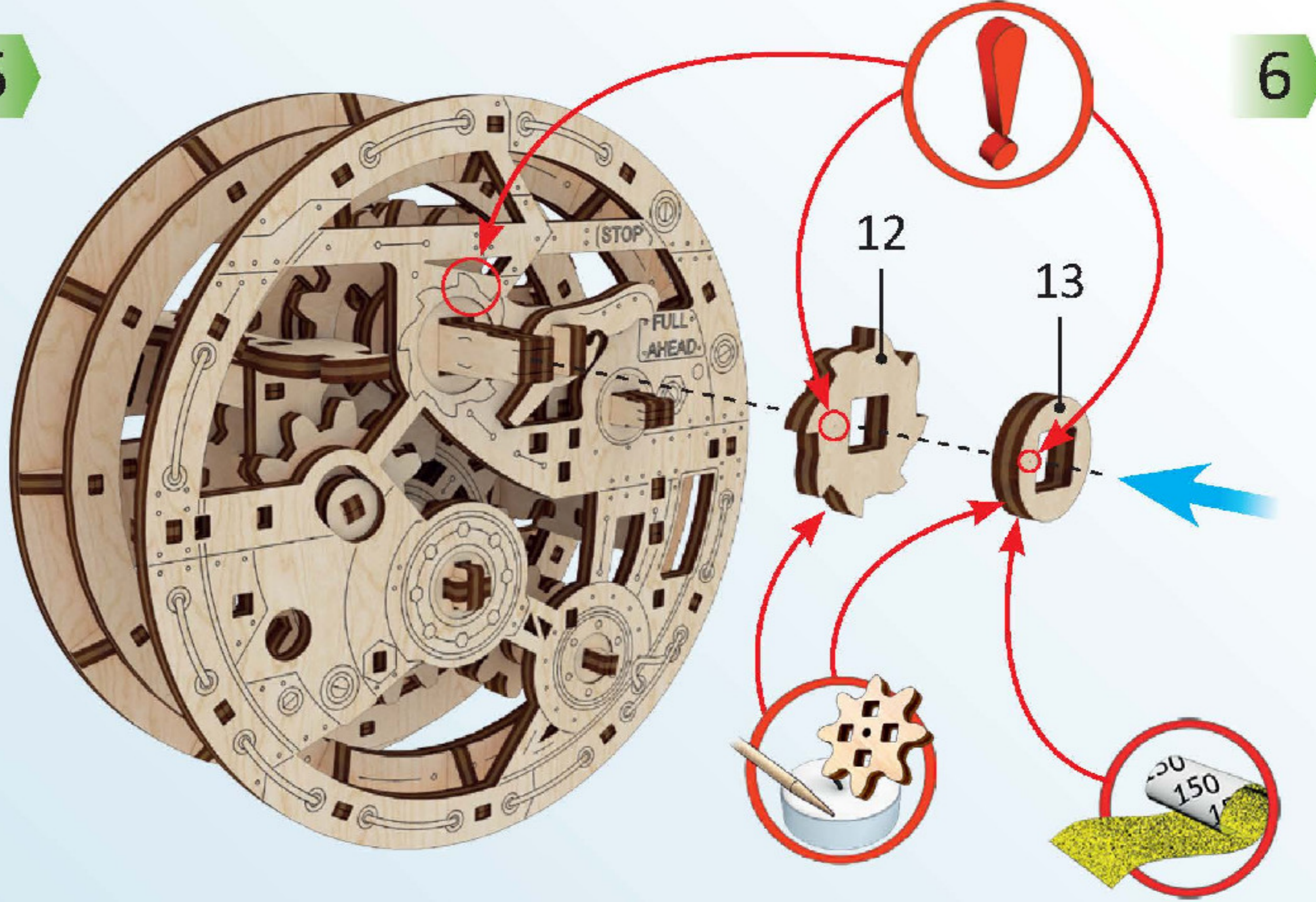

6

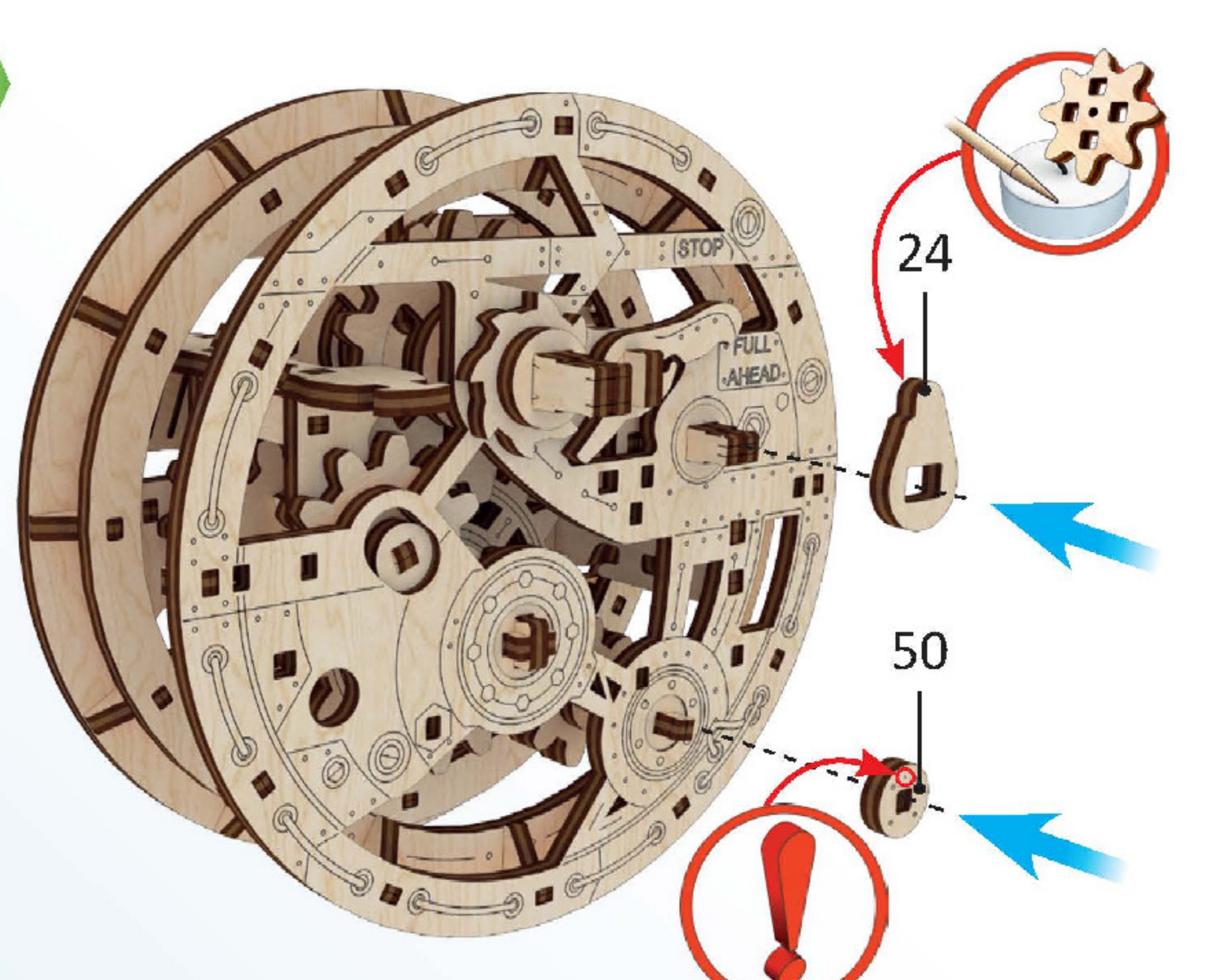

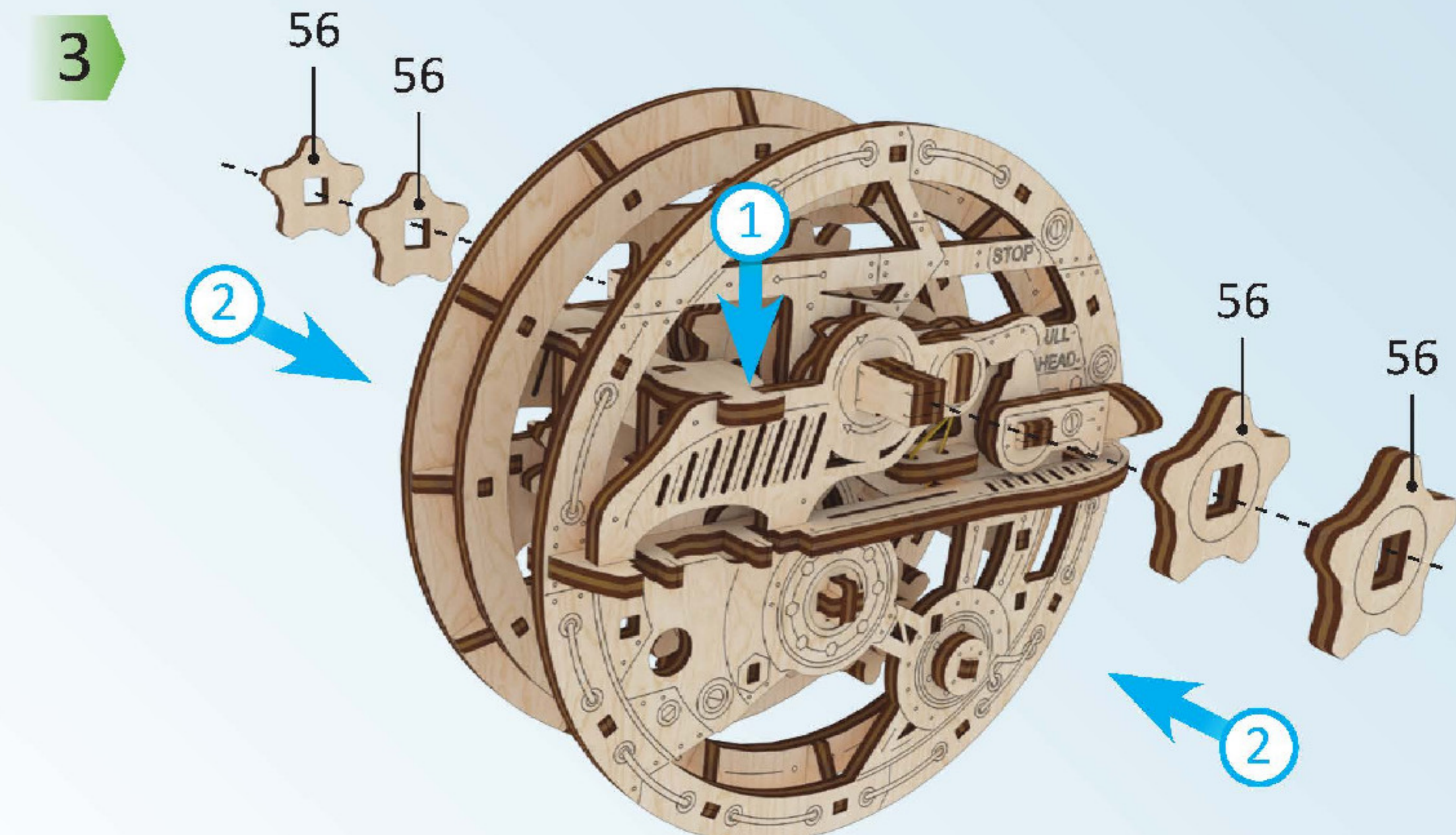
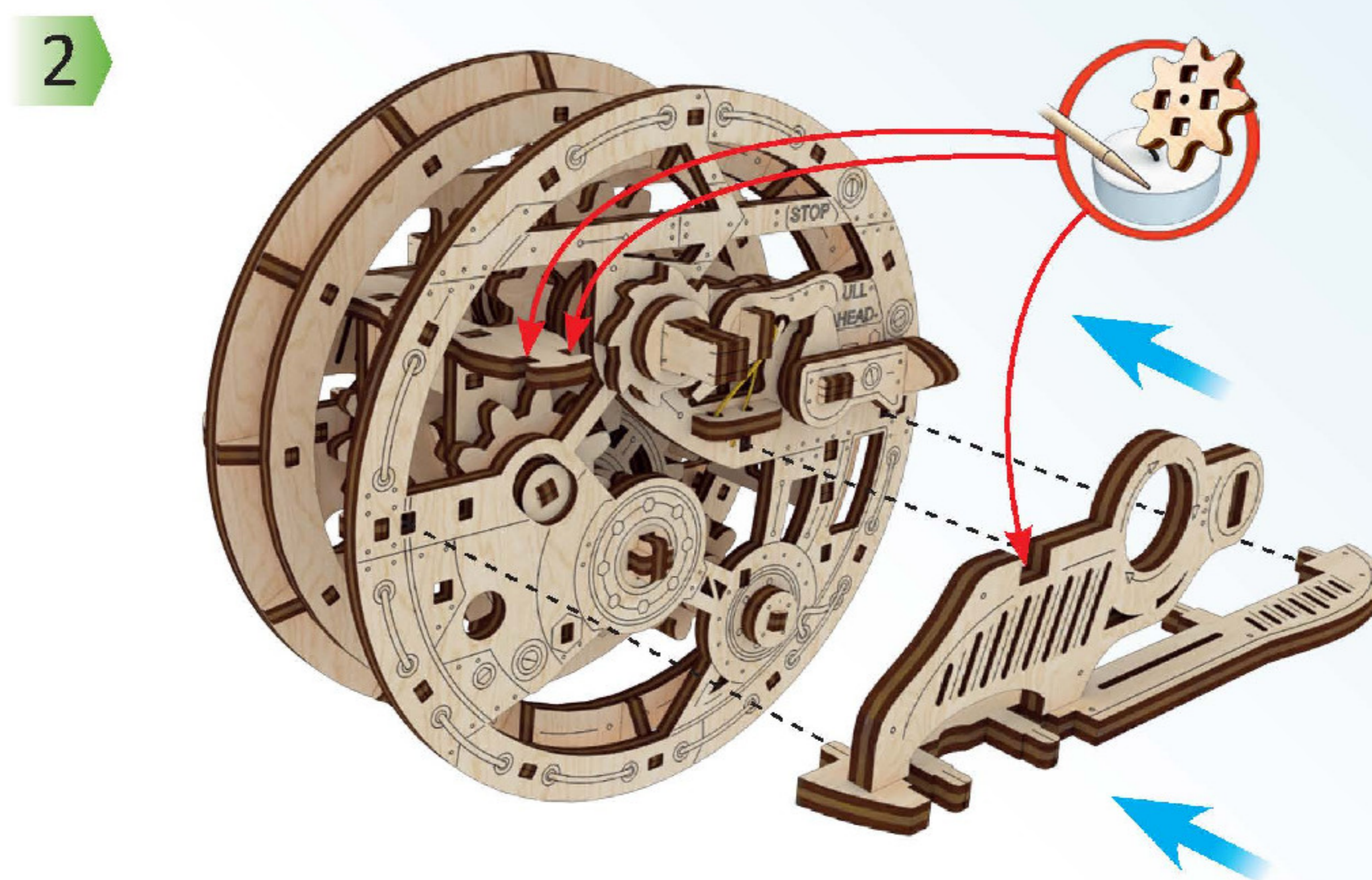
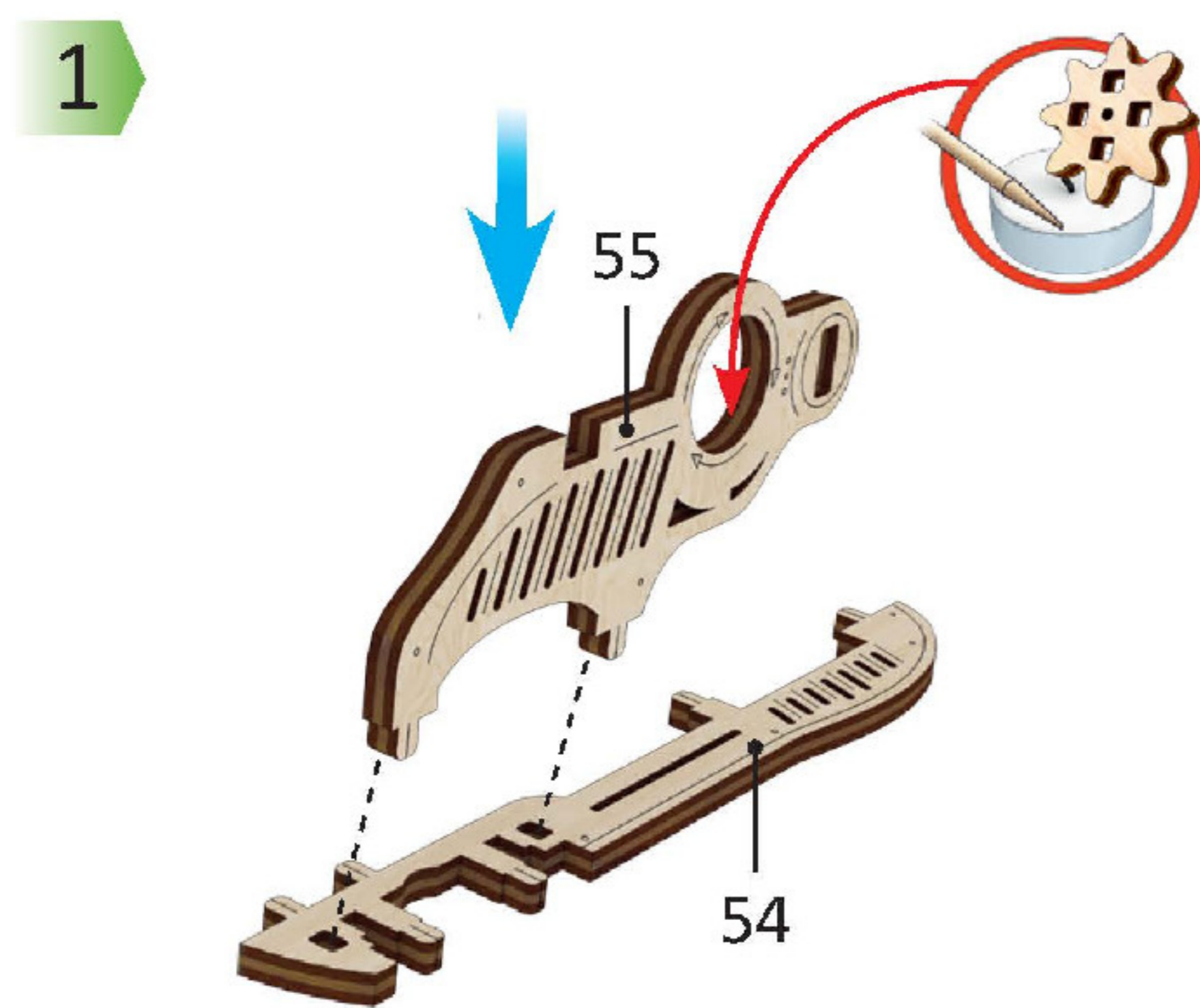
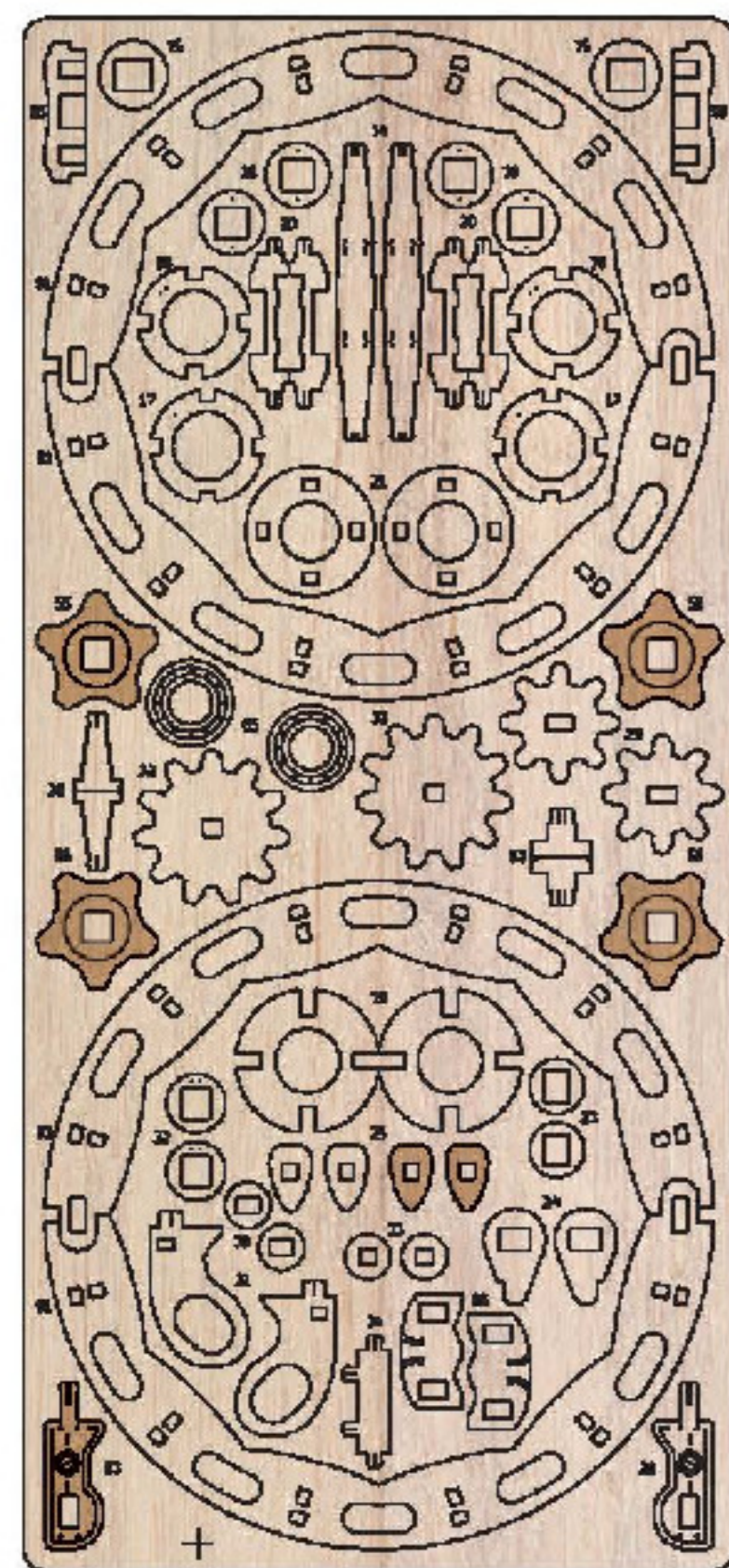
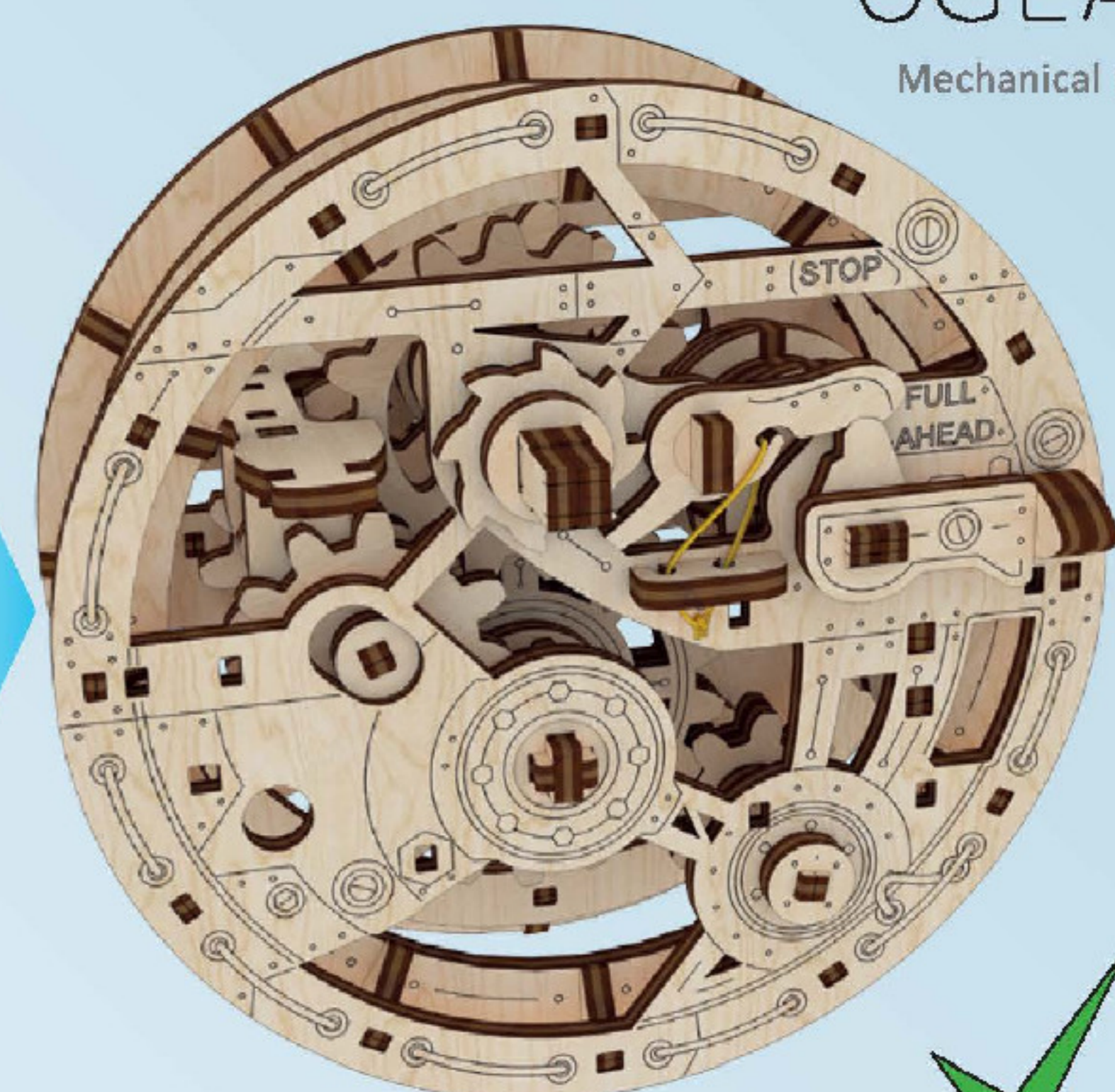
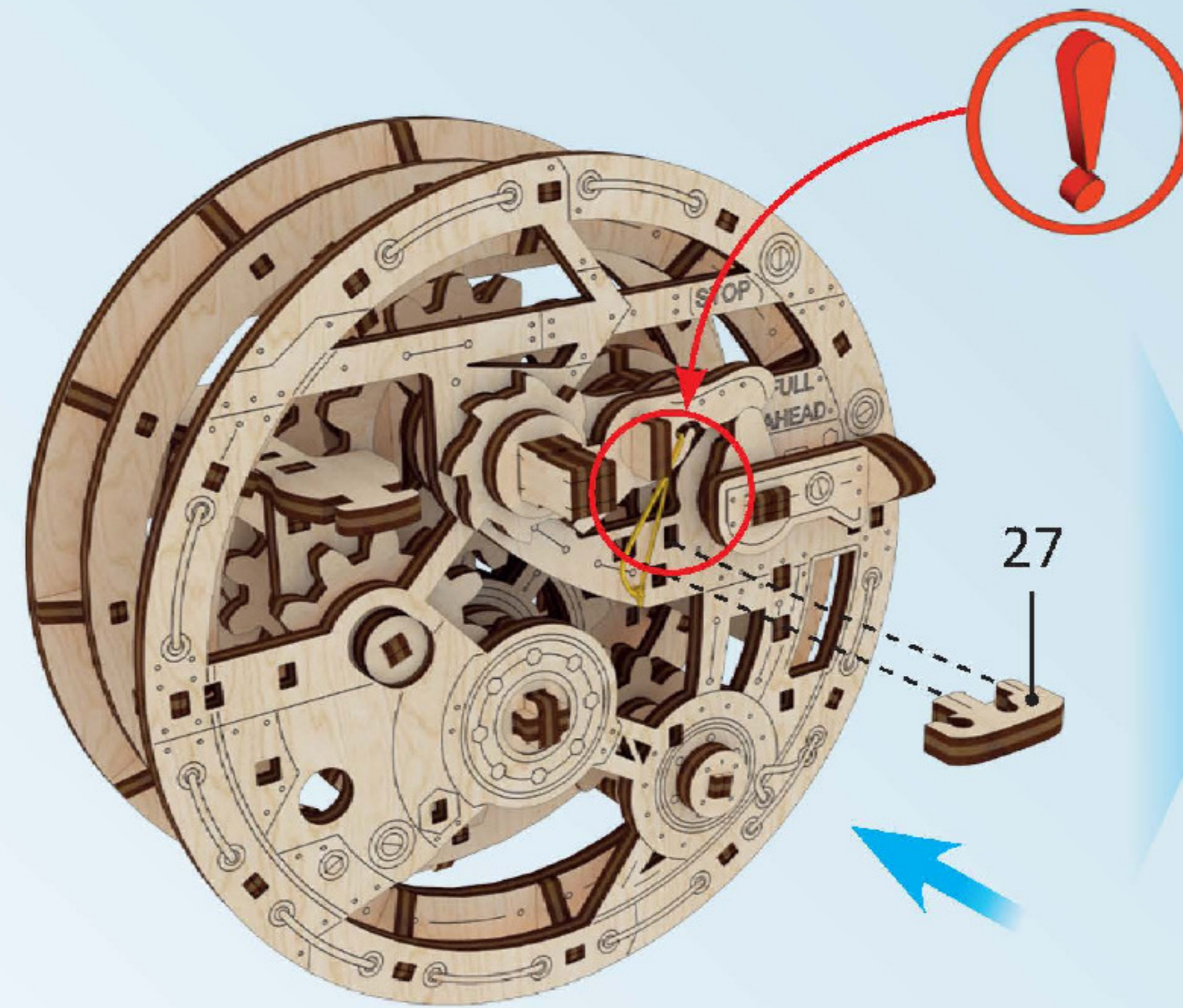
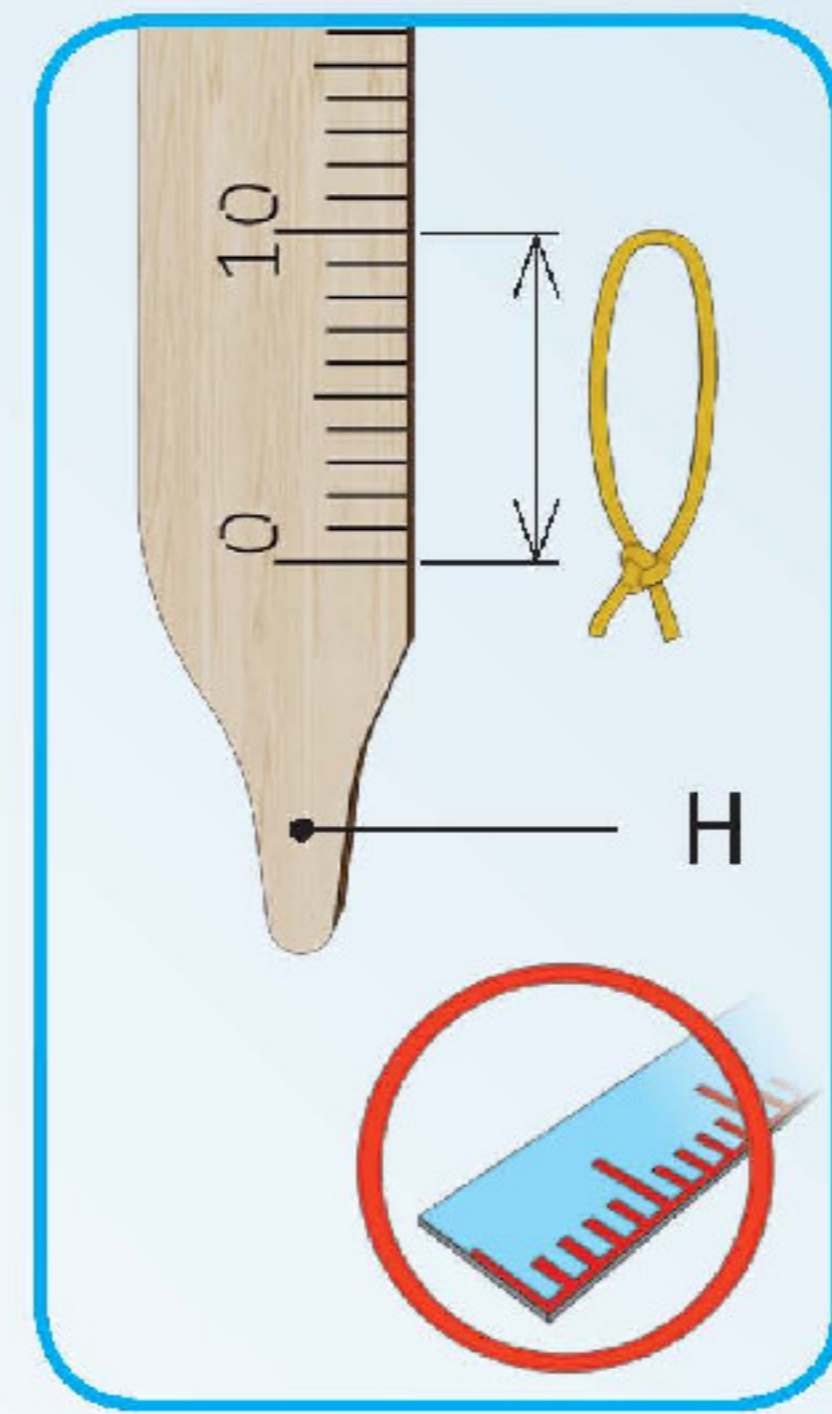
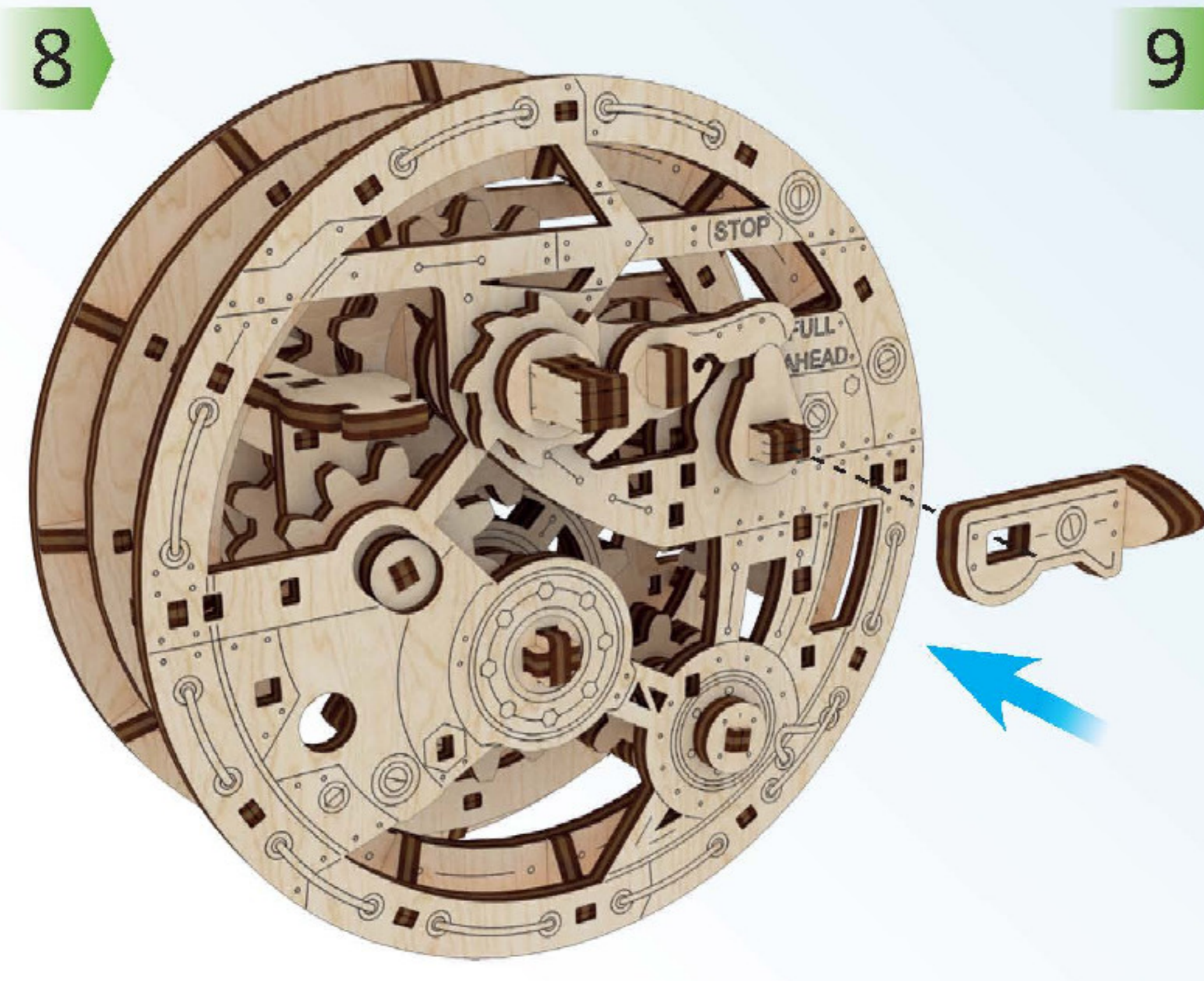
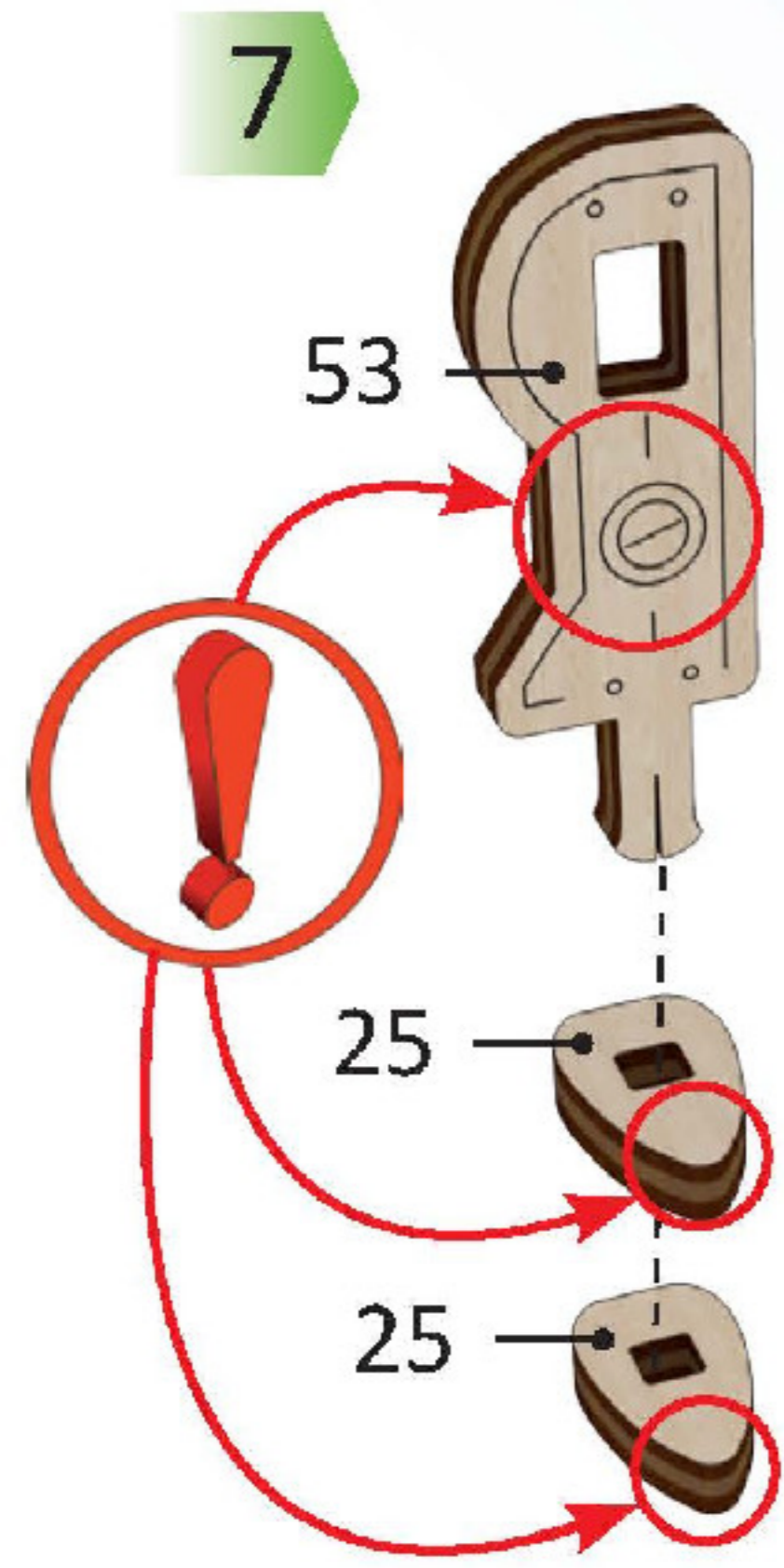
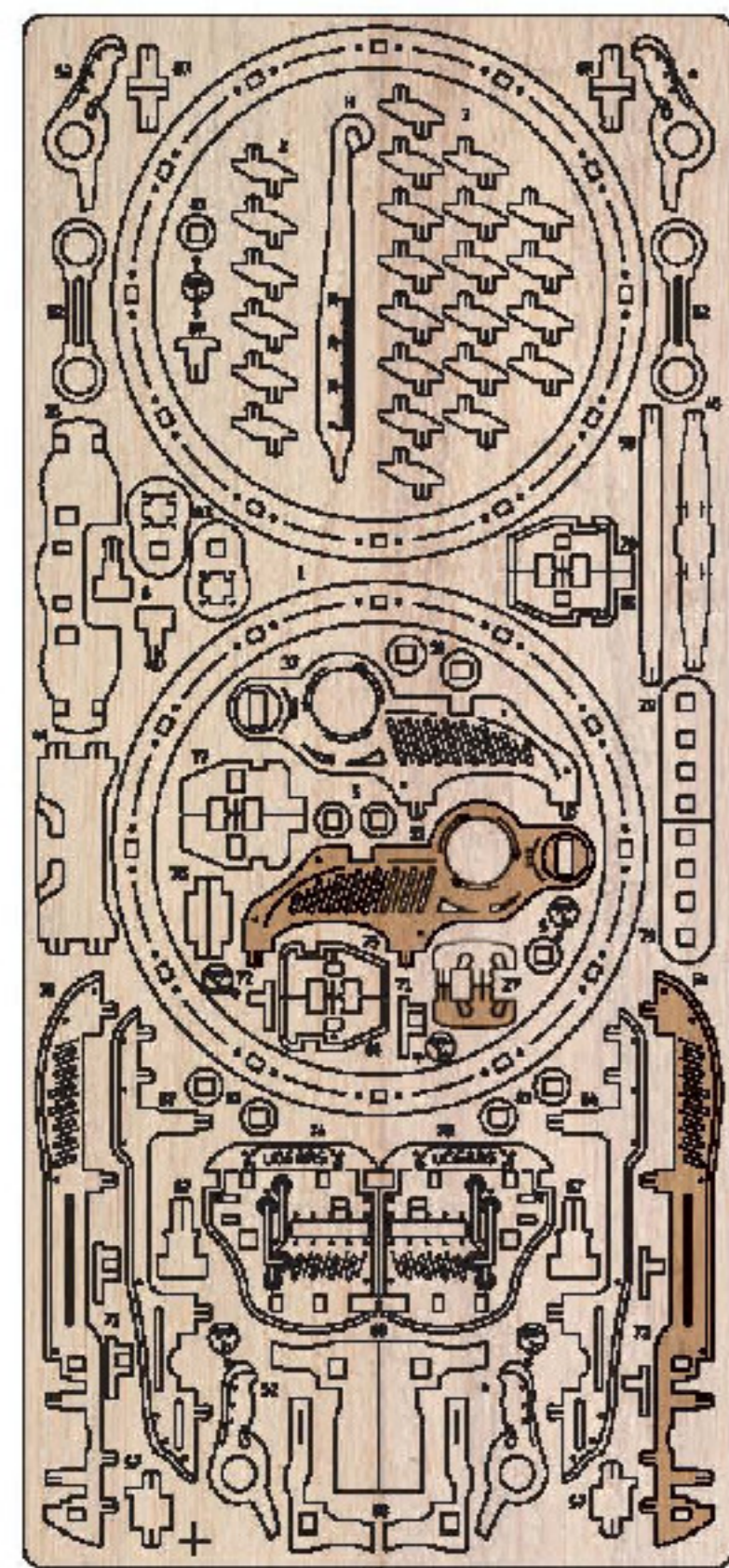

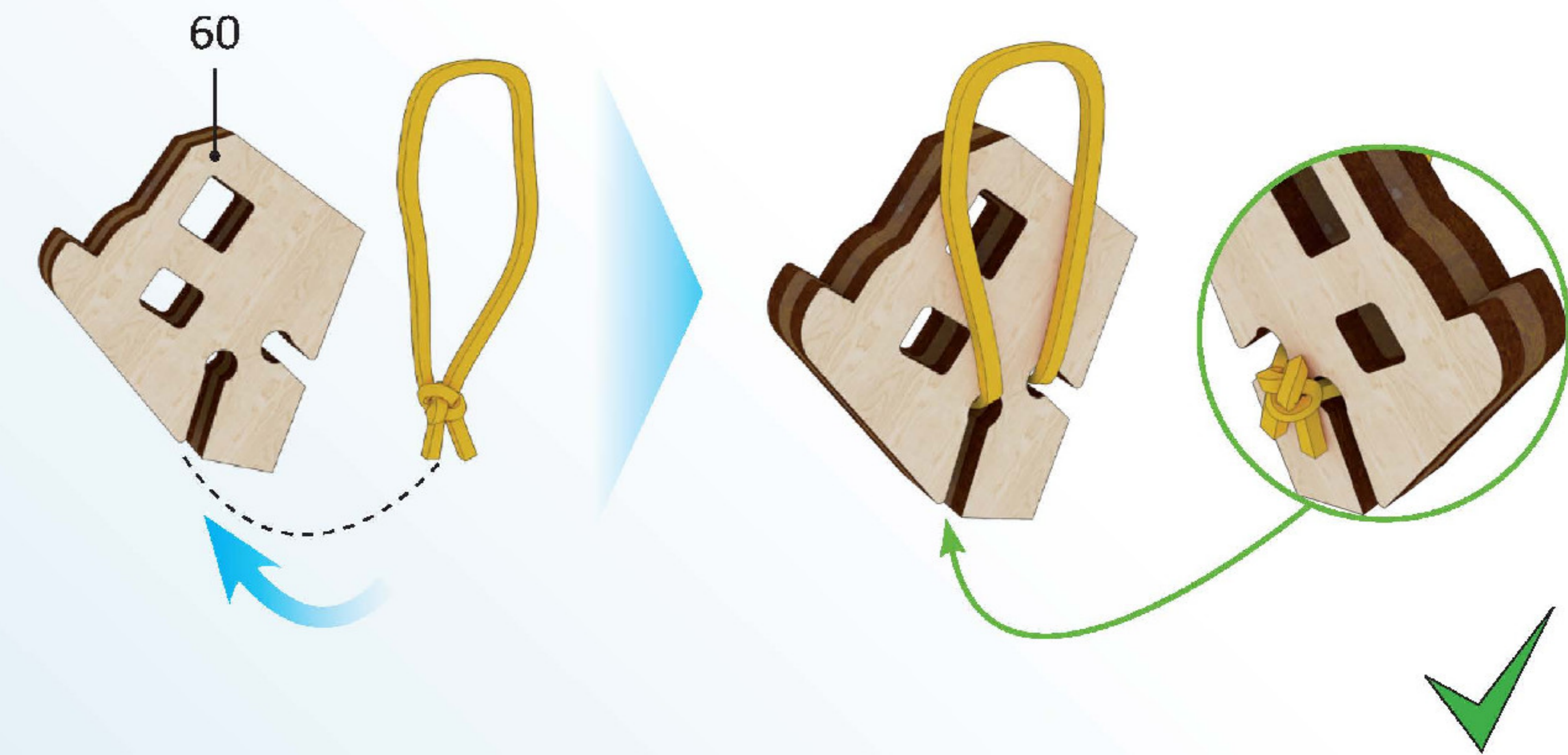
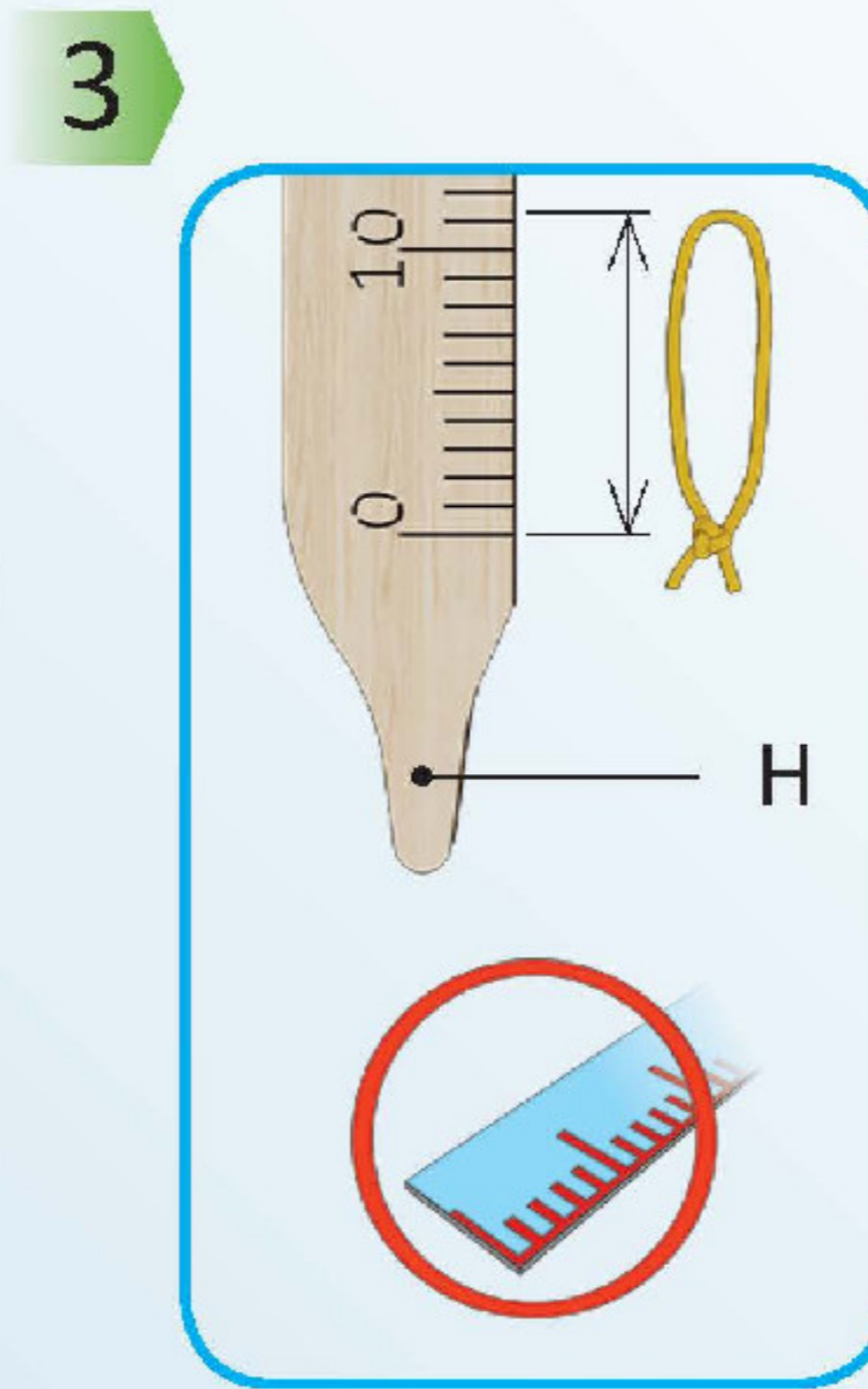
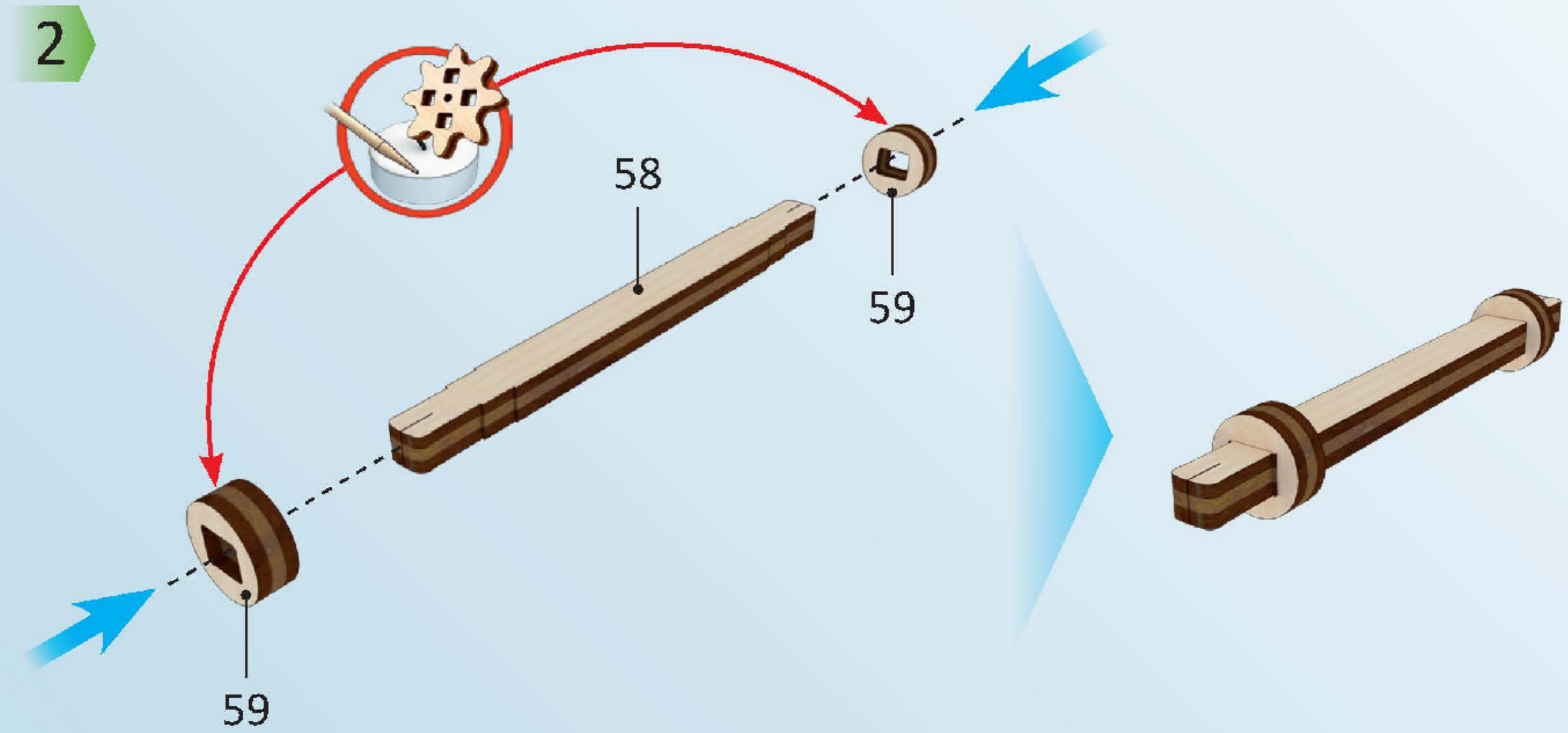
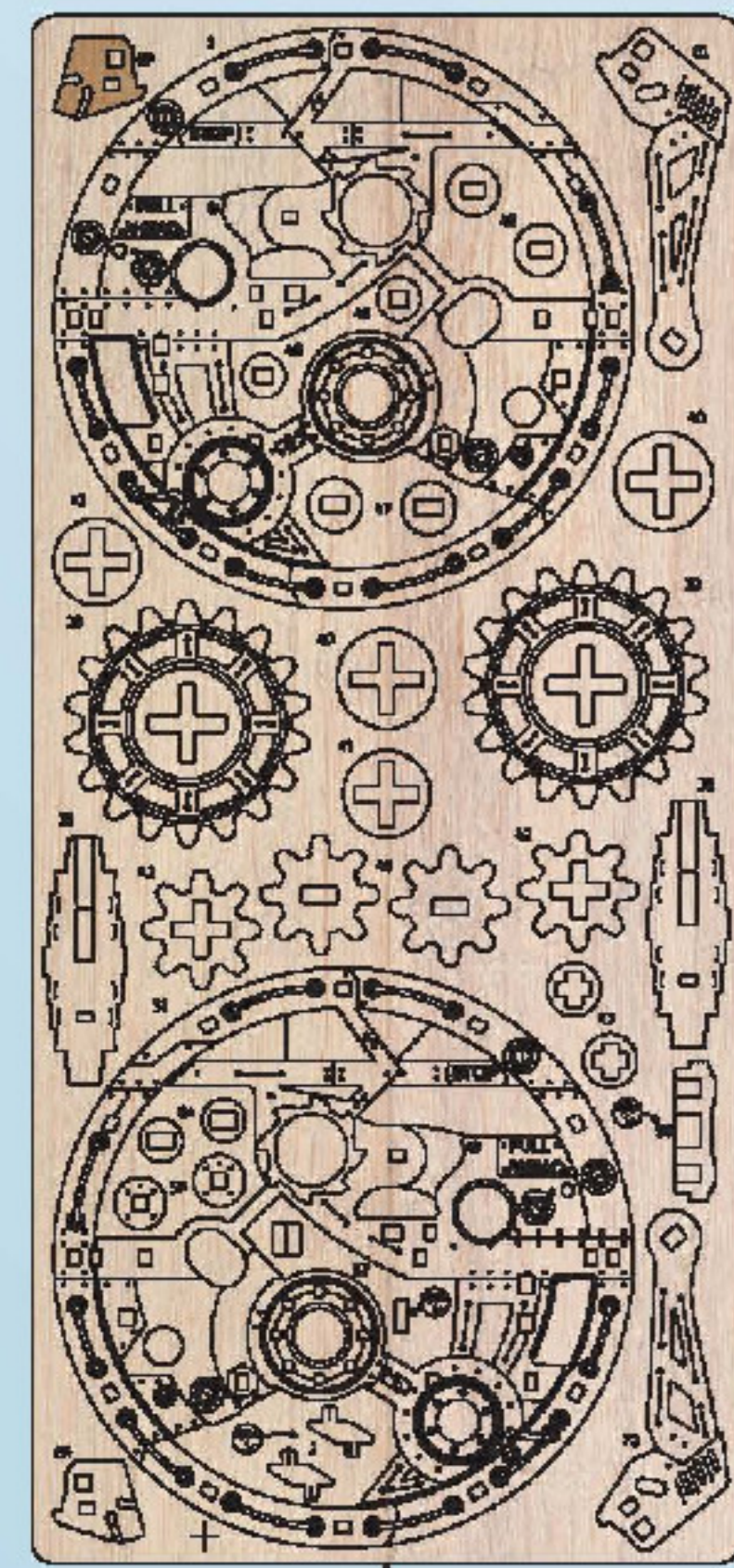
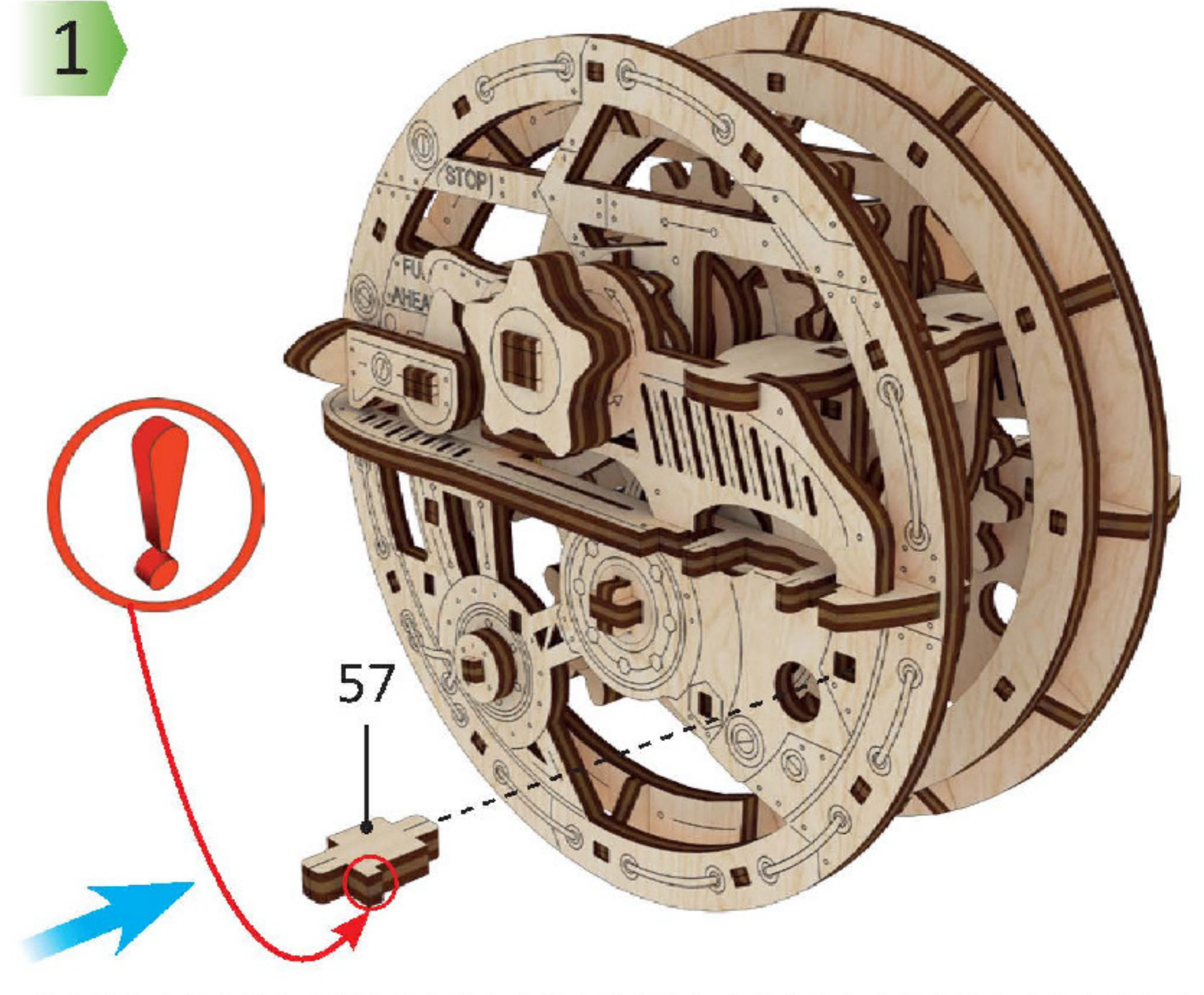
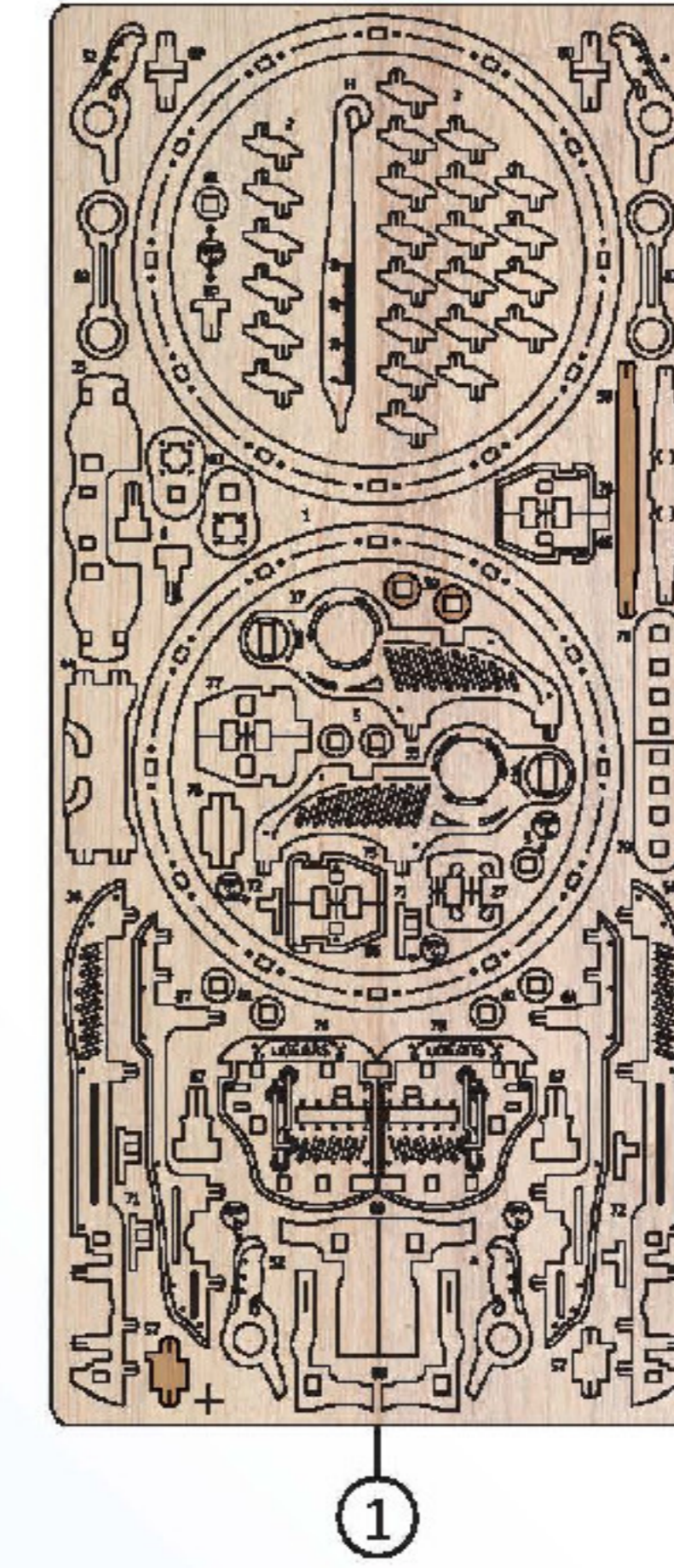
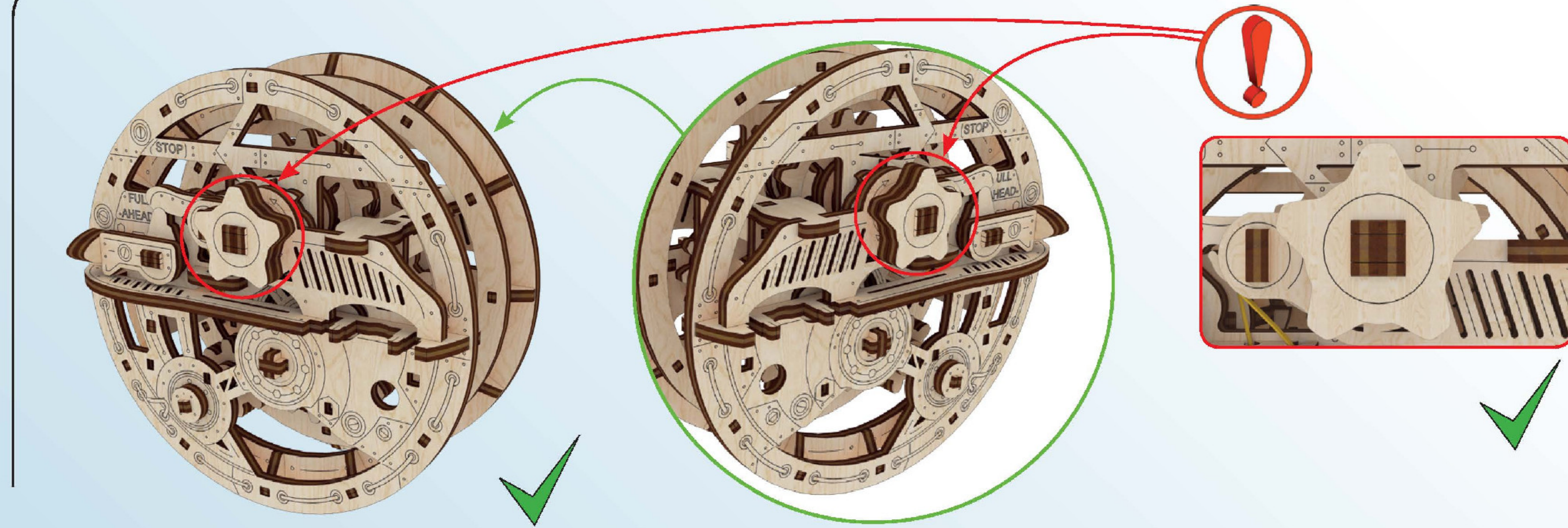

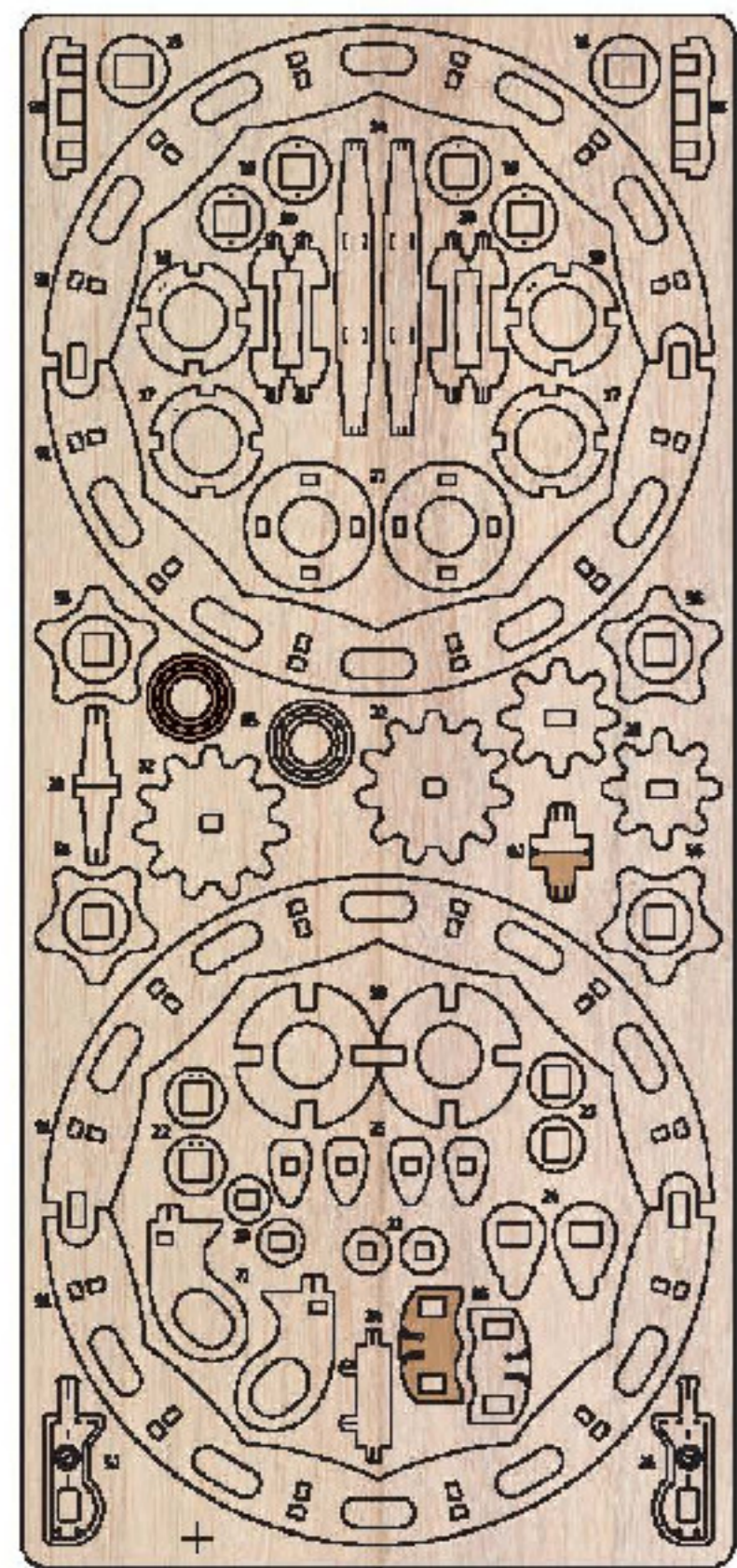

2

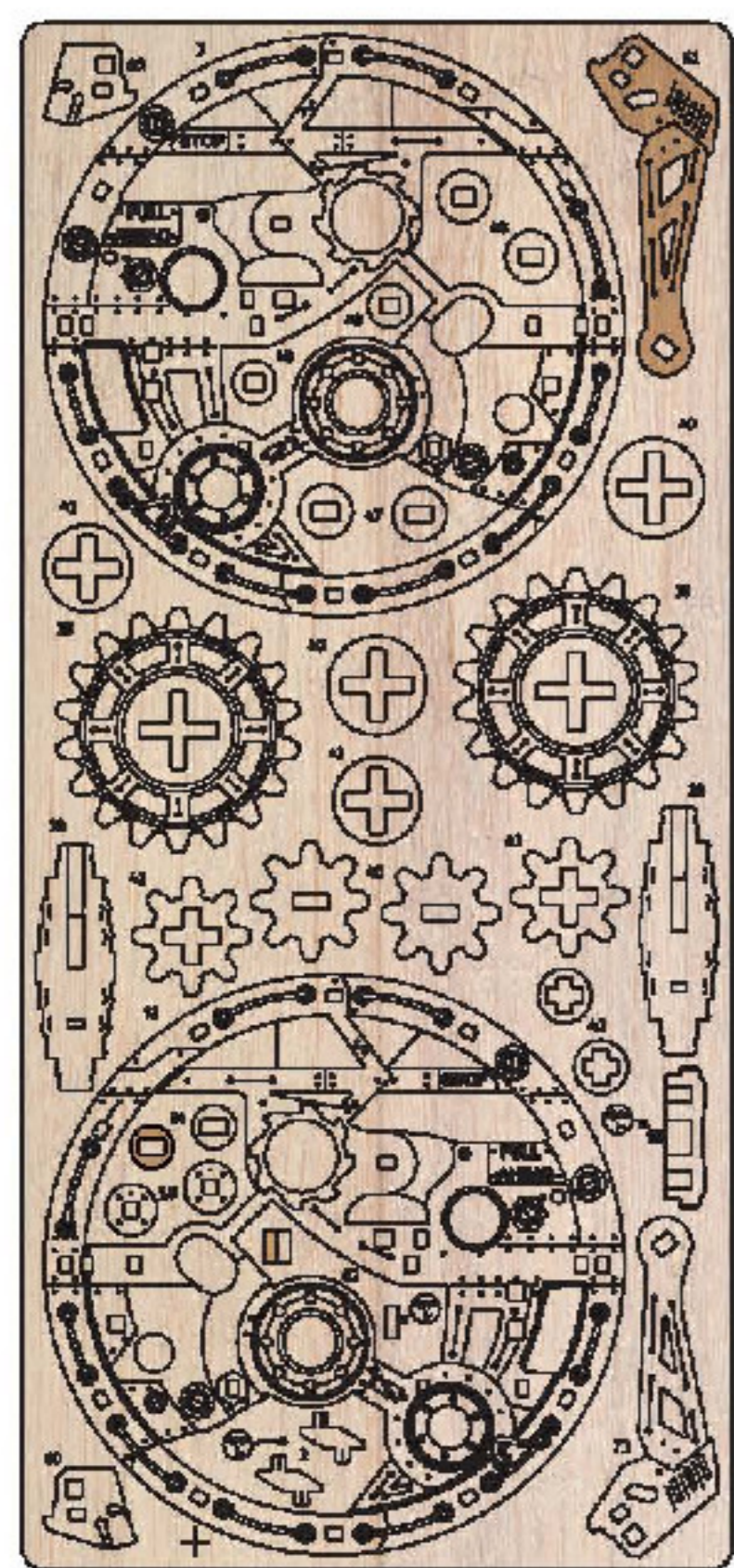
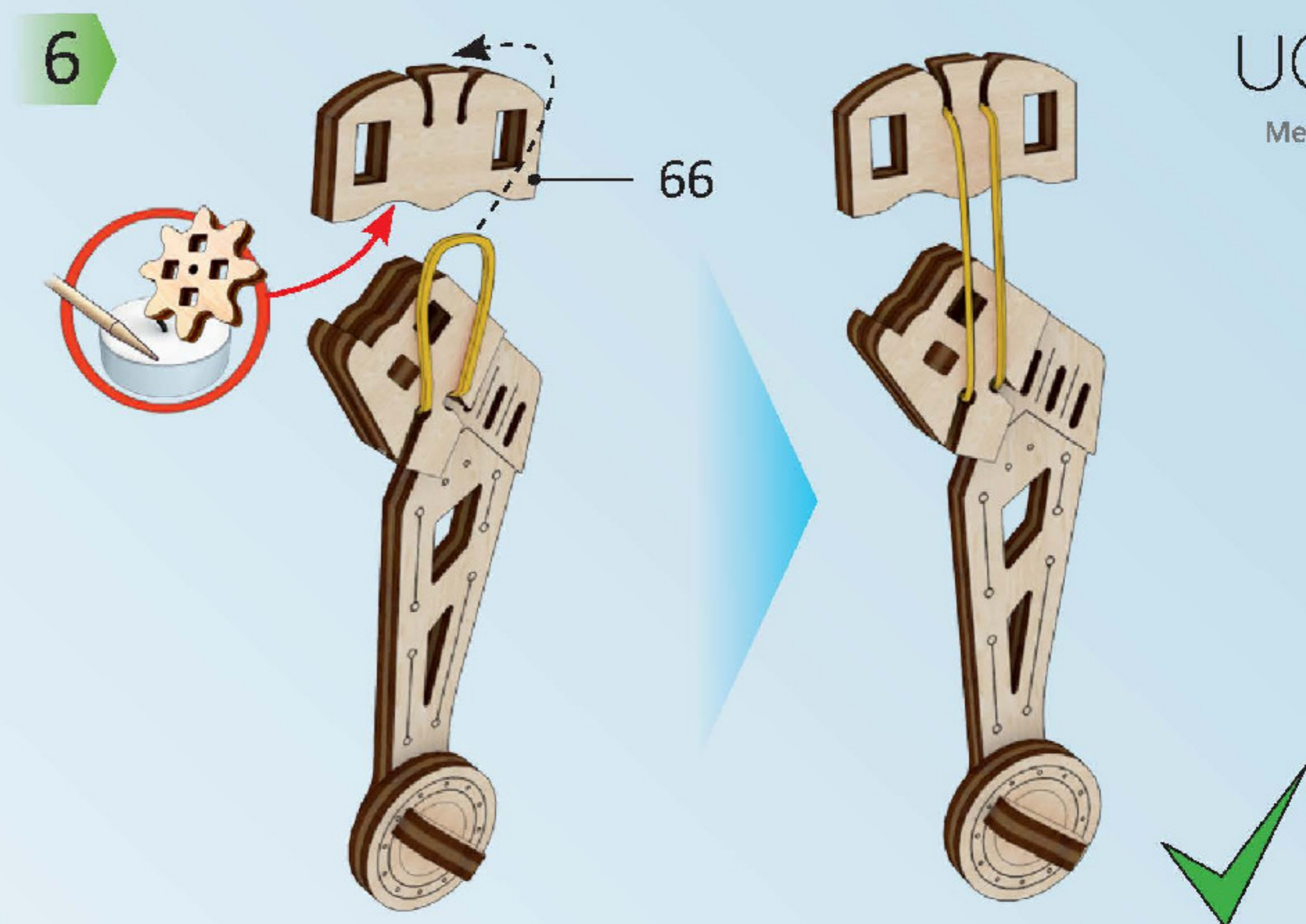
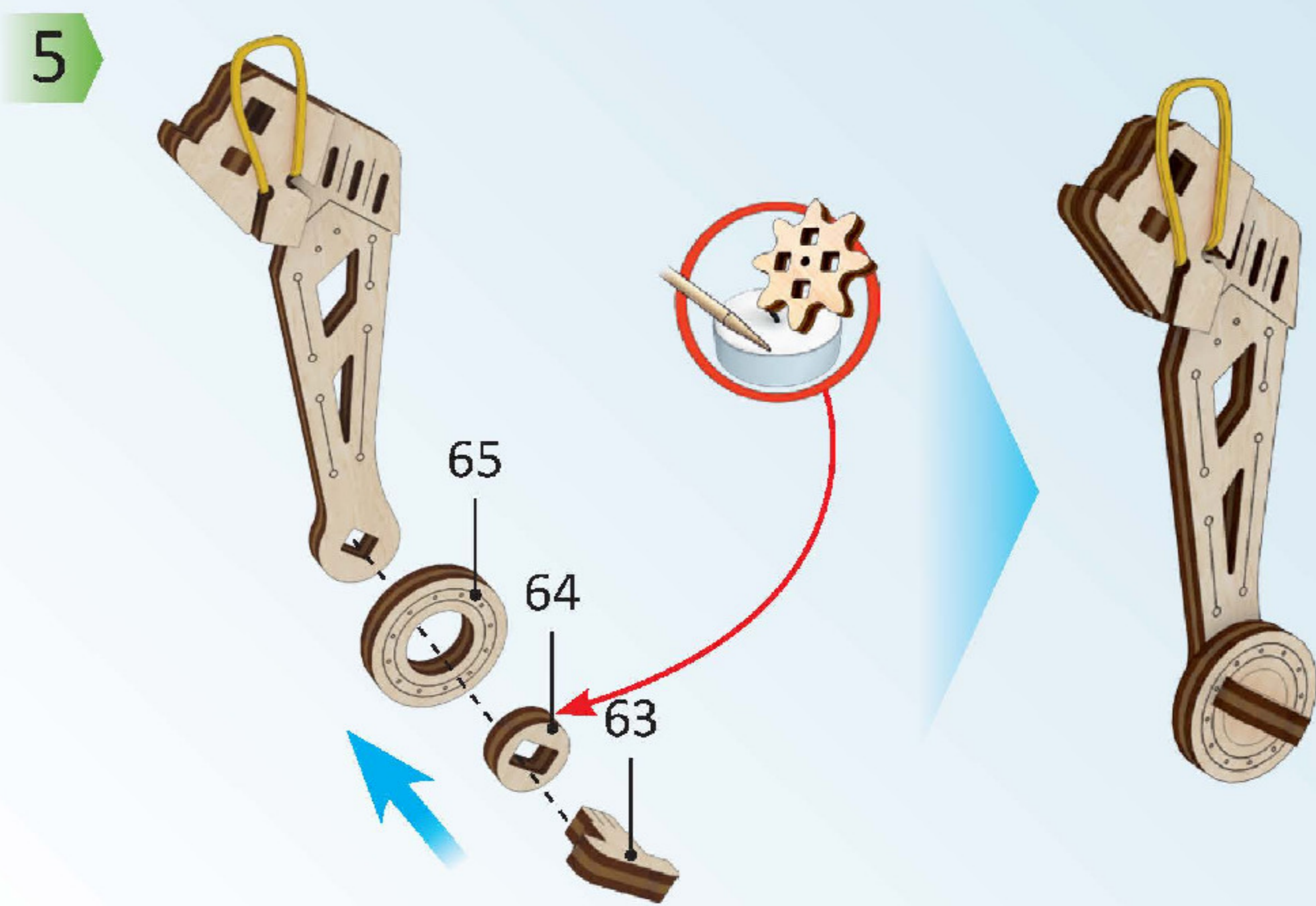
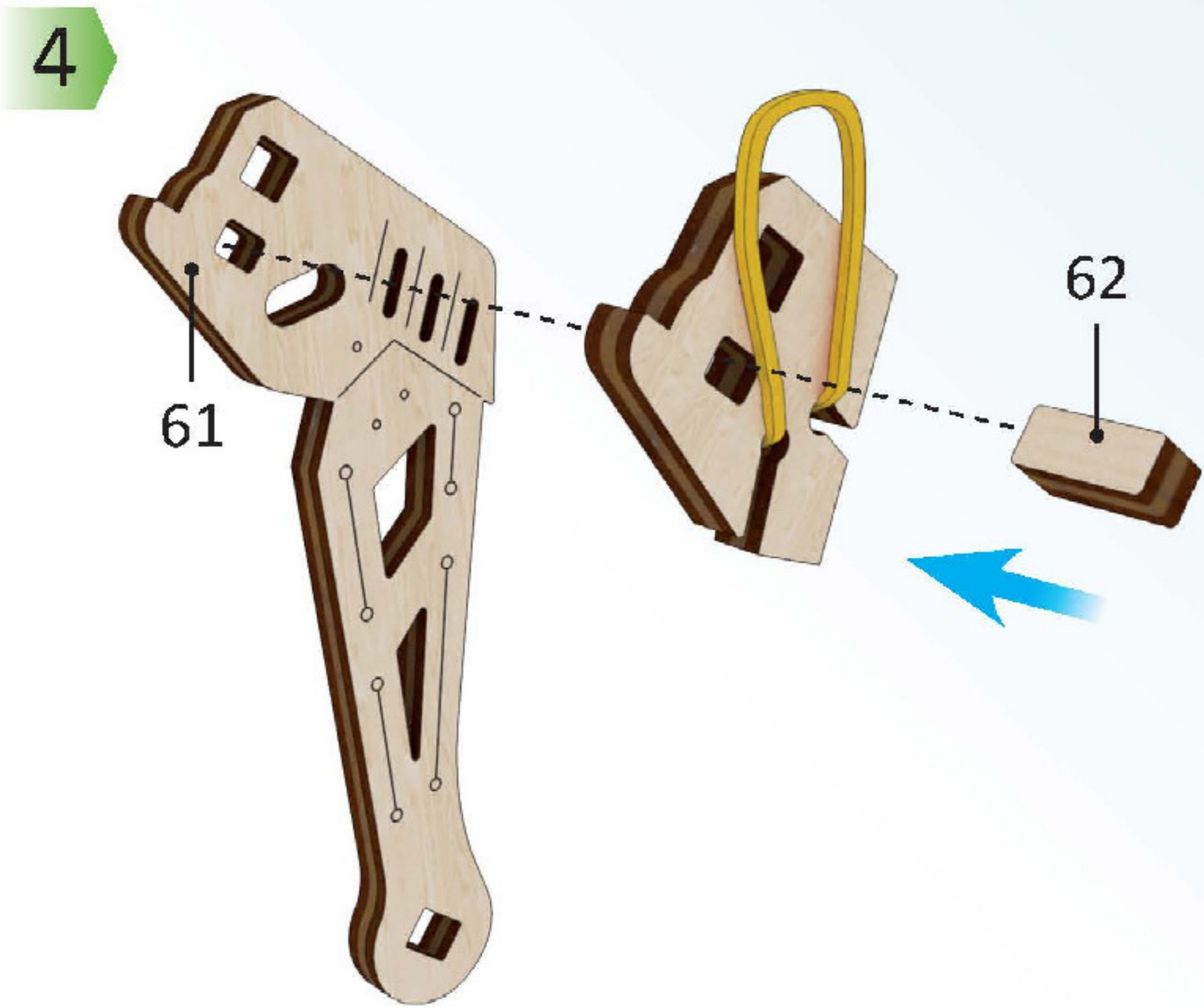

3

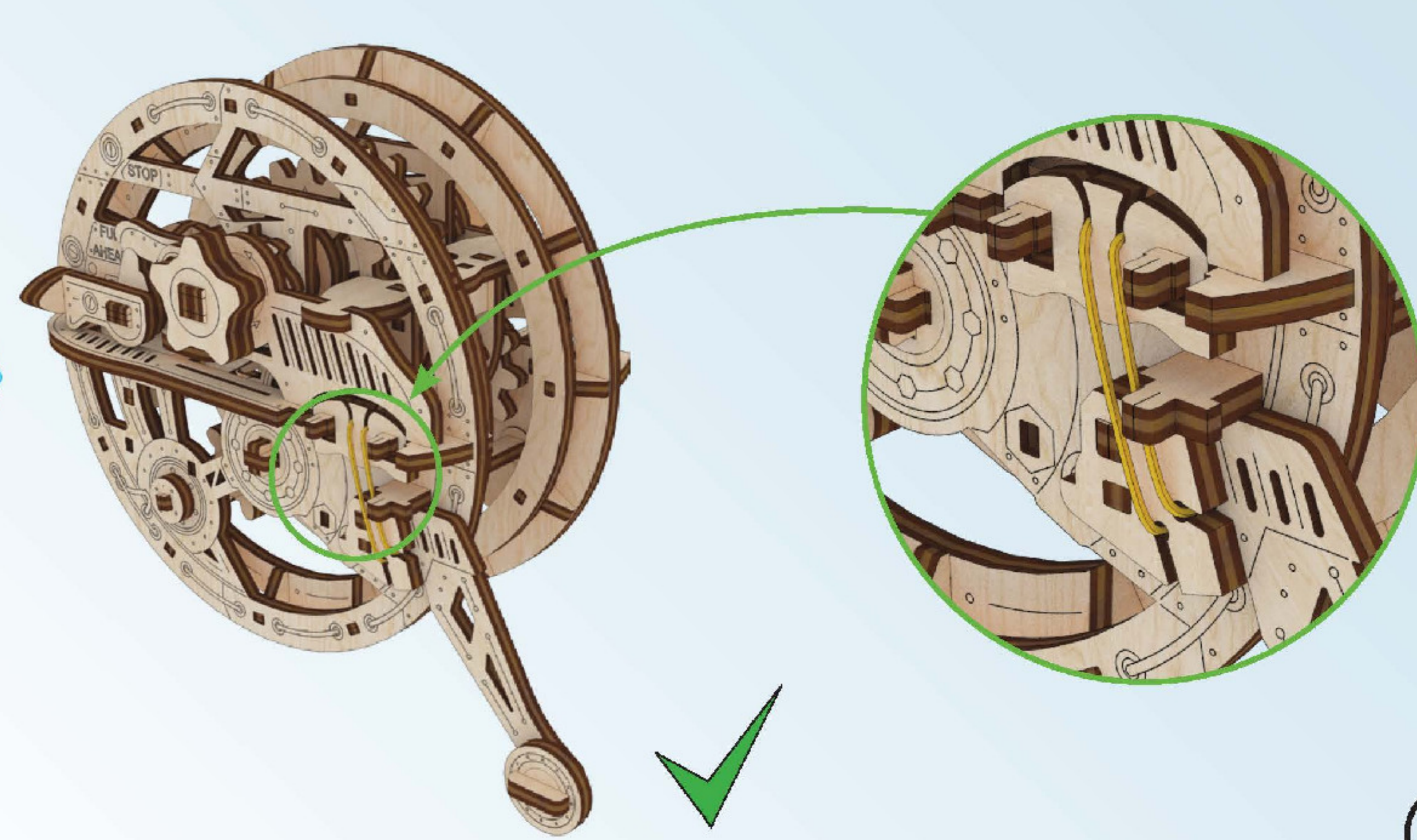
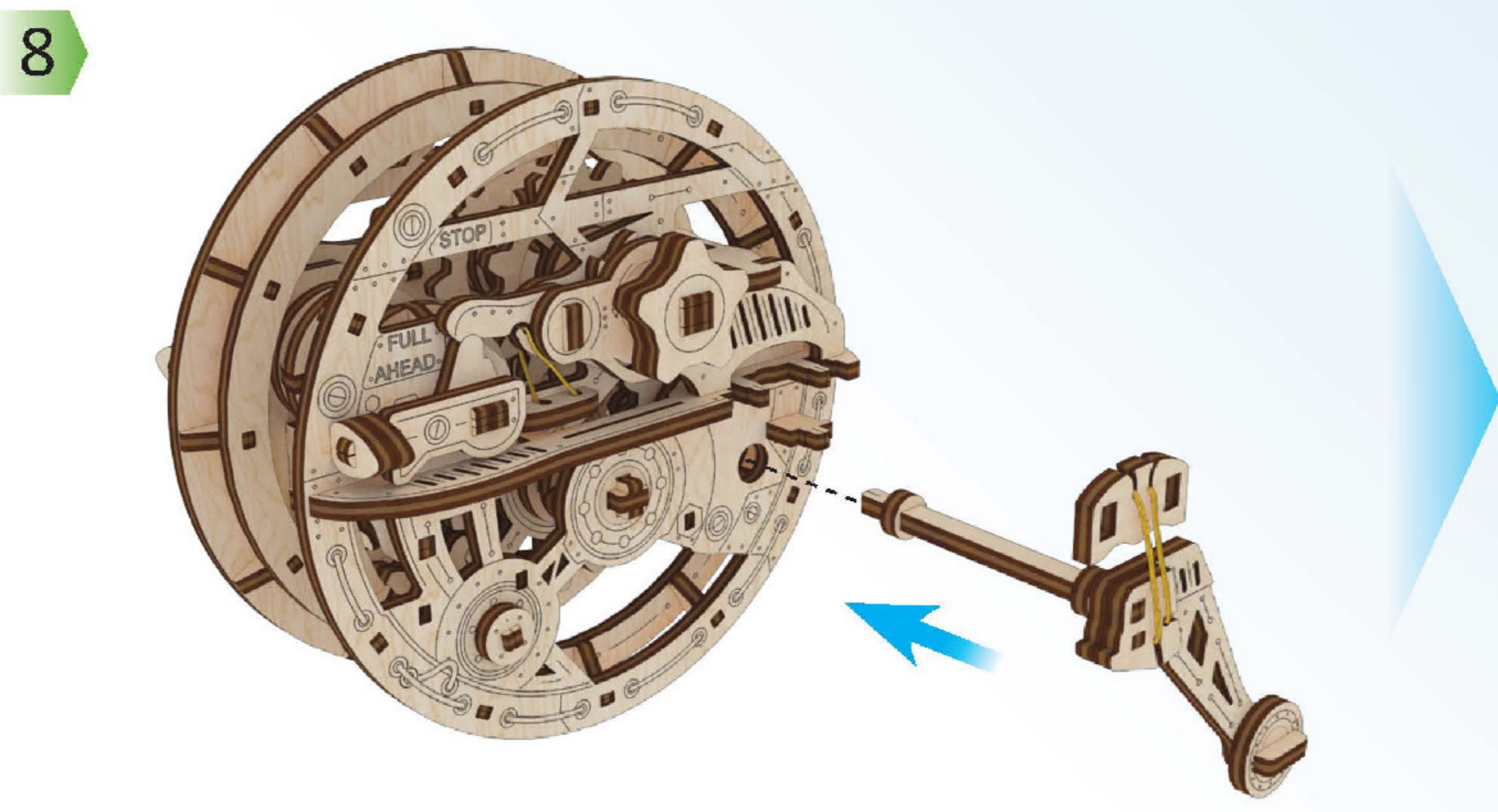
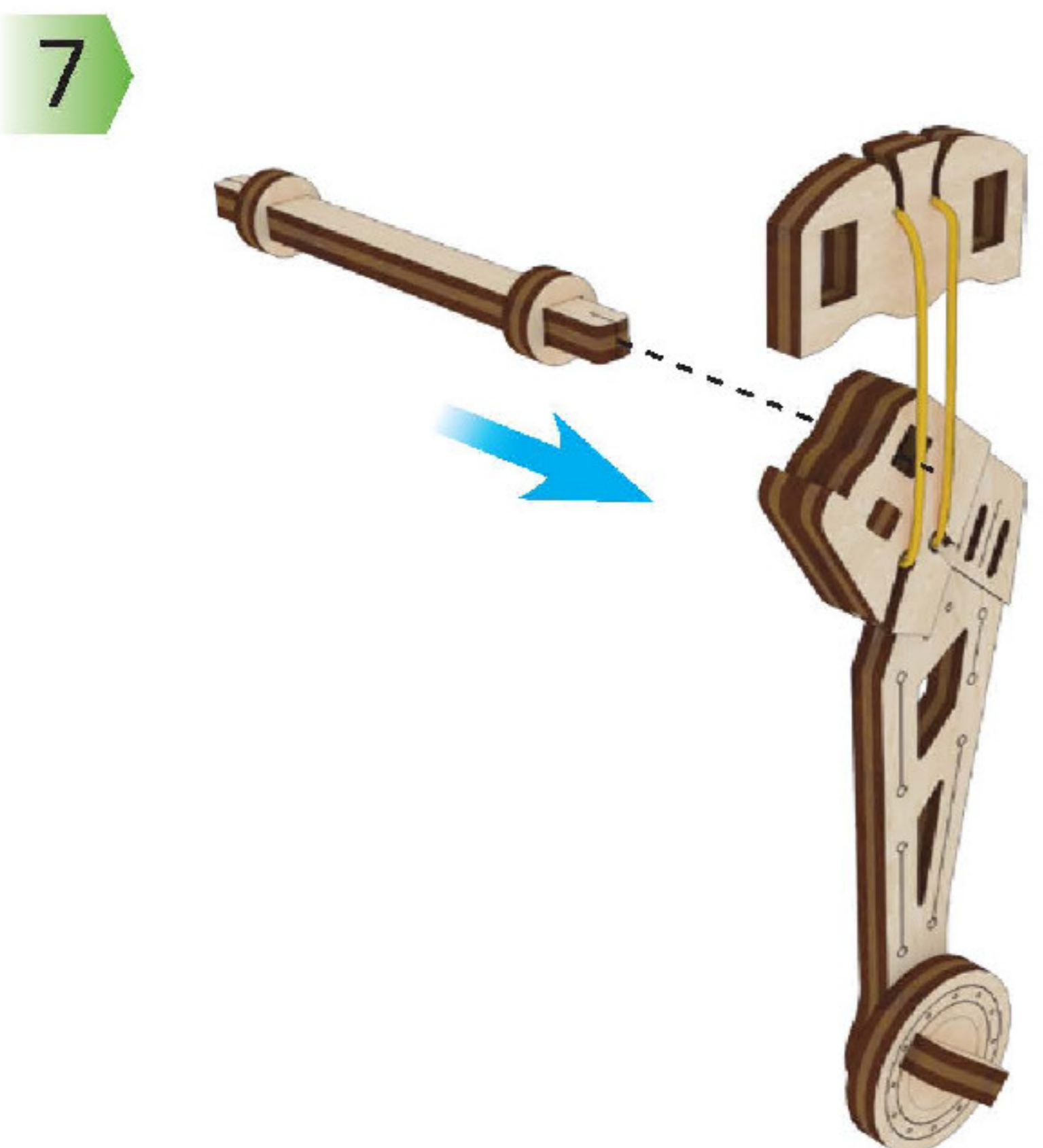

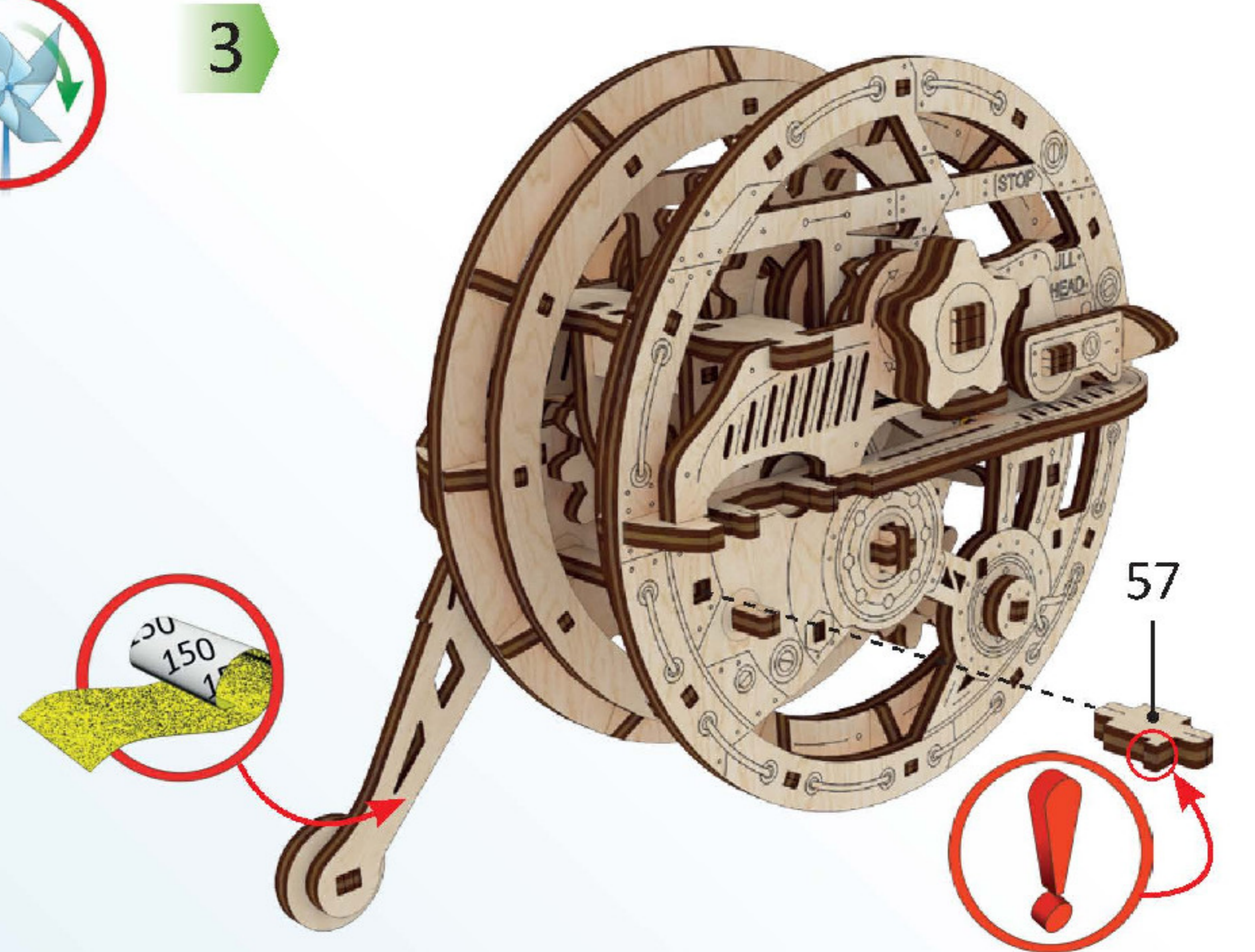
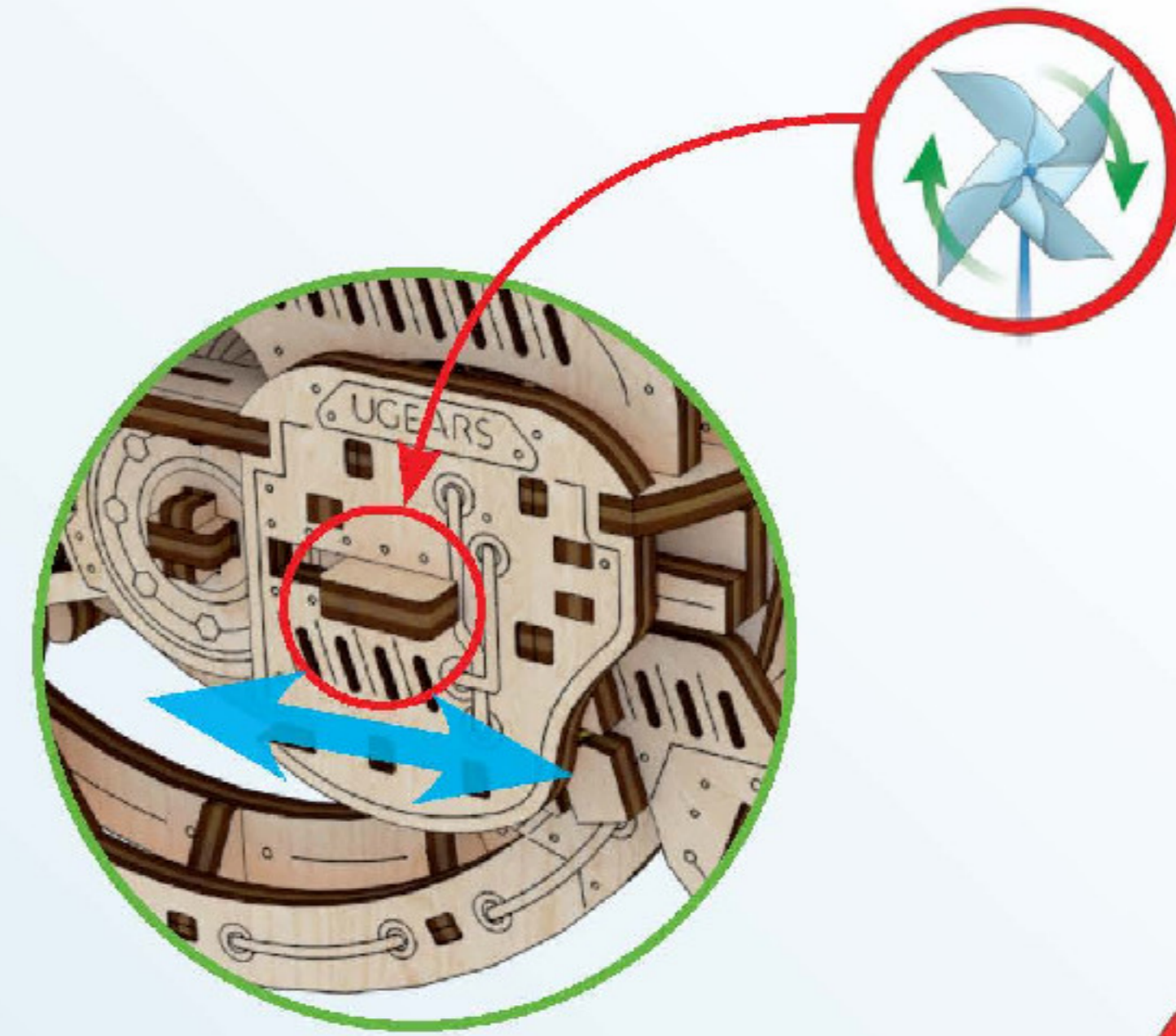
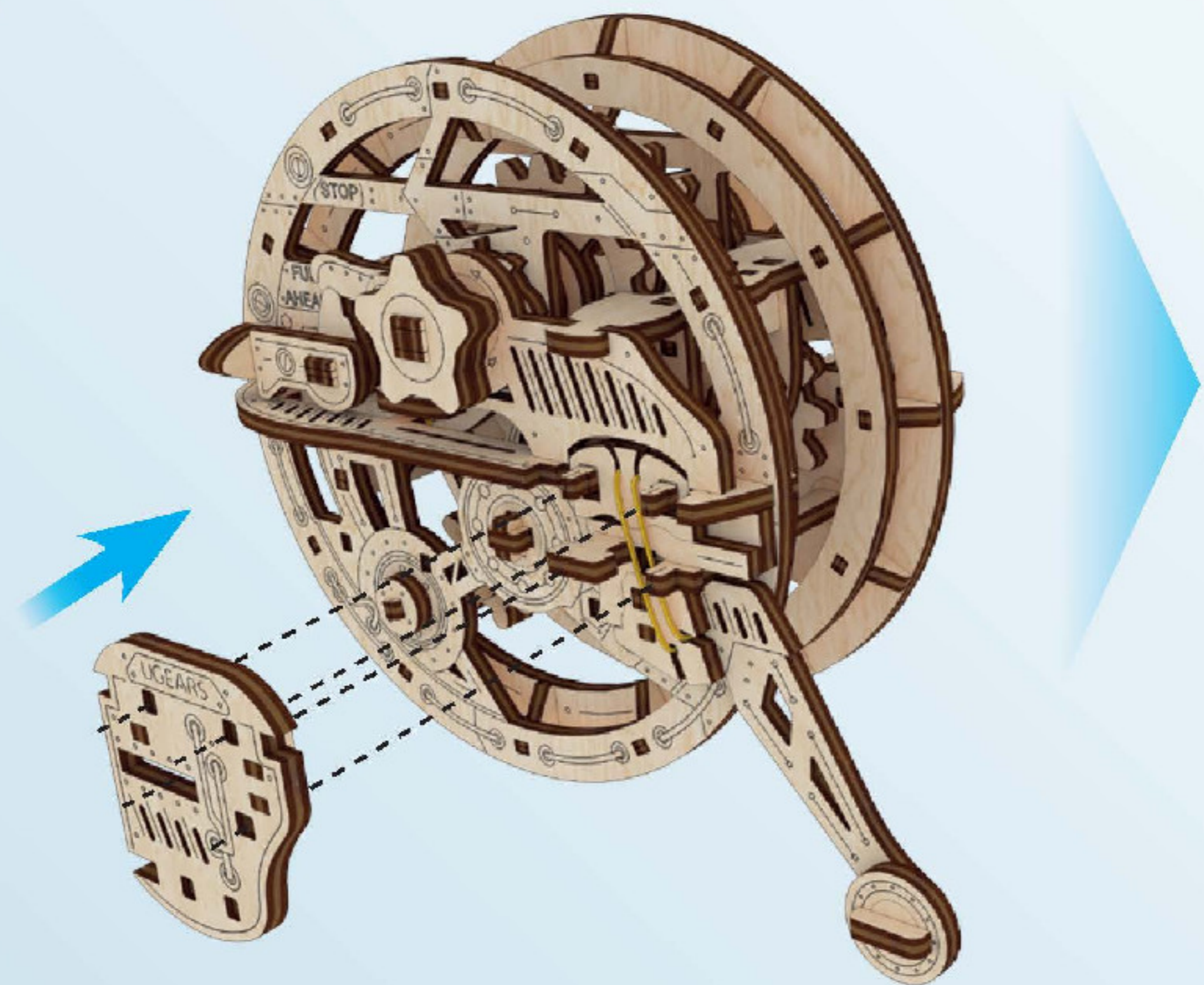
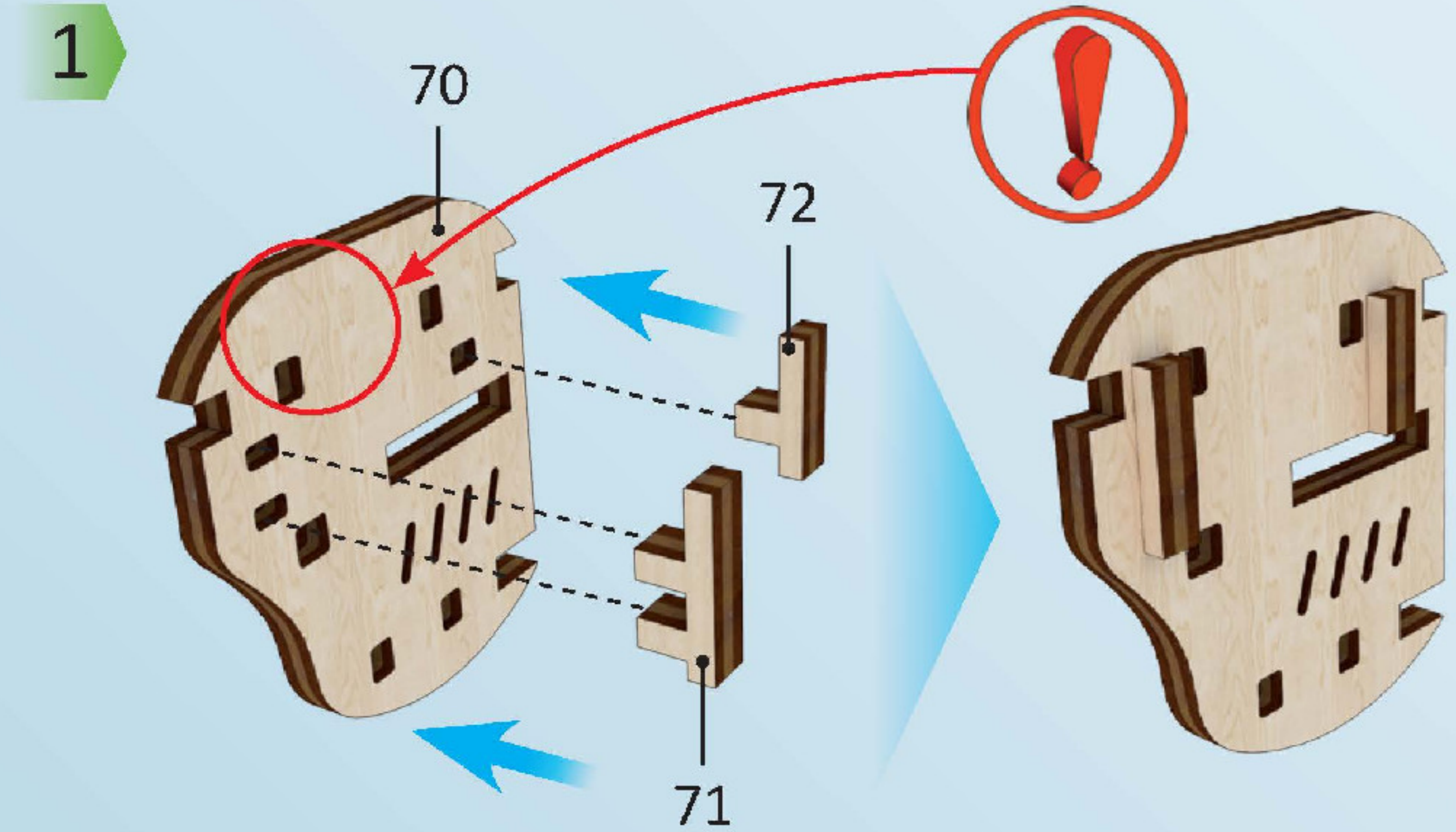
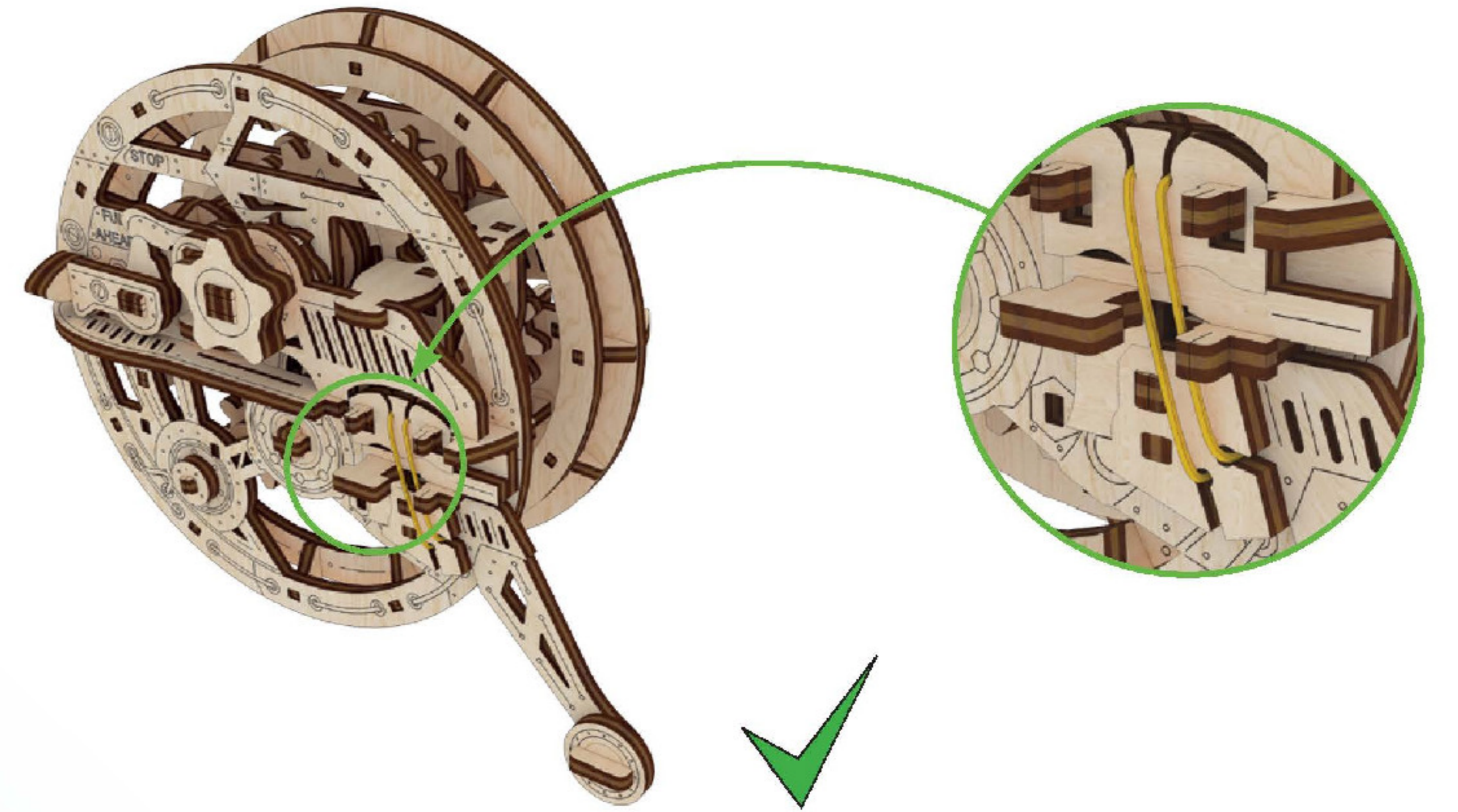
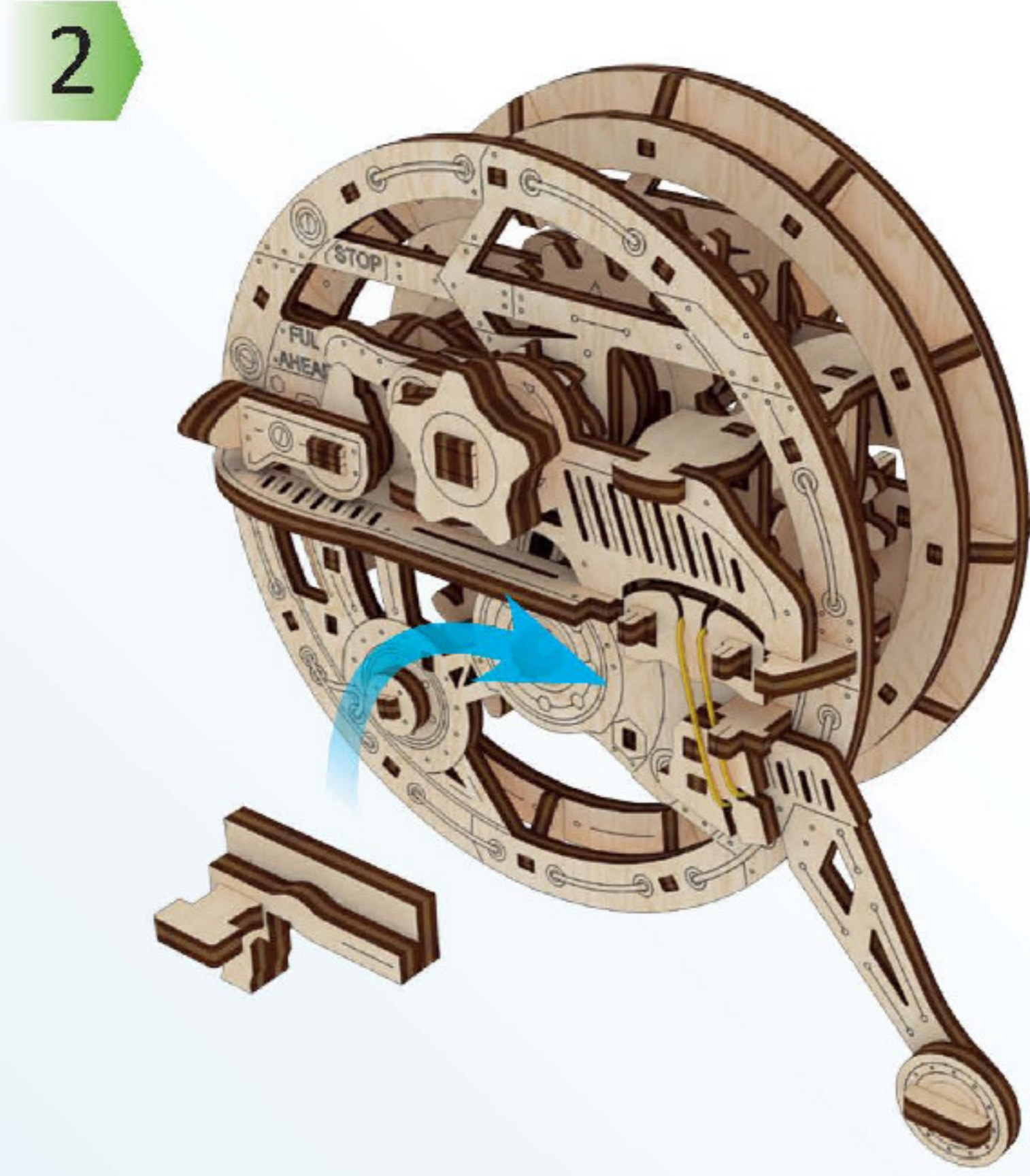
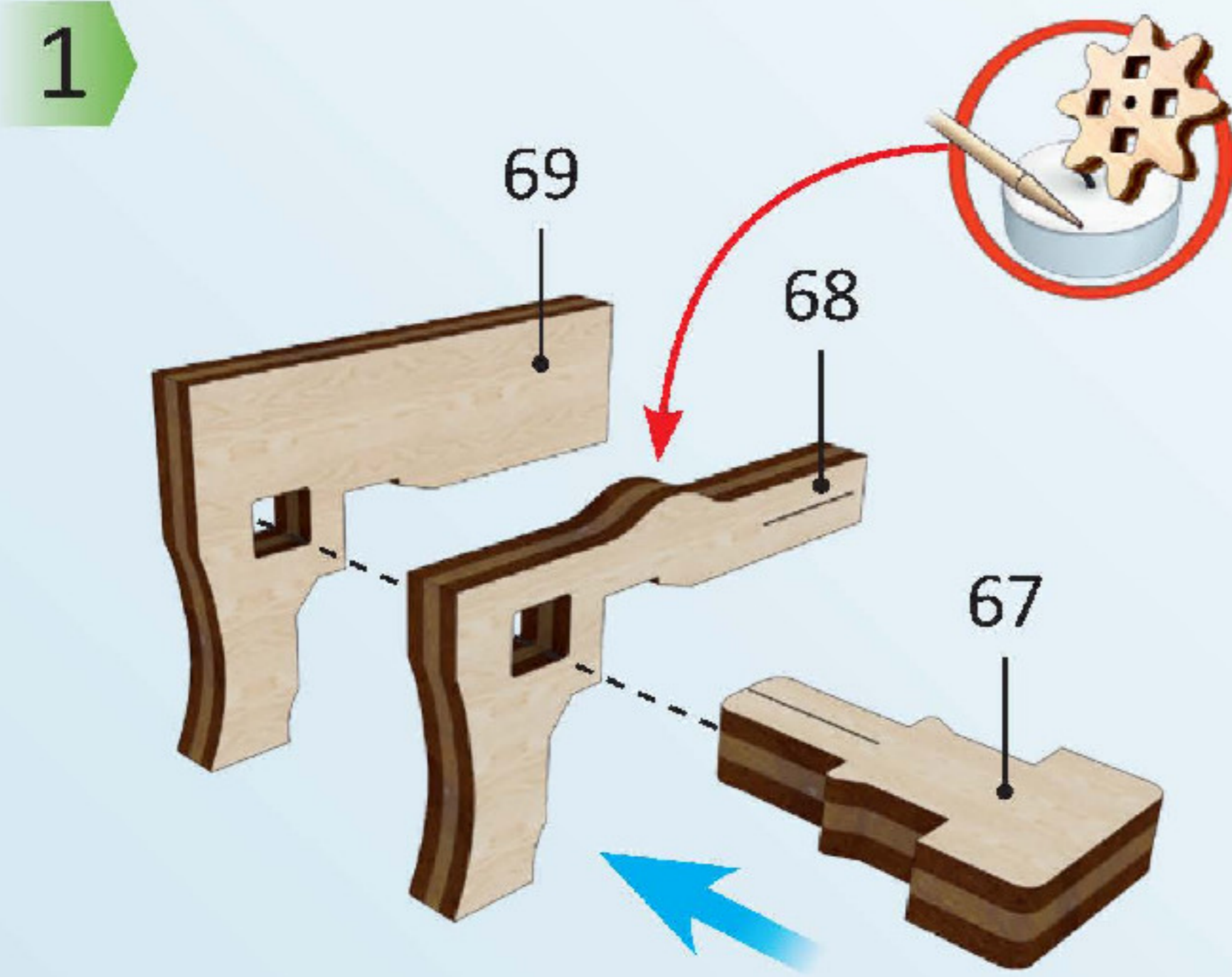
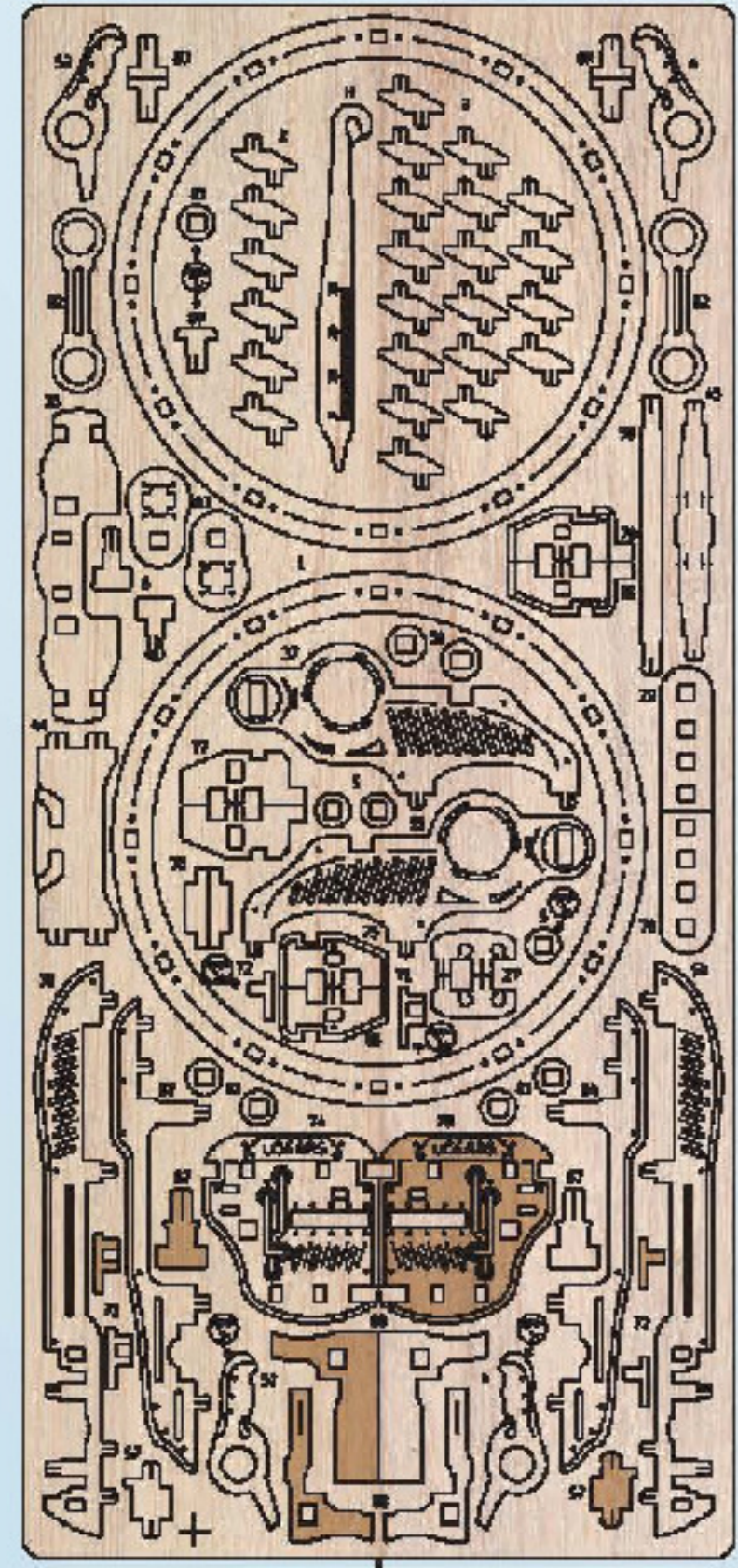

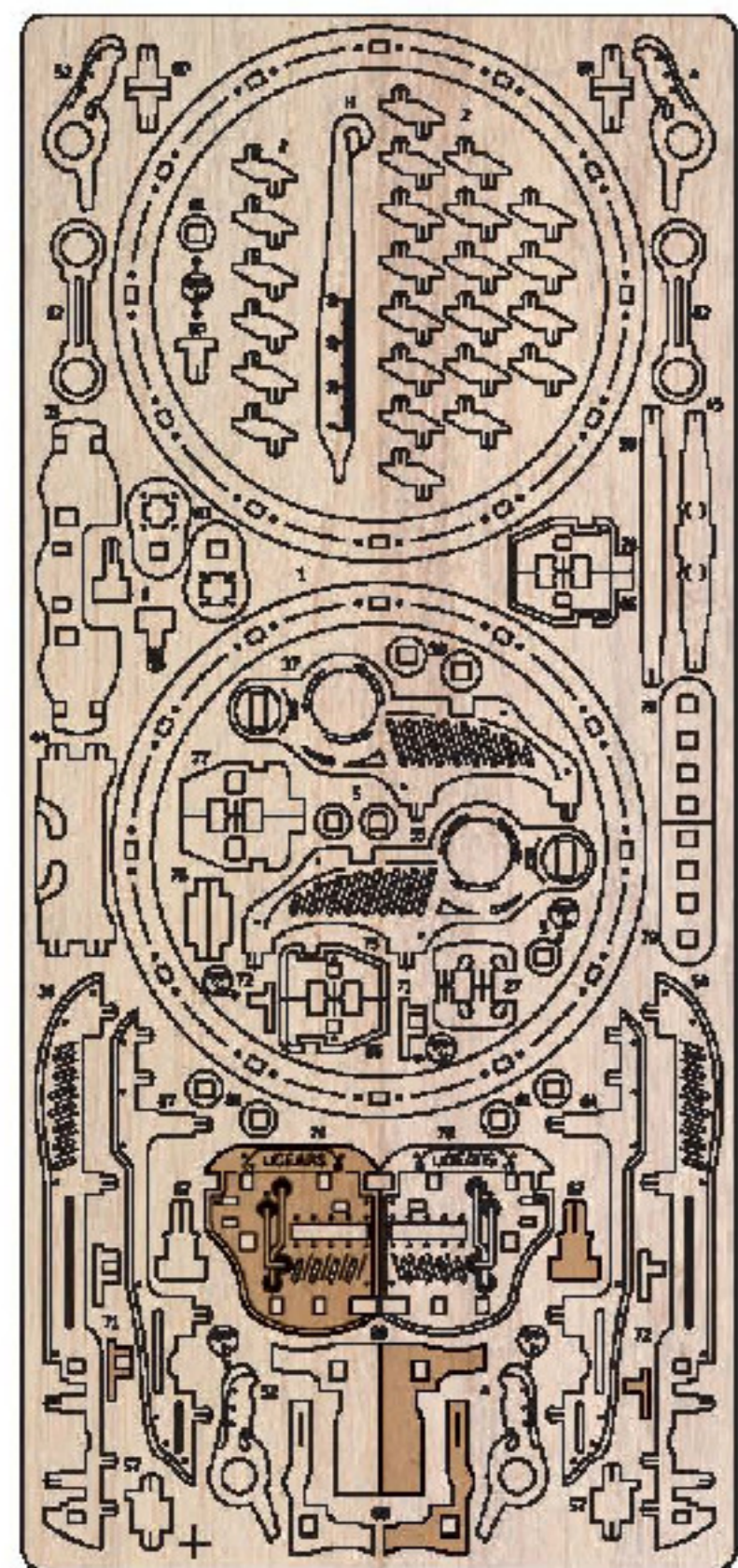

1

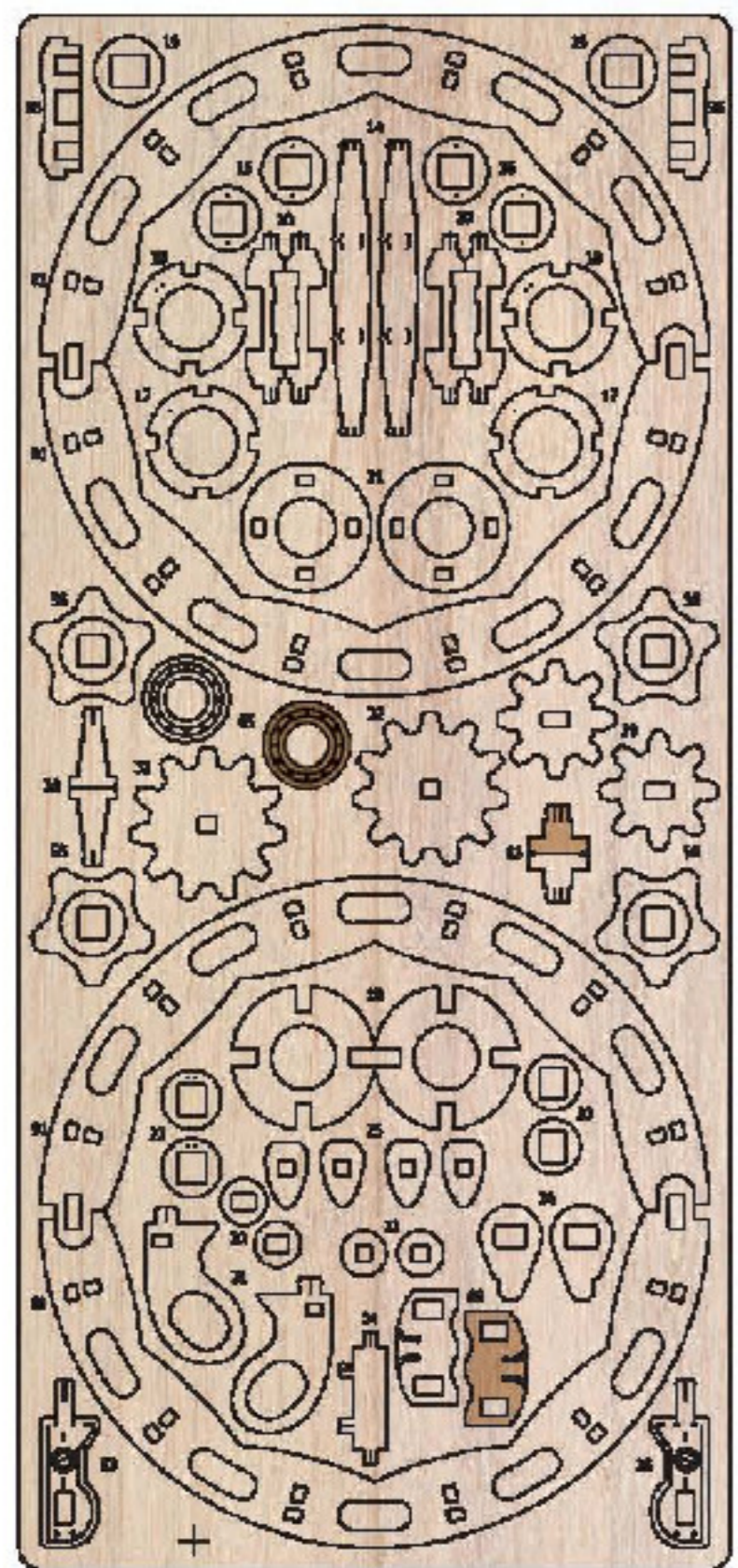

2

1

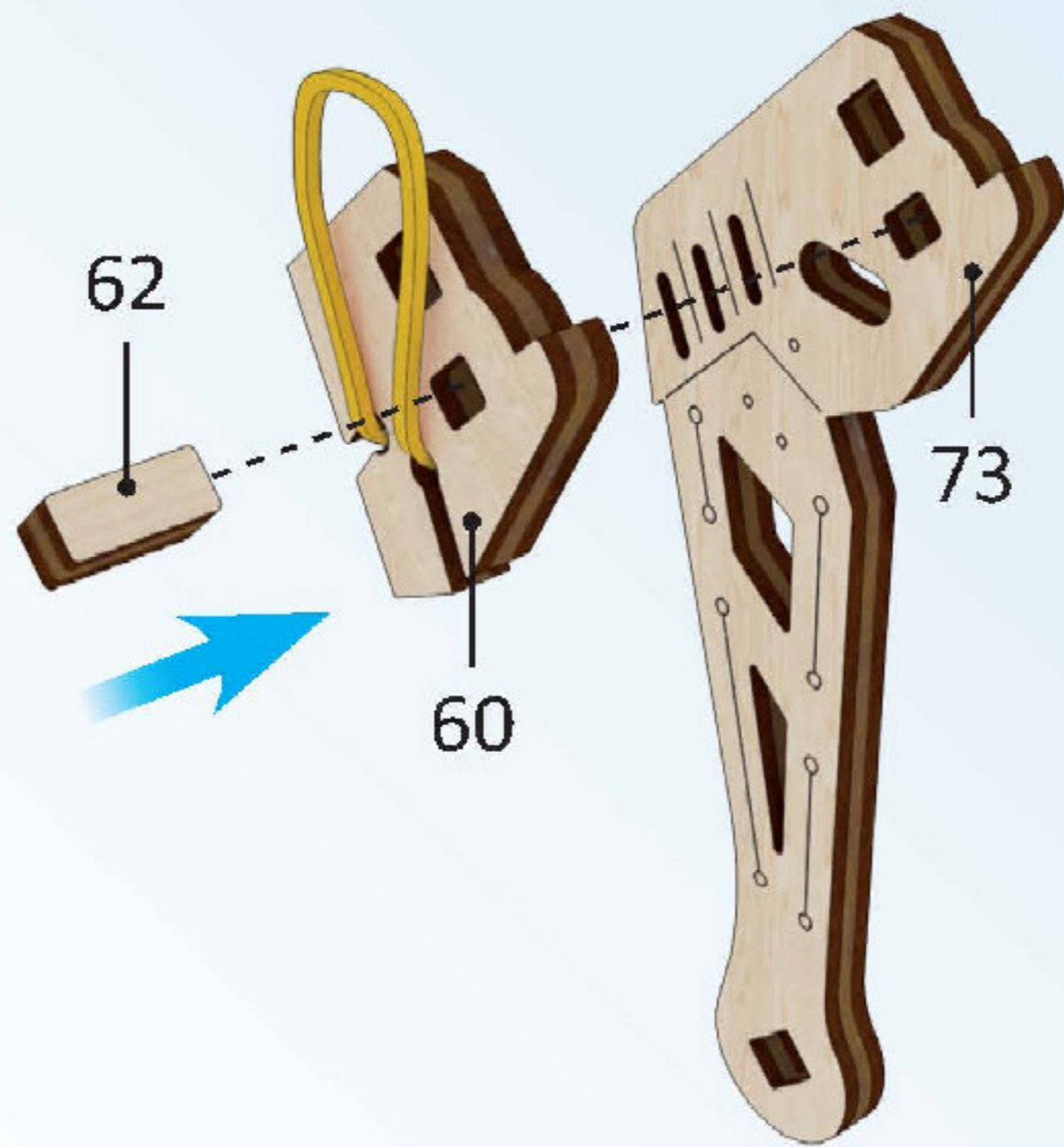
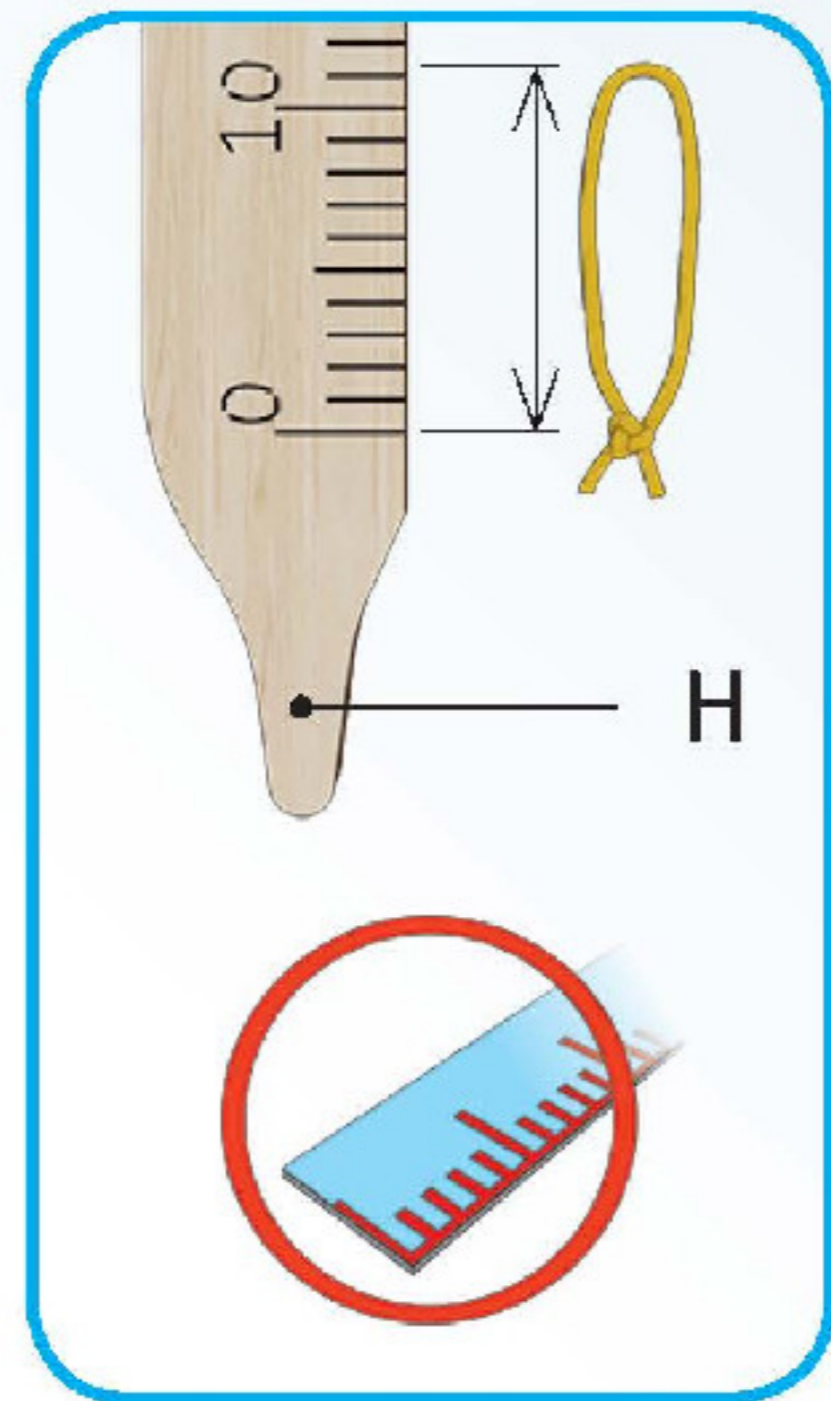

2

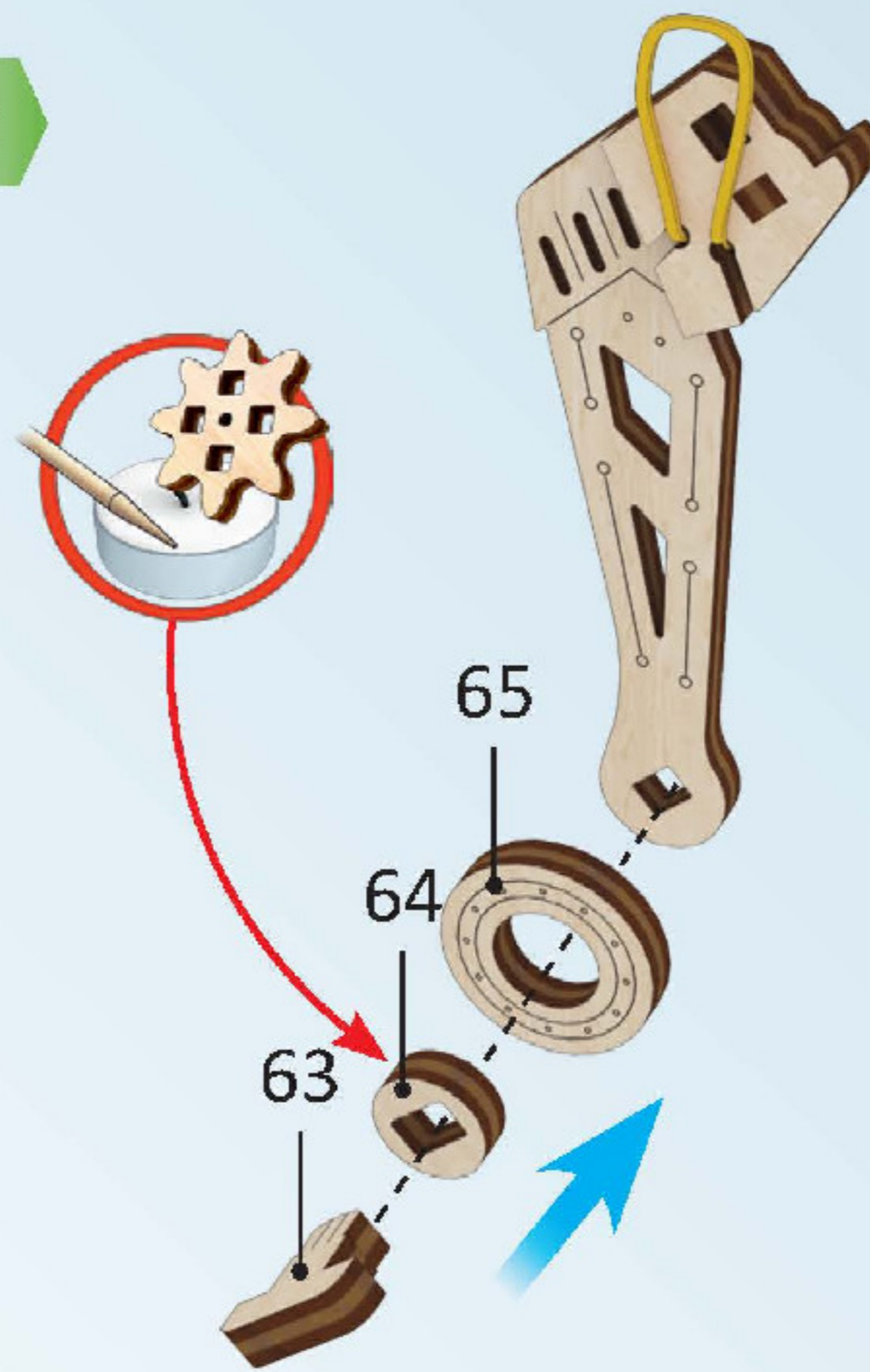

3

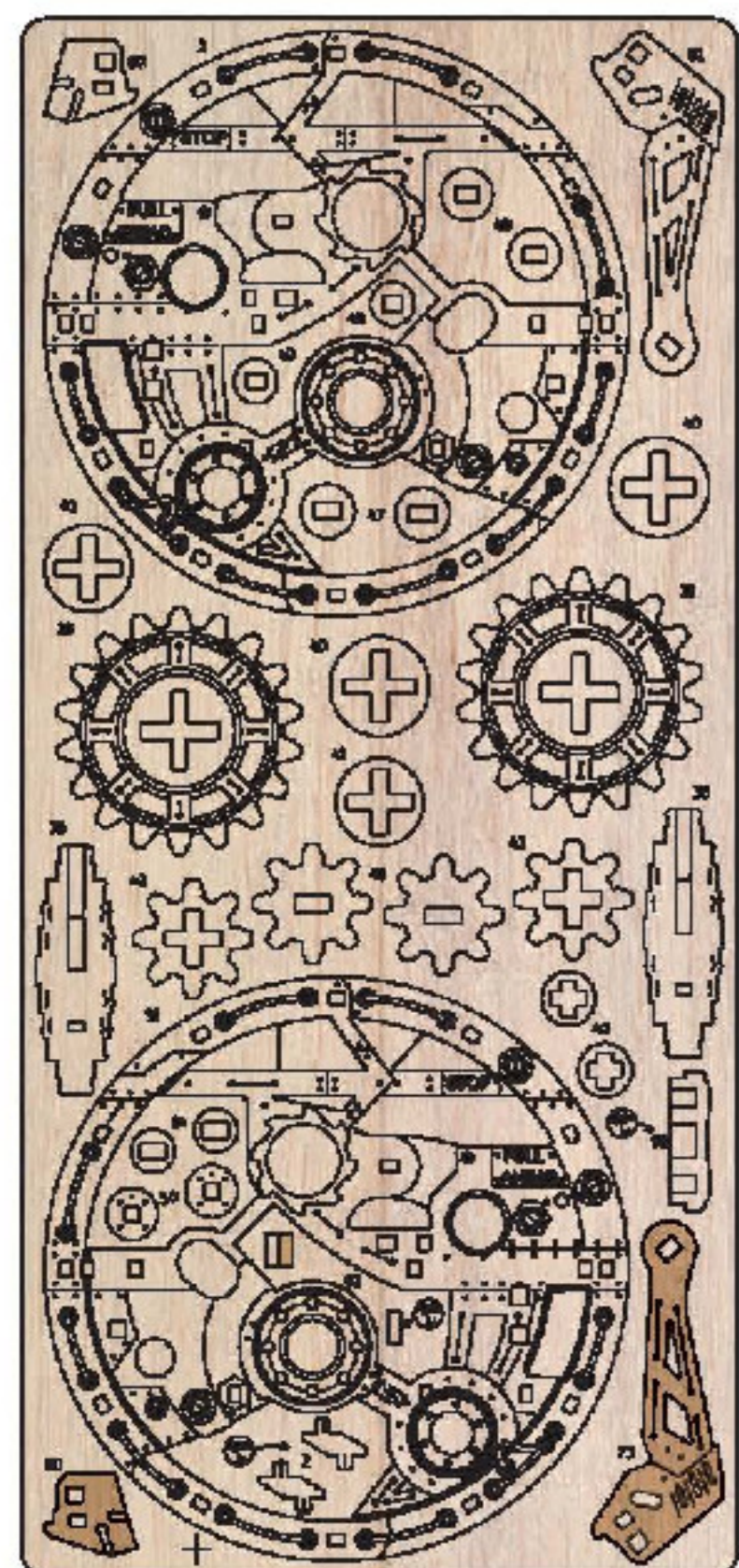
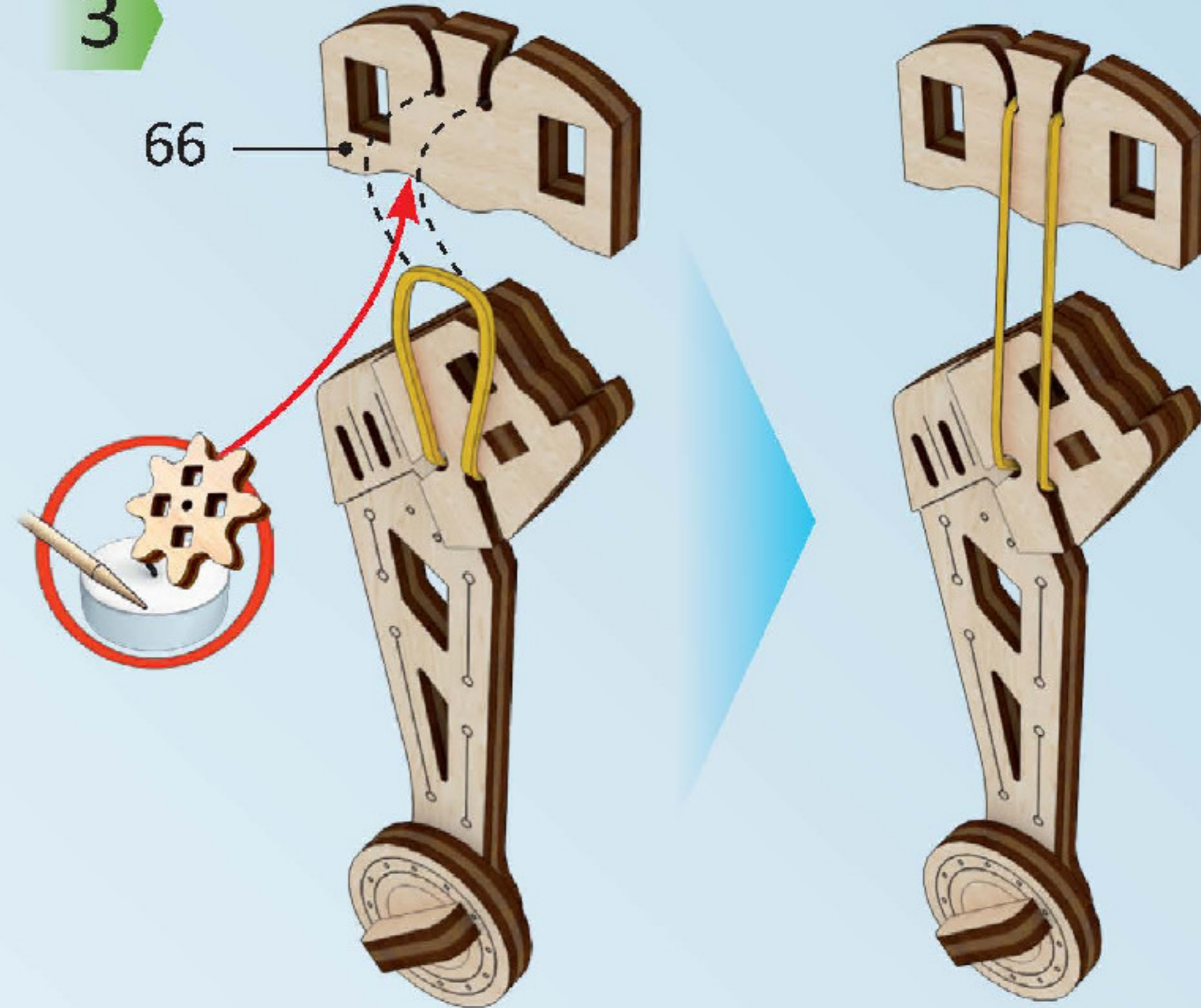

3

4

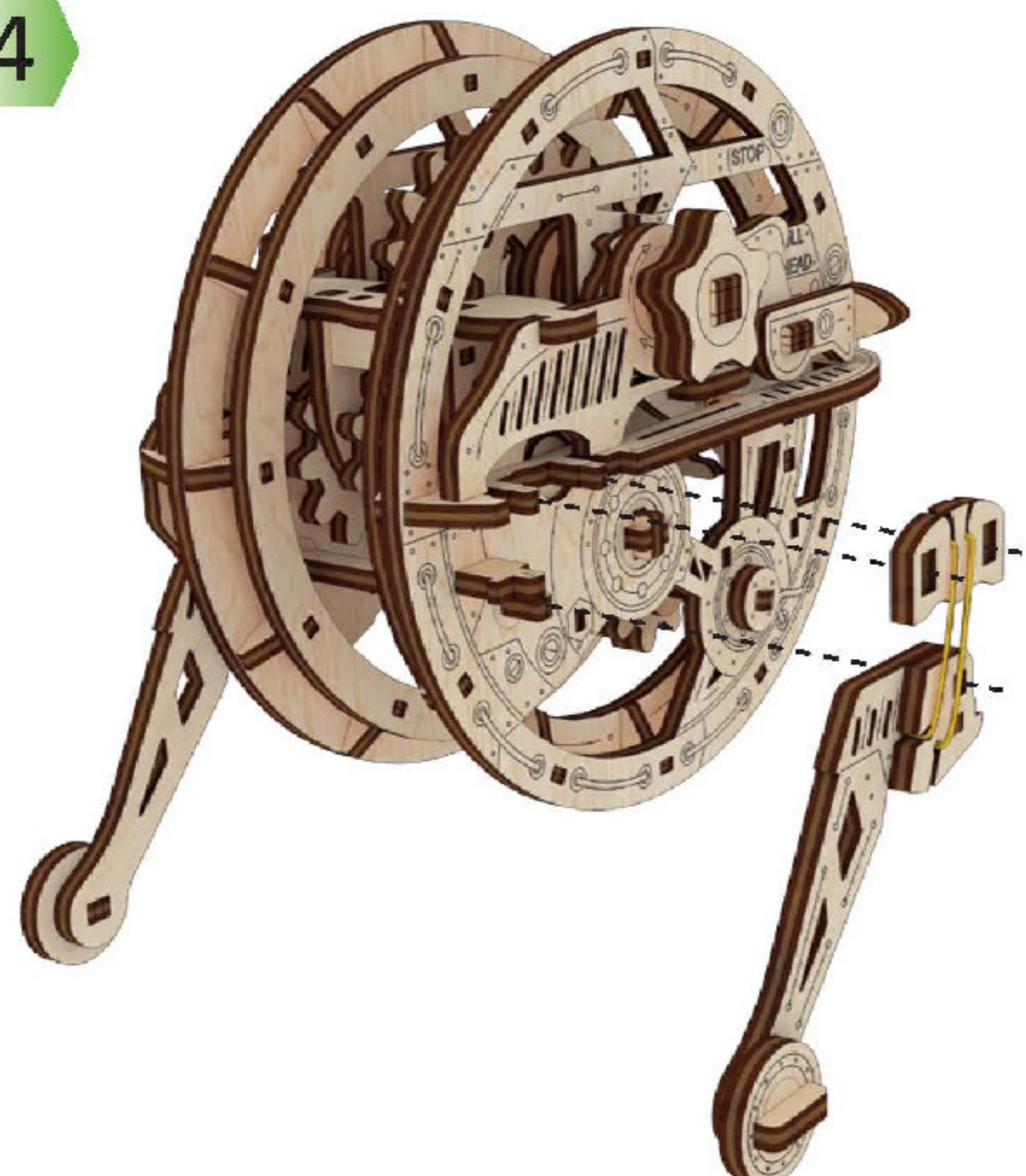

5

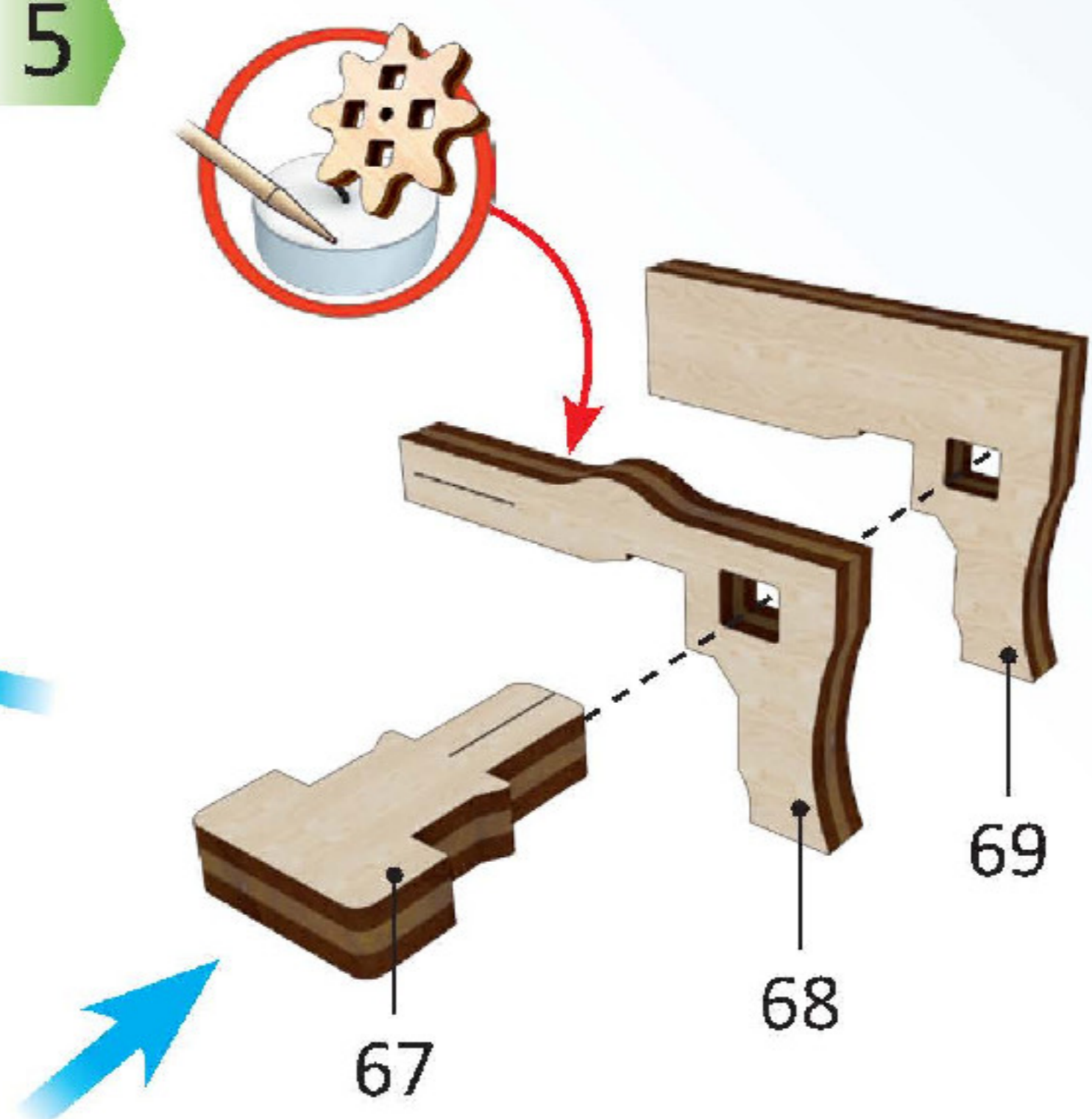

6

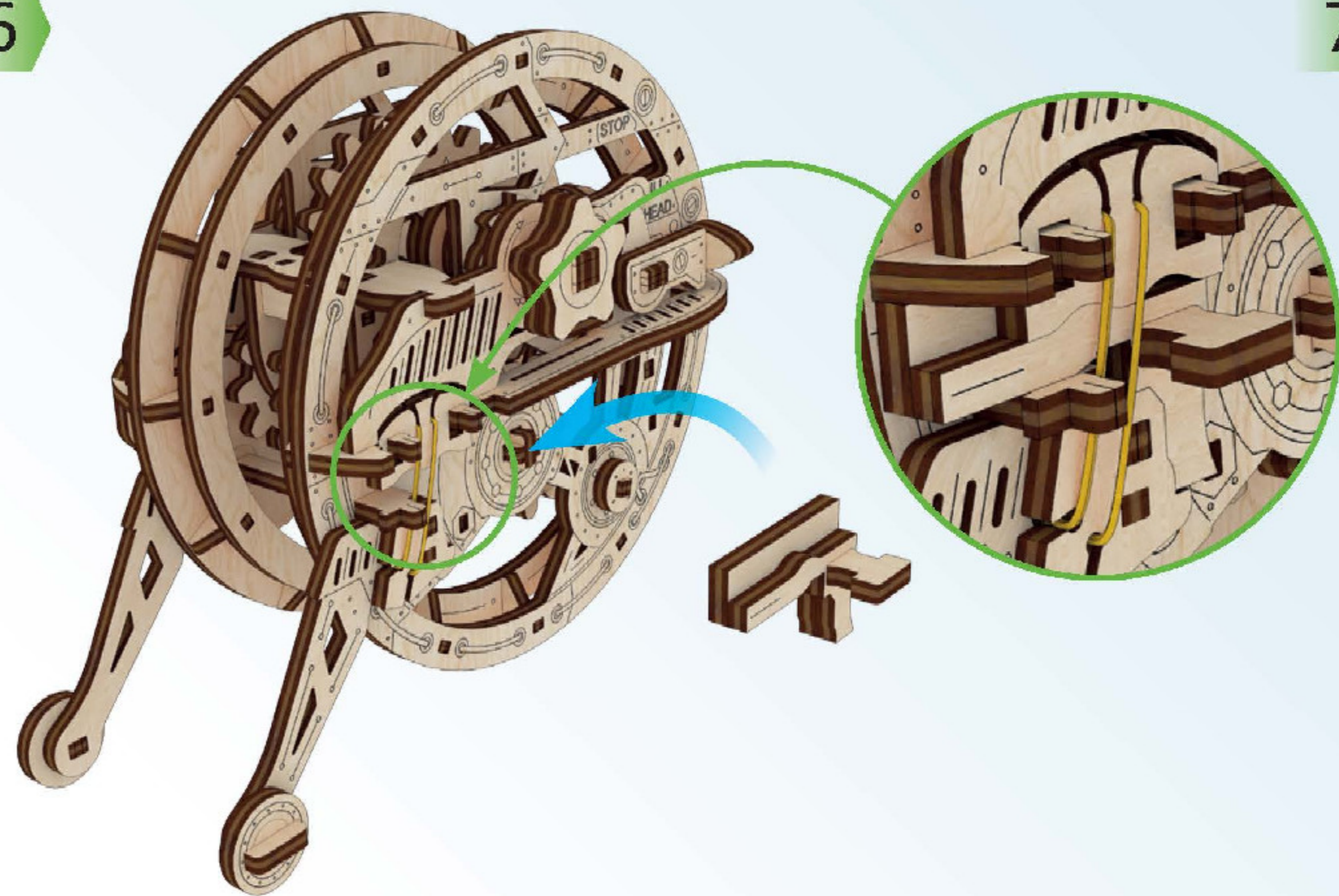

7

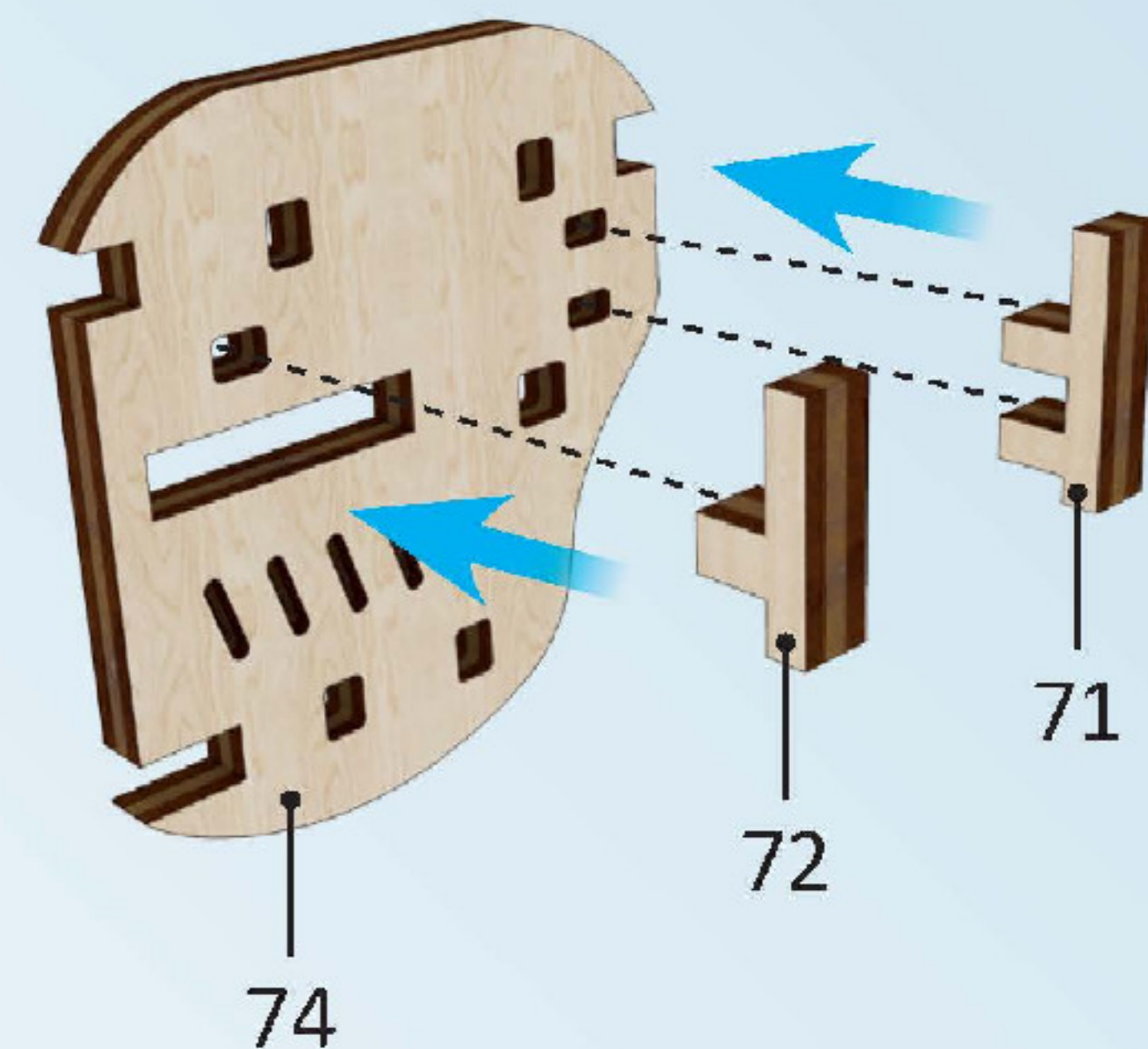

8

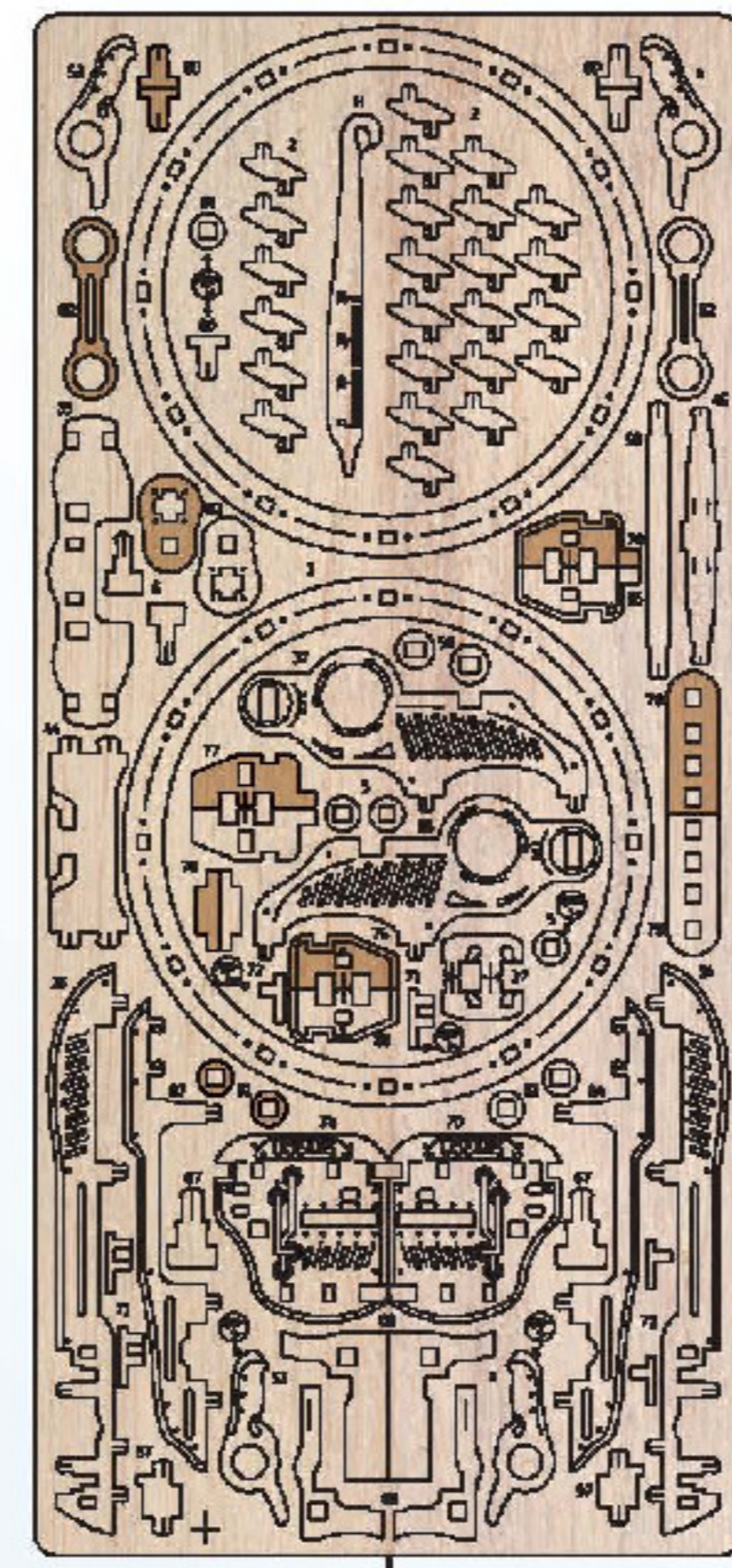
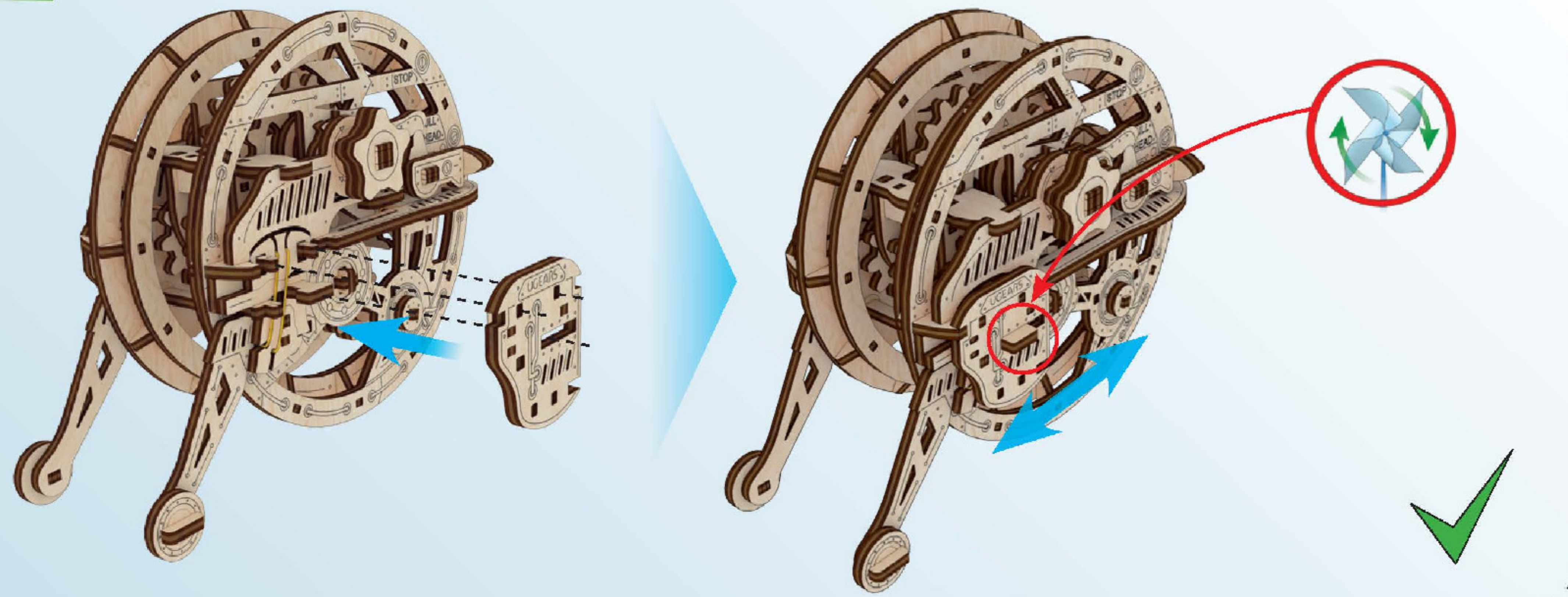

1

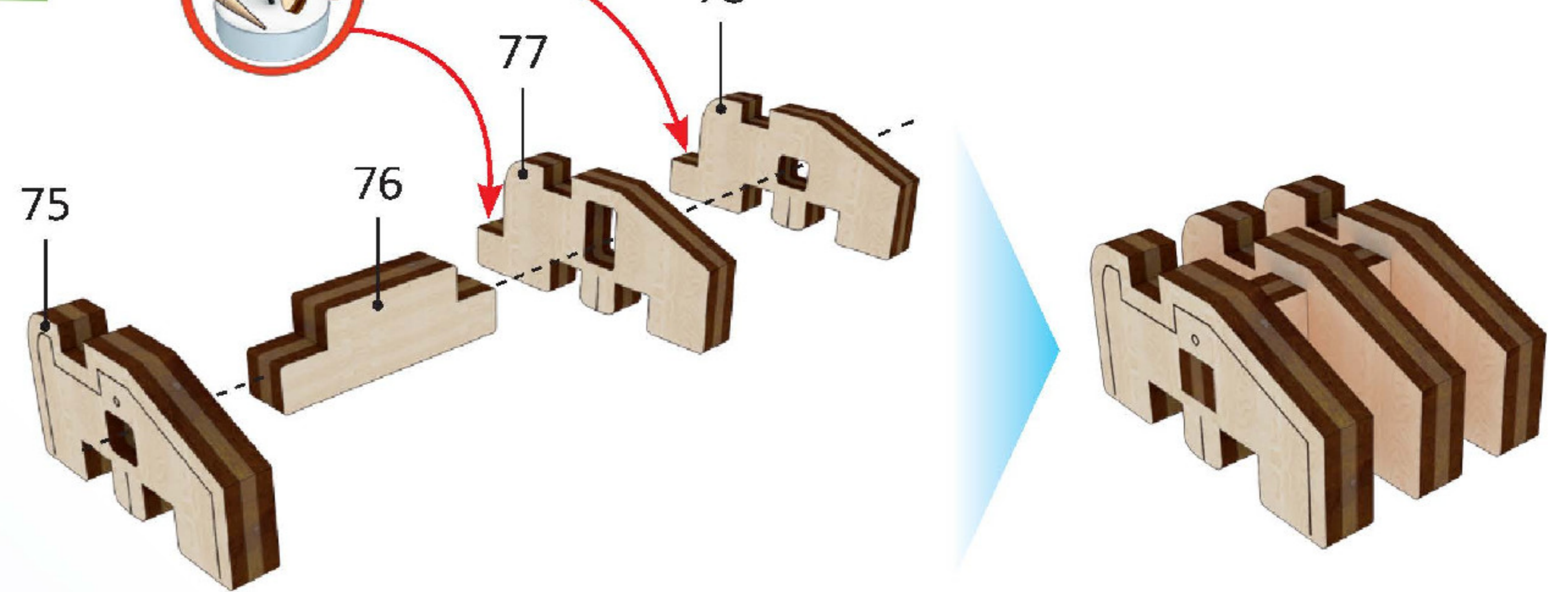

2

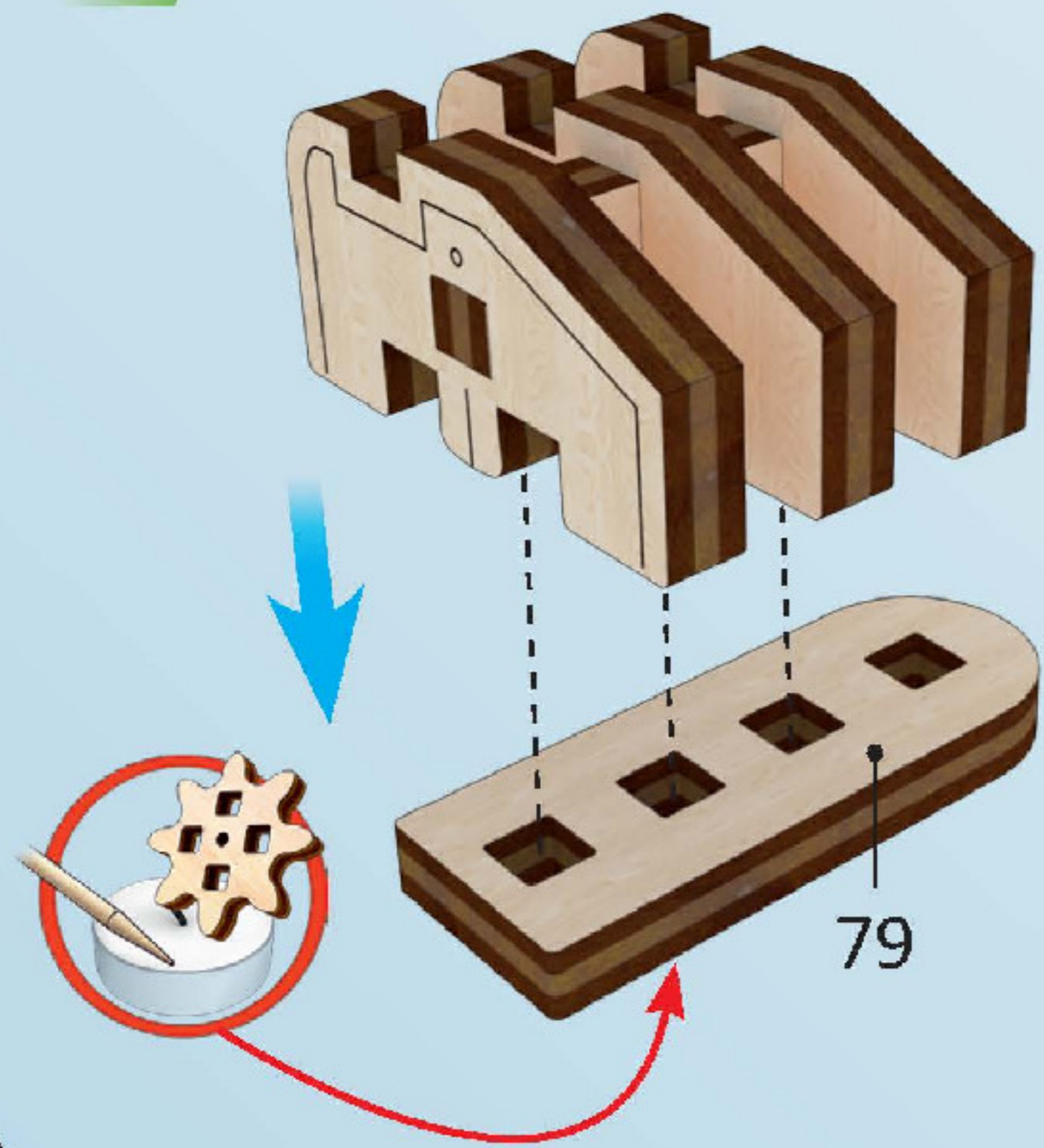

3

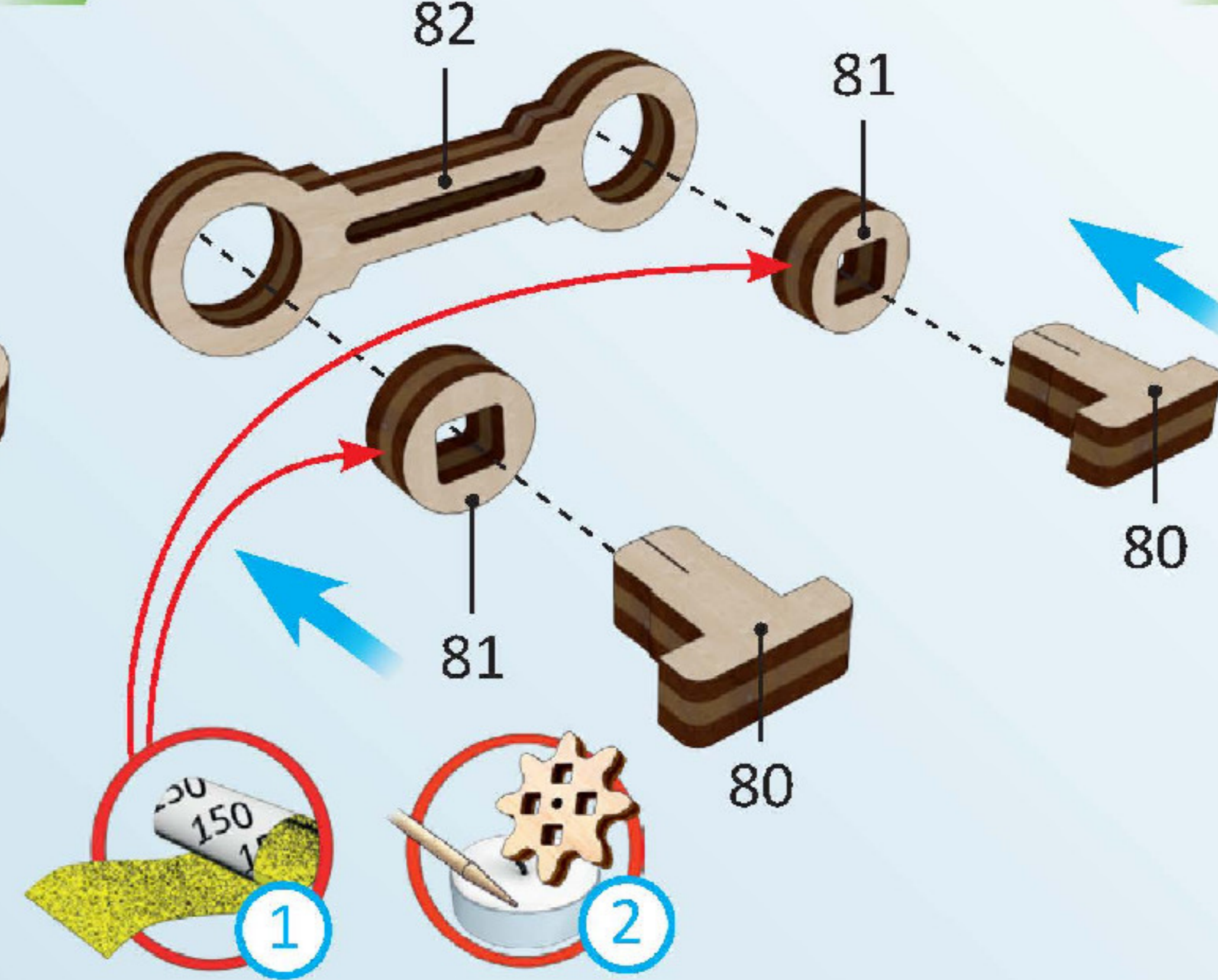

4

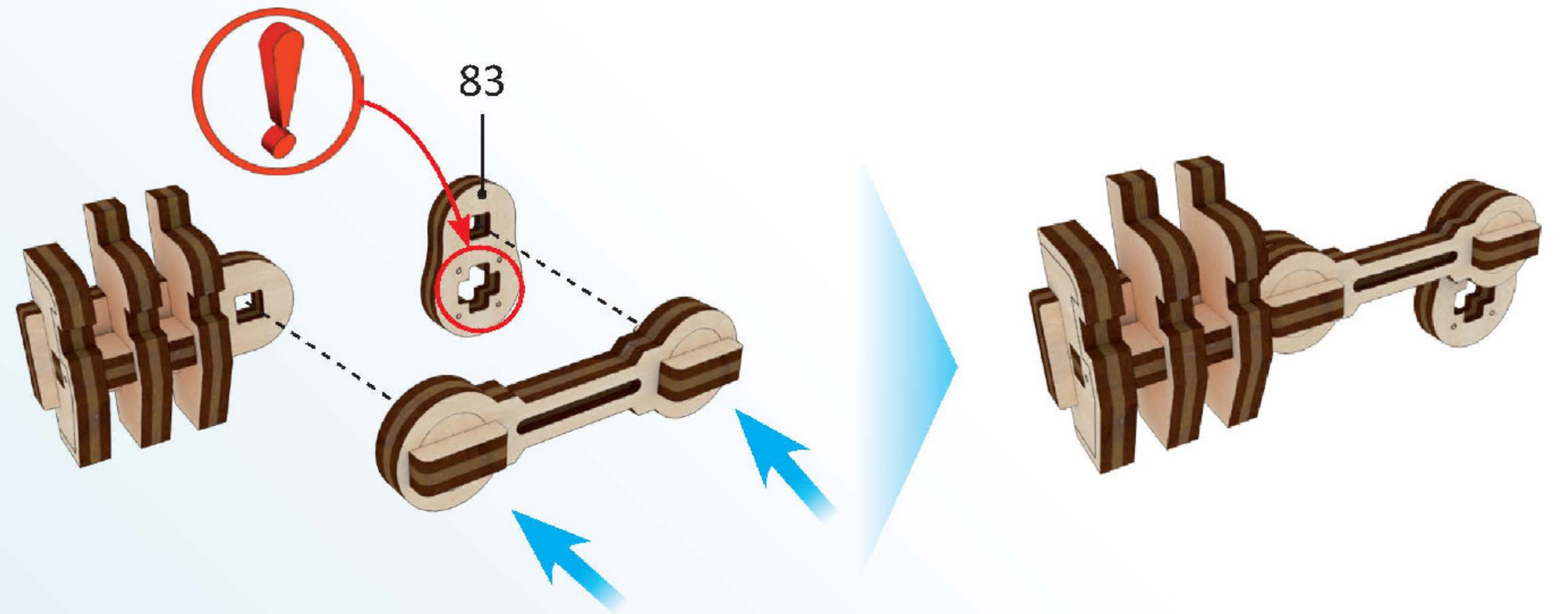

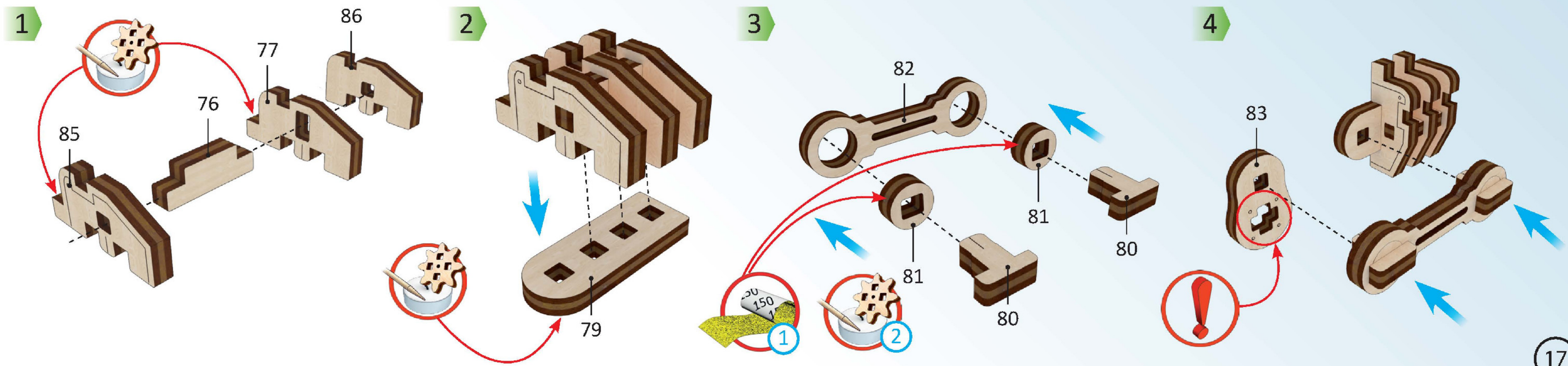
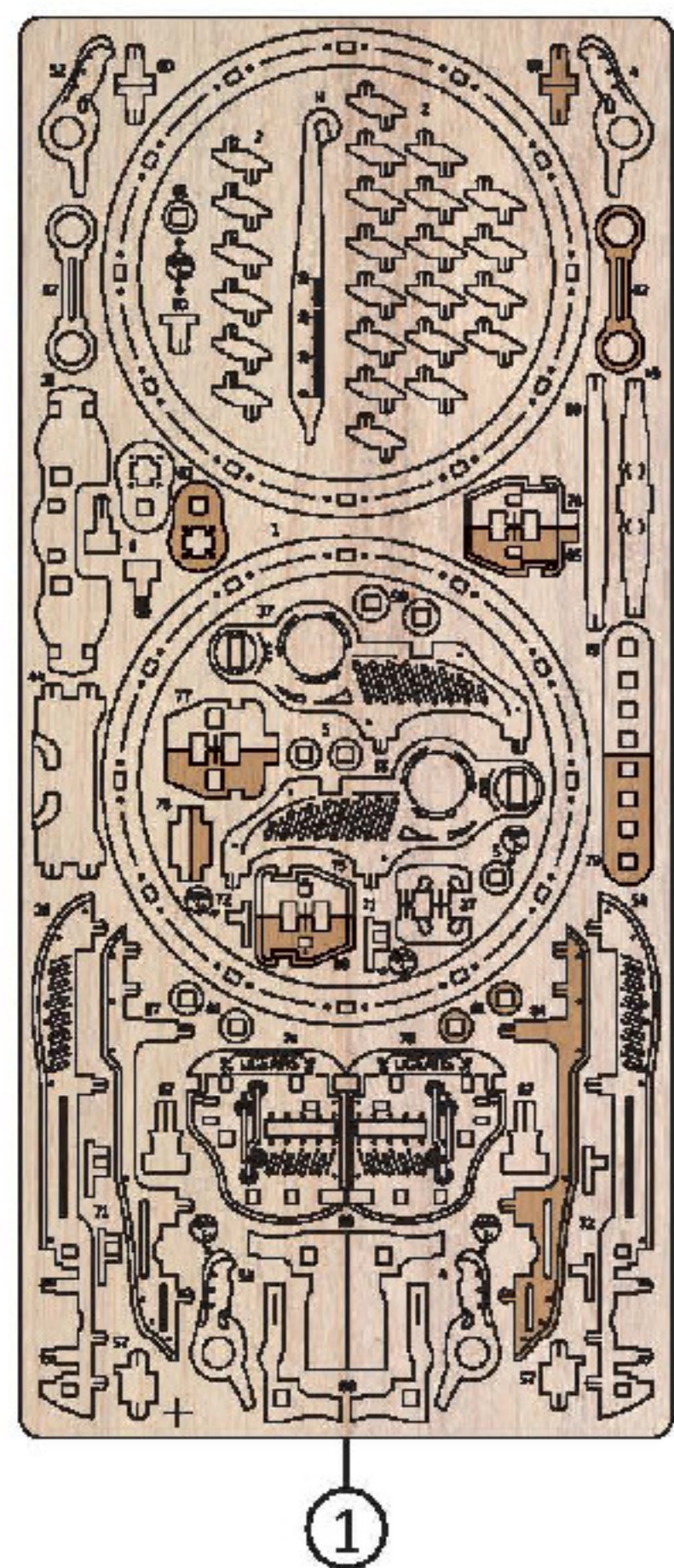
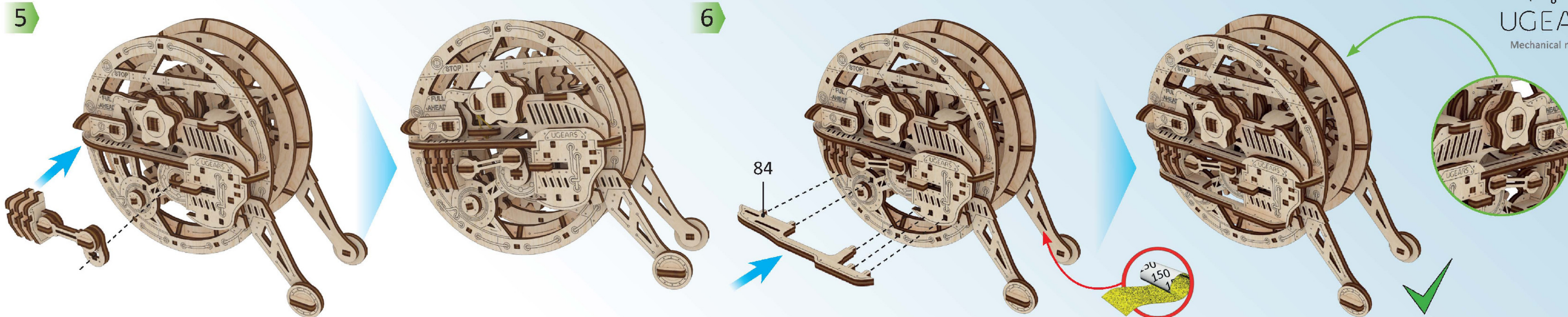

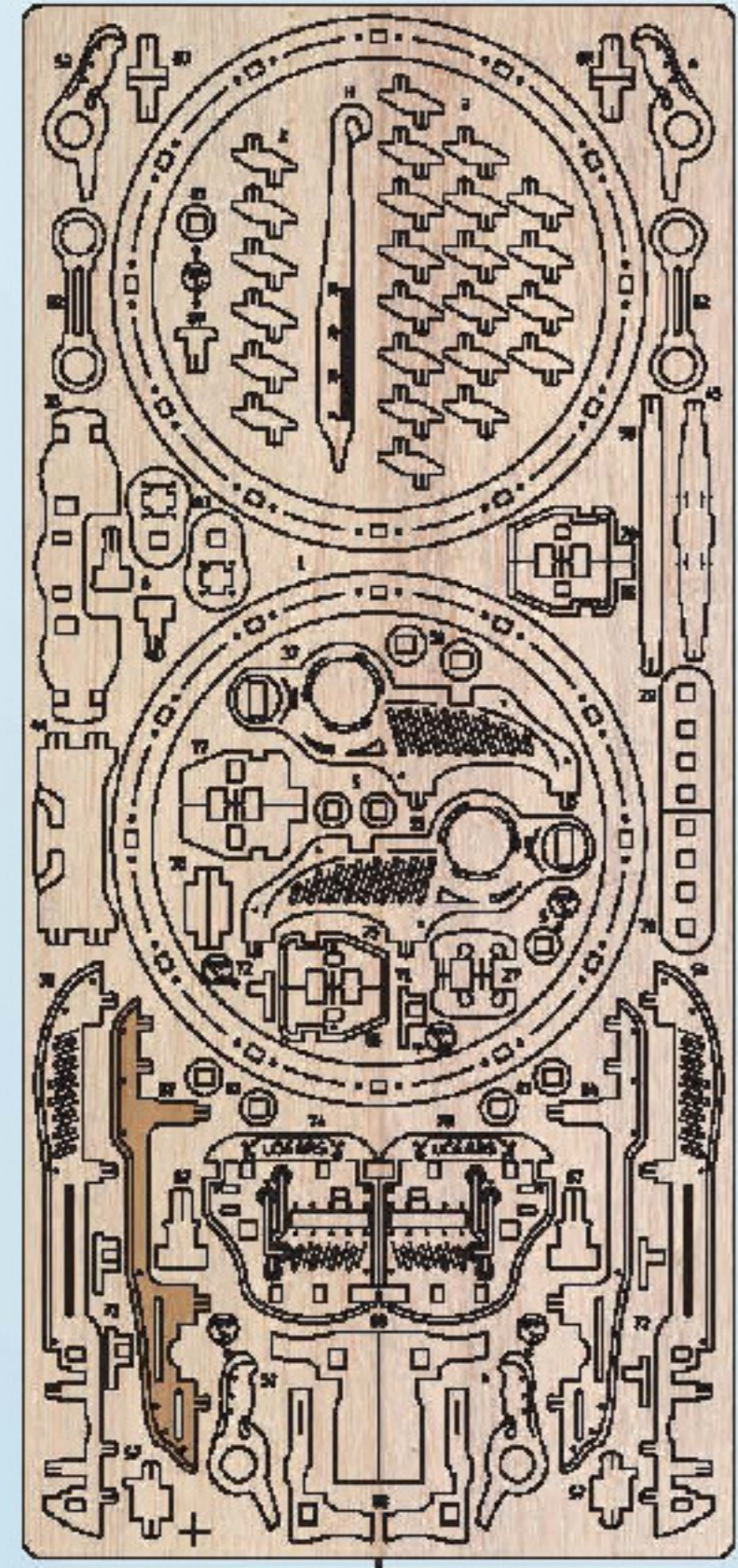

1

5

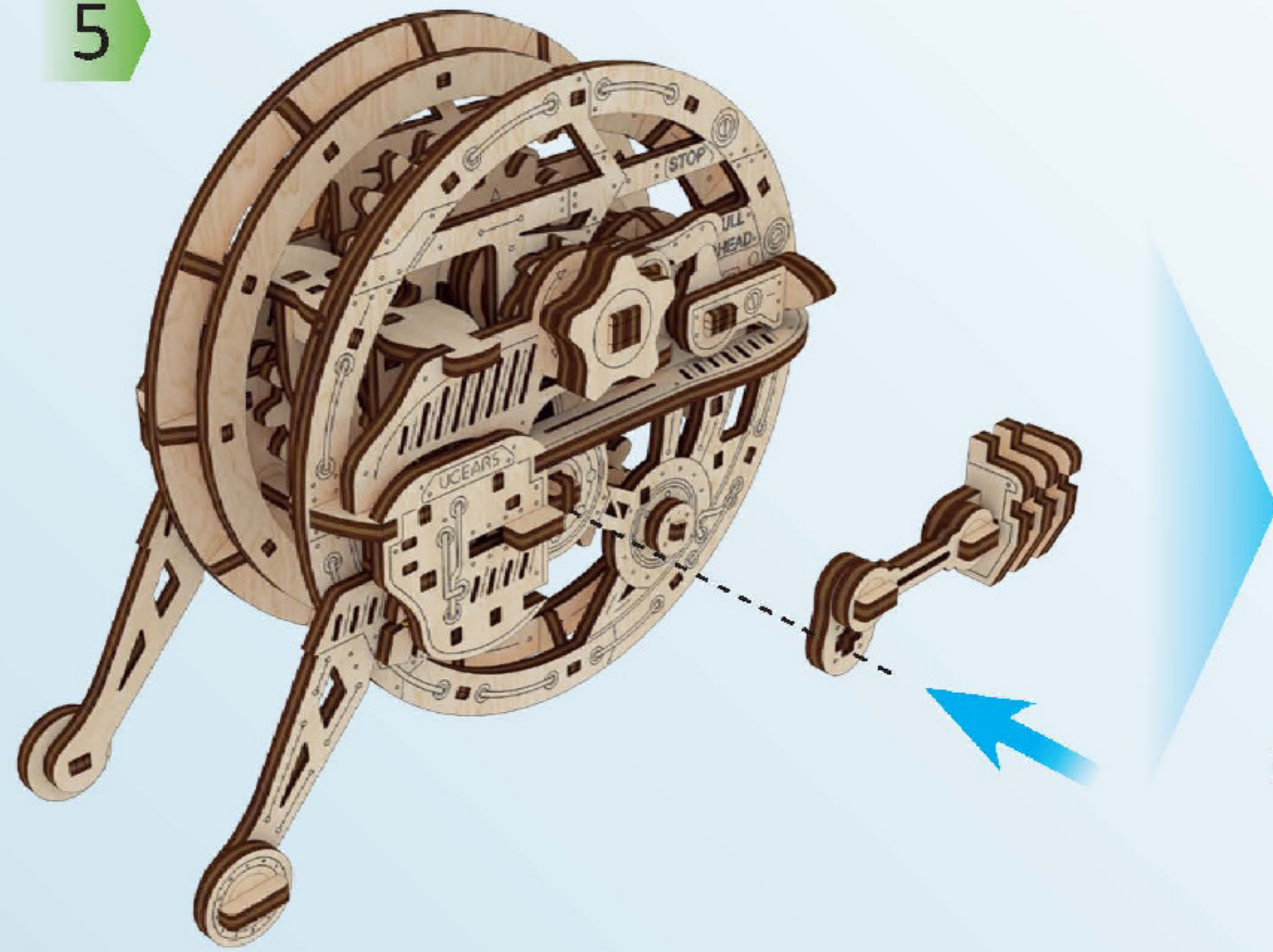

6

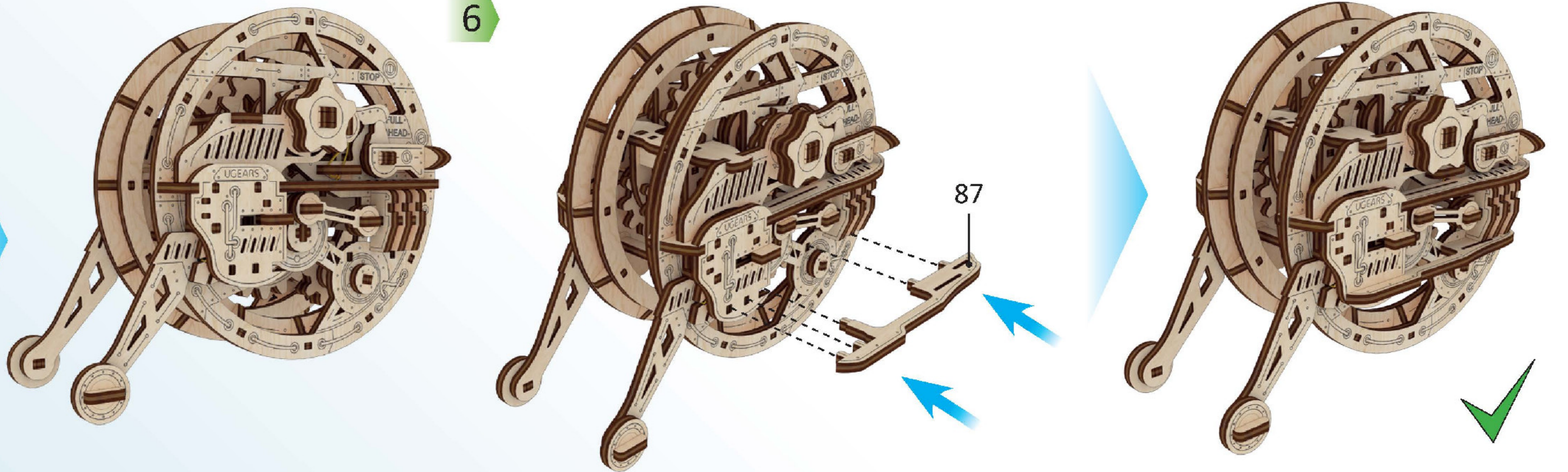

7

x2

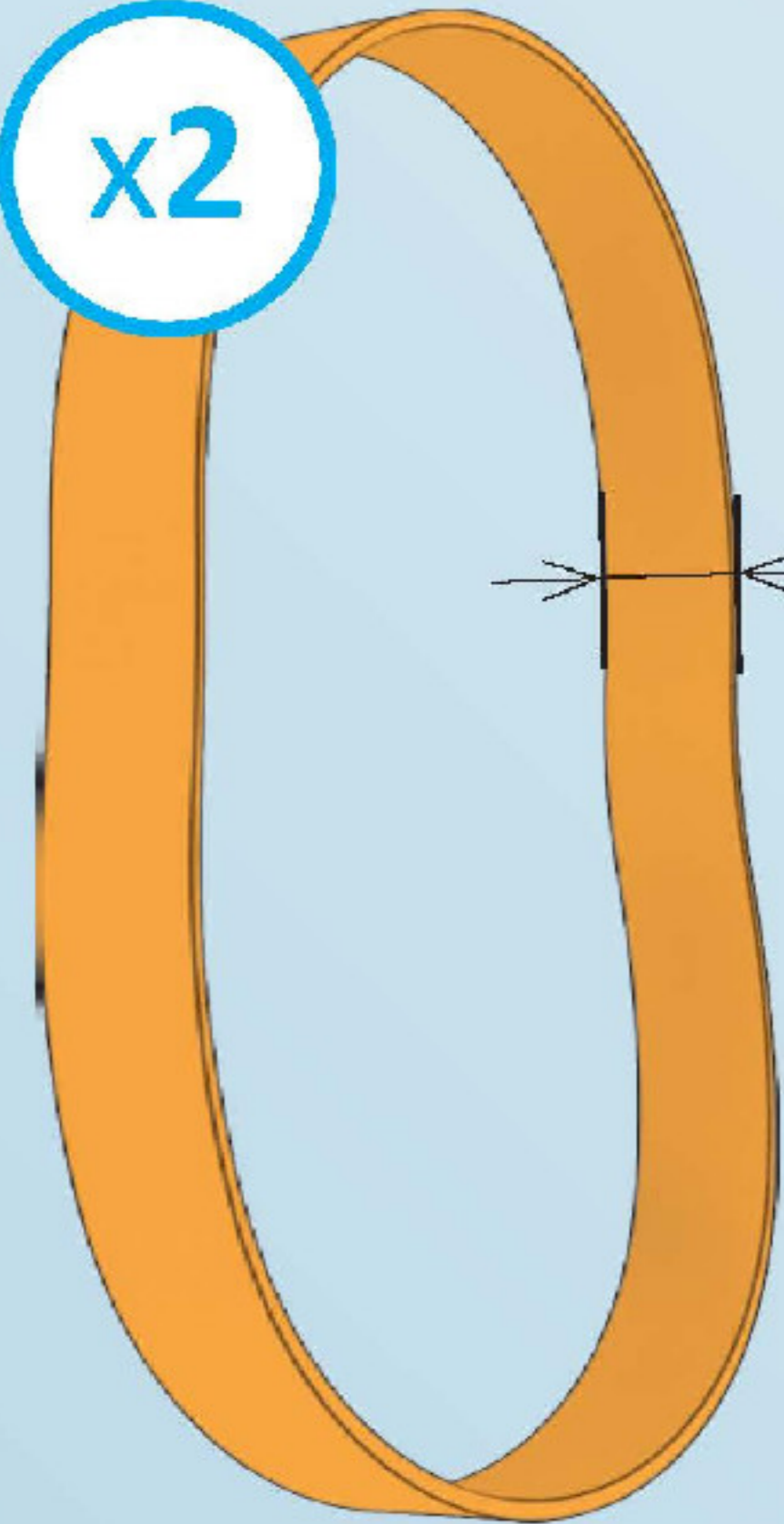

5mm/0.19"

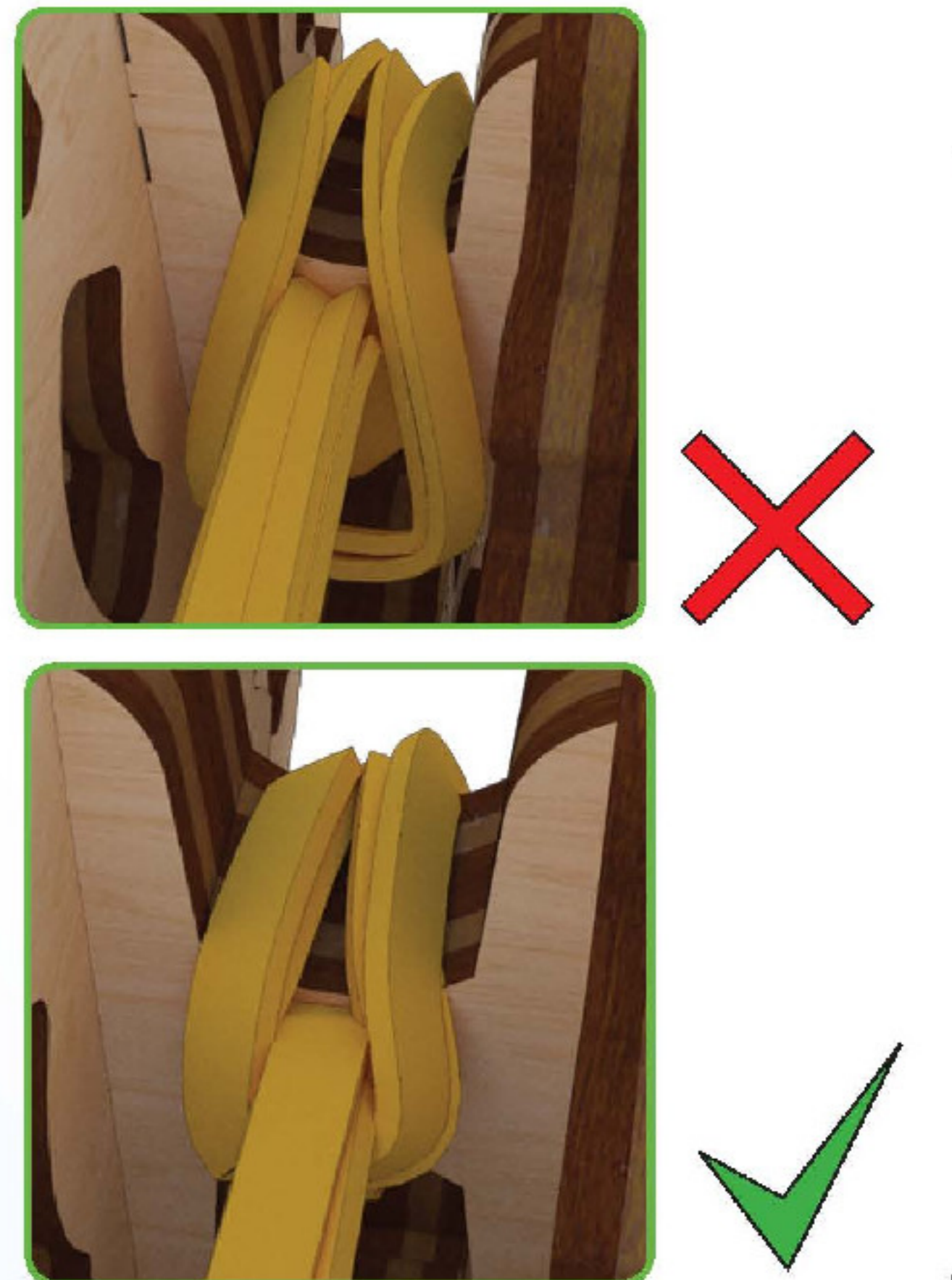
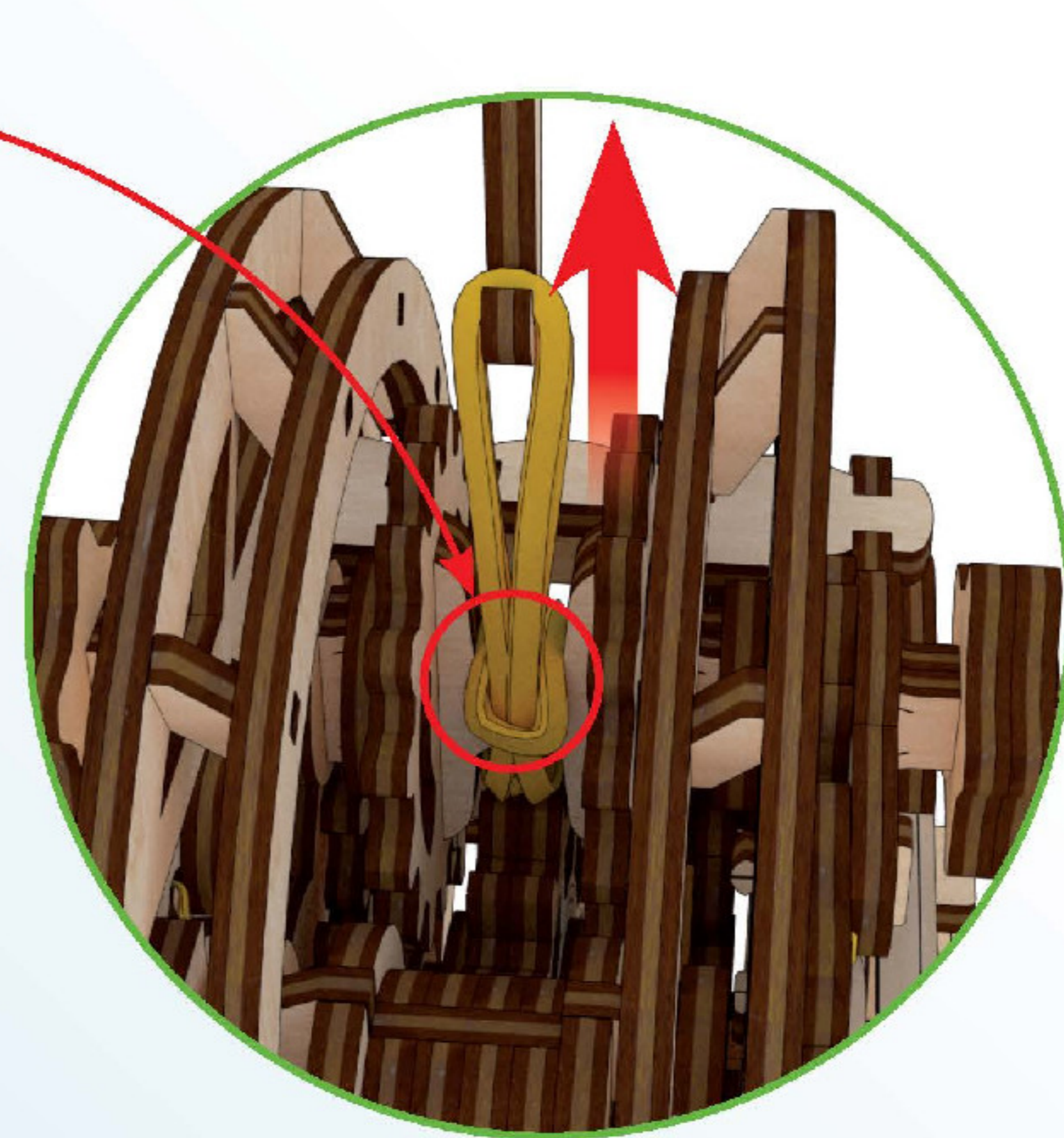
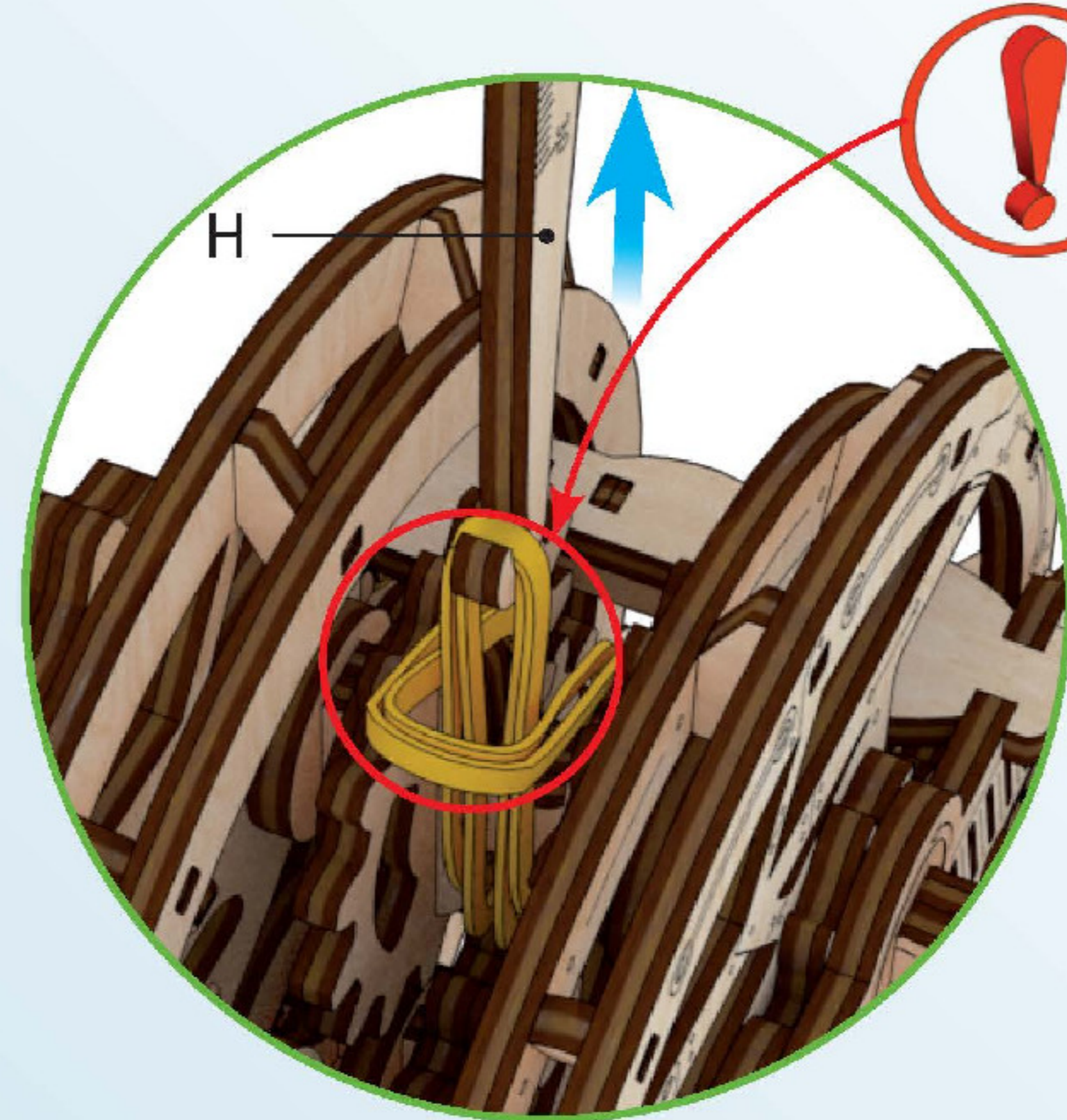
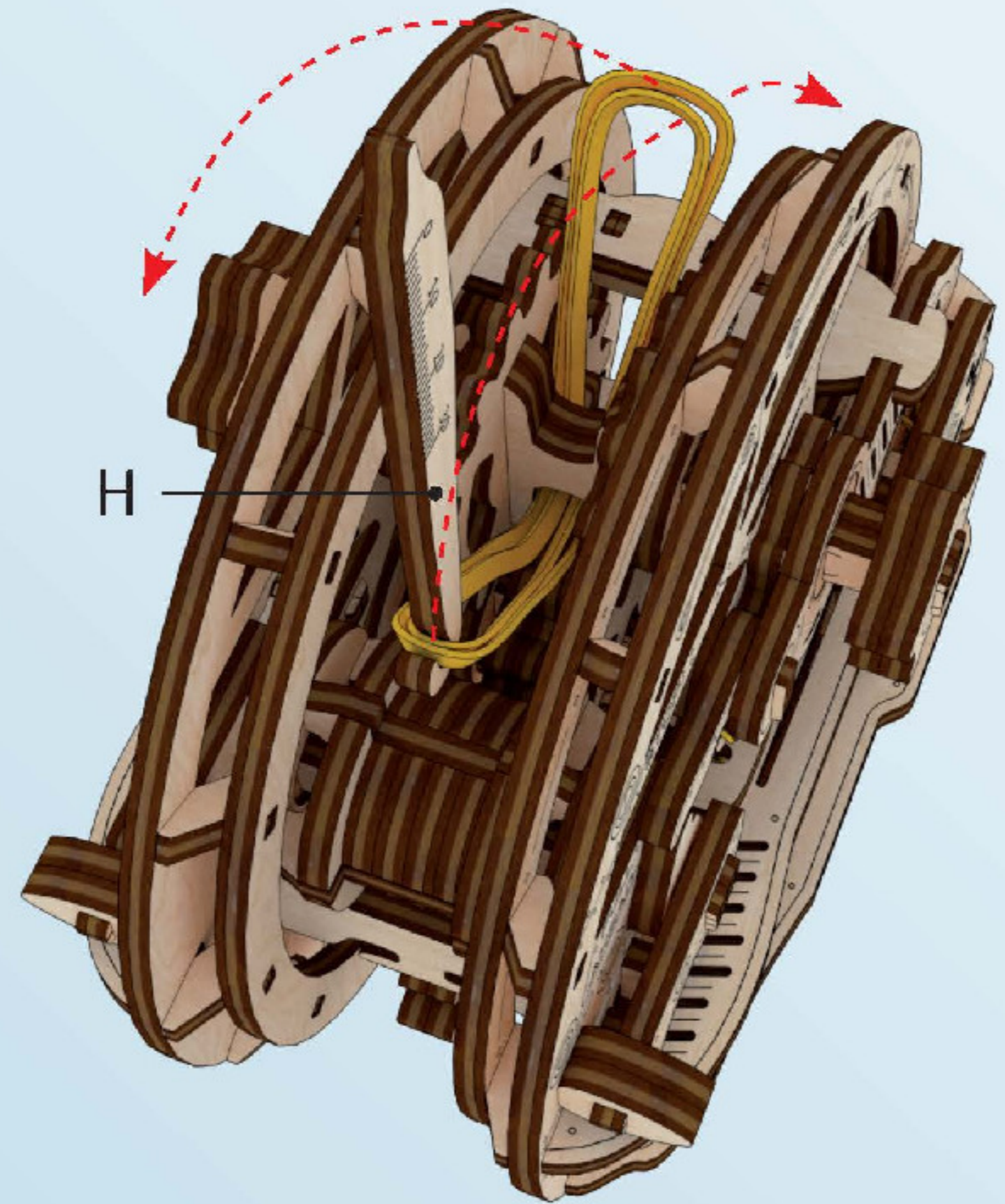
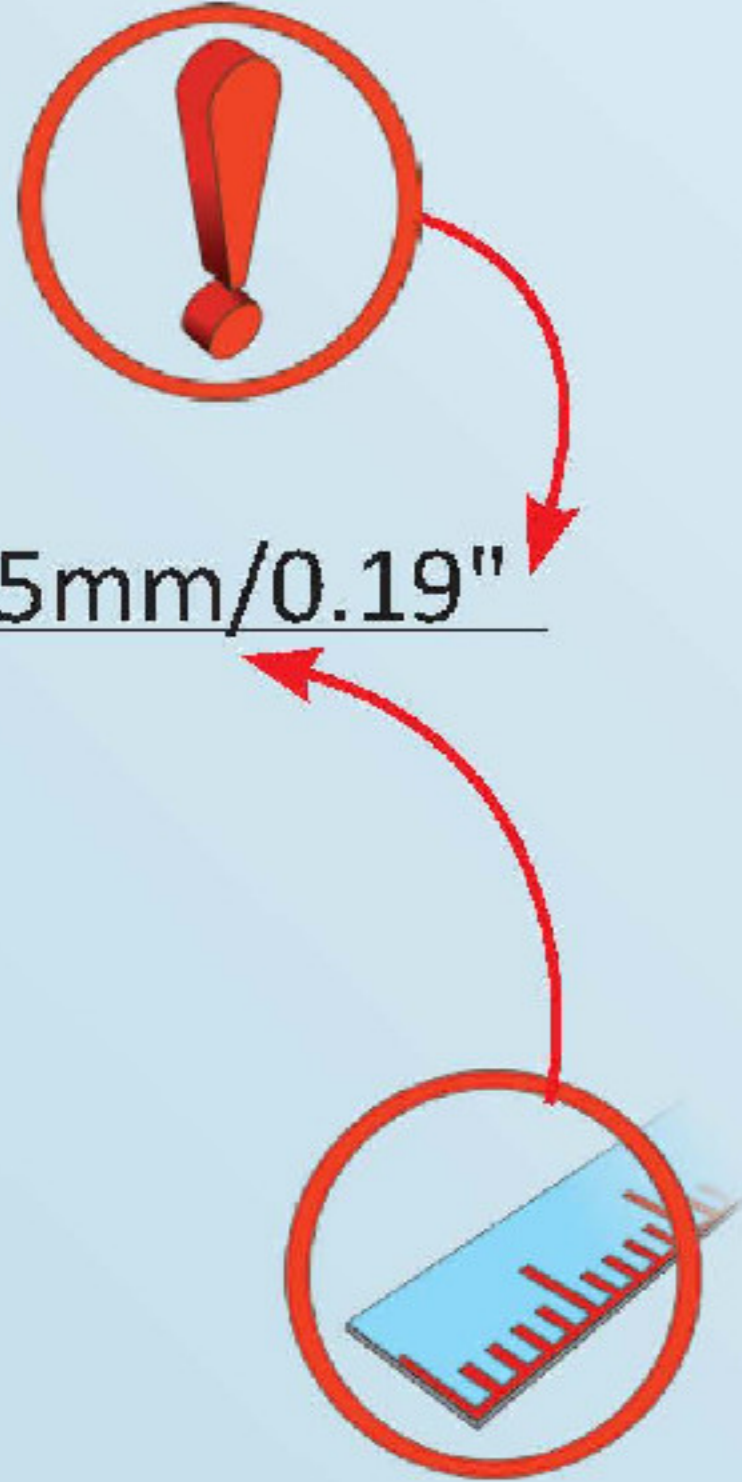

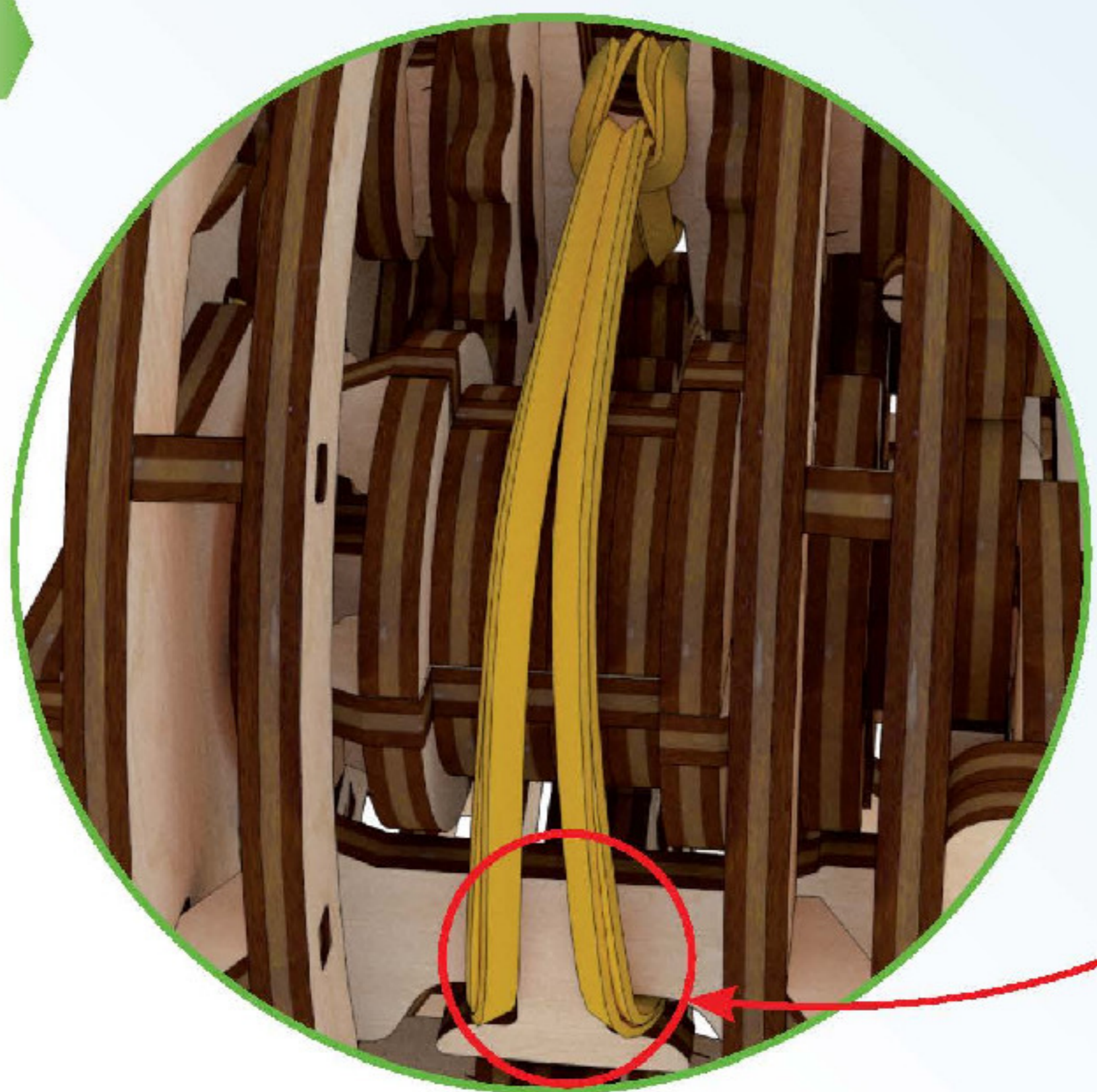
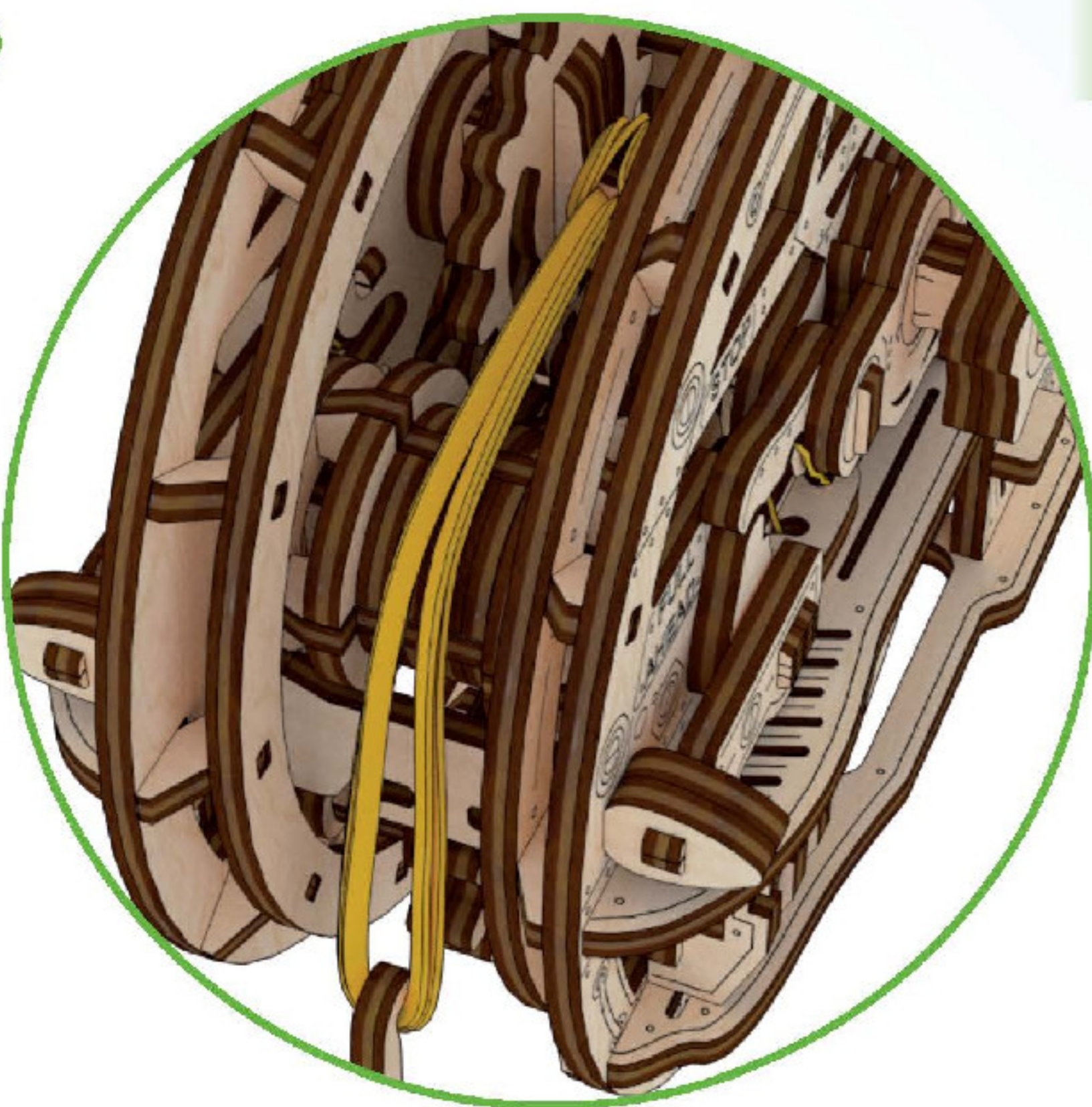
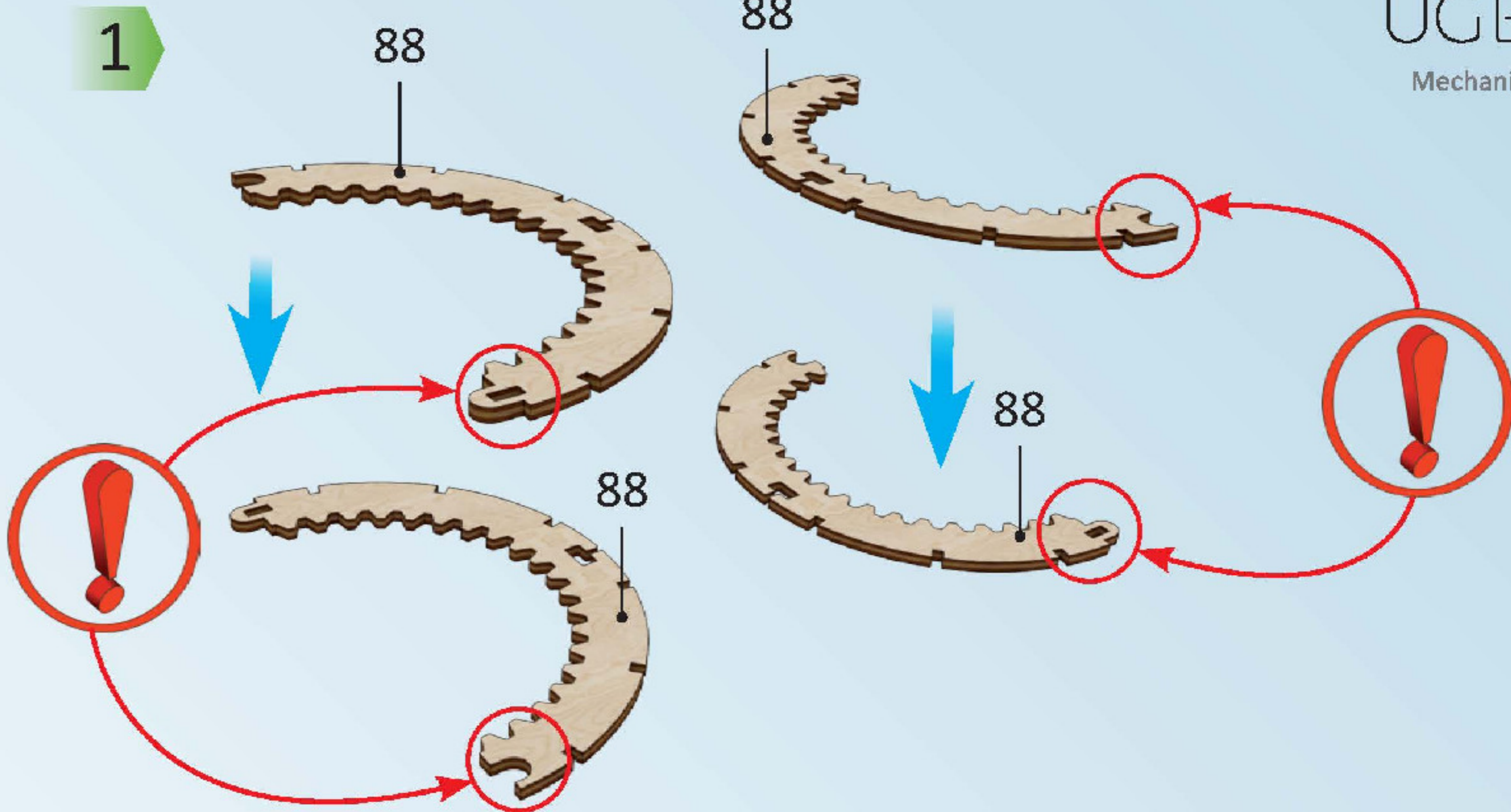
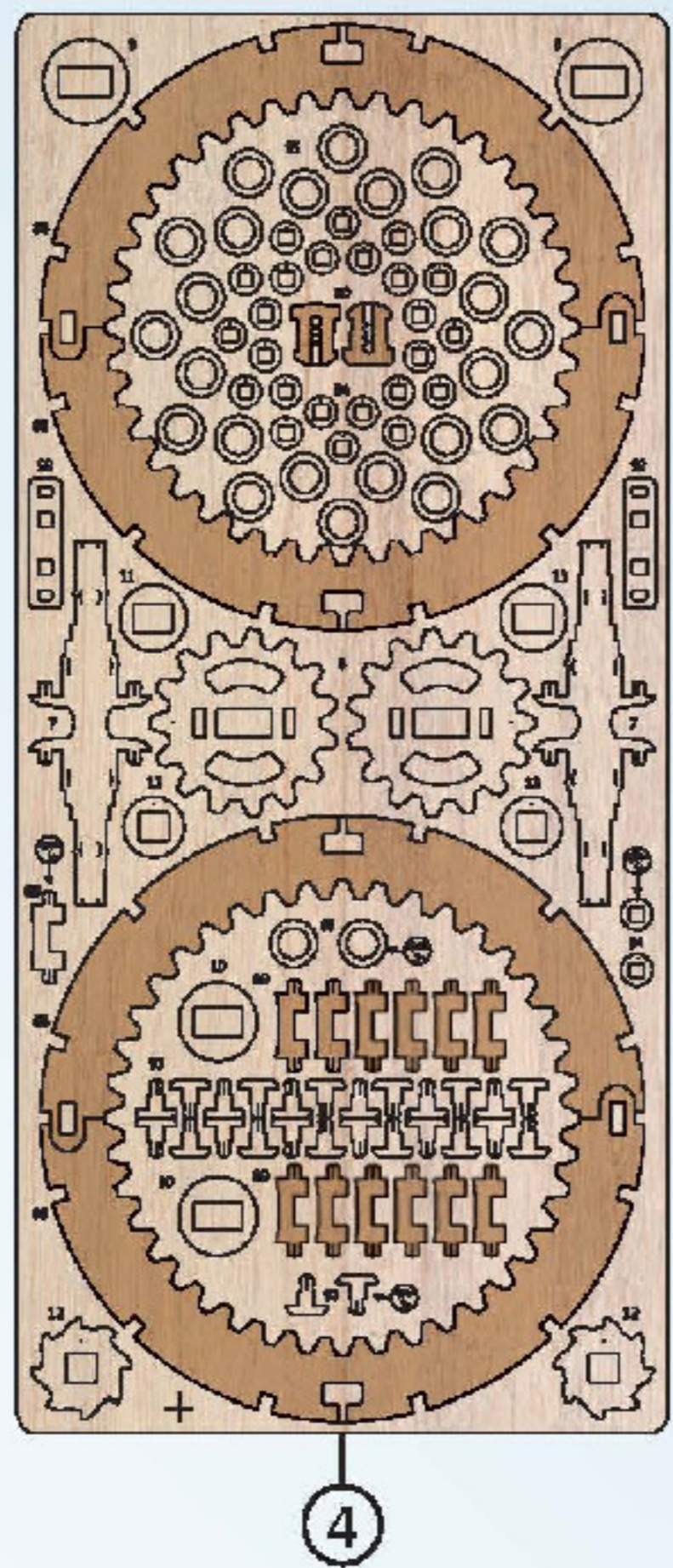

8

9

2

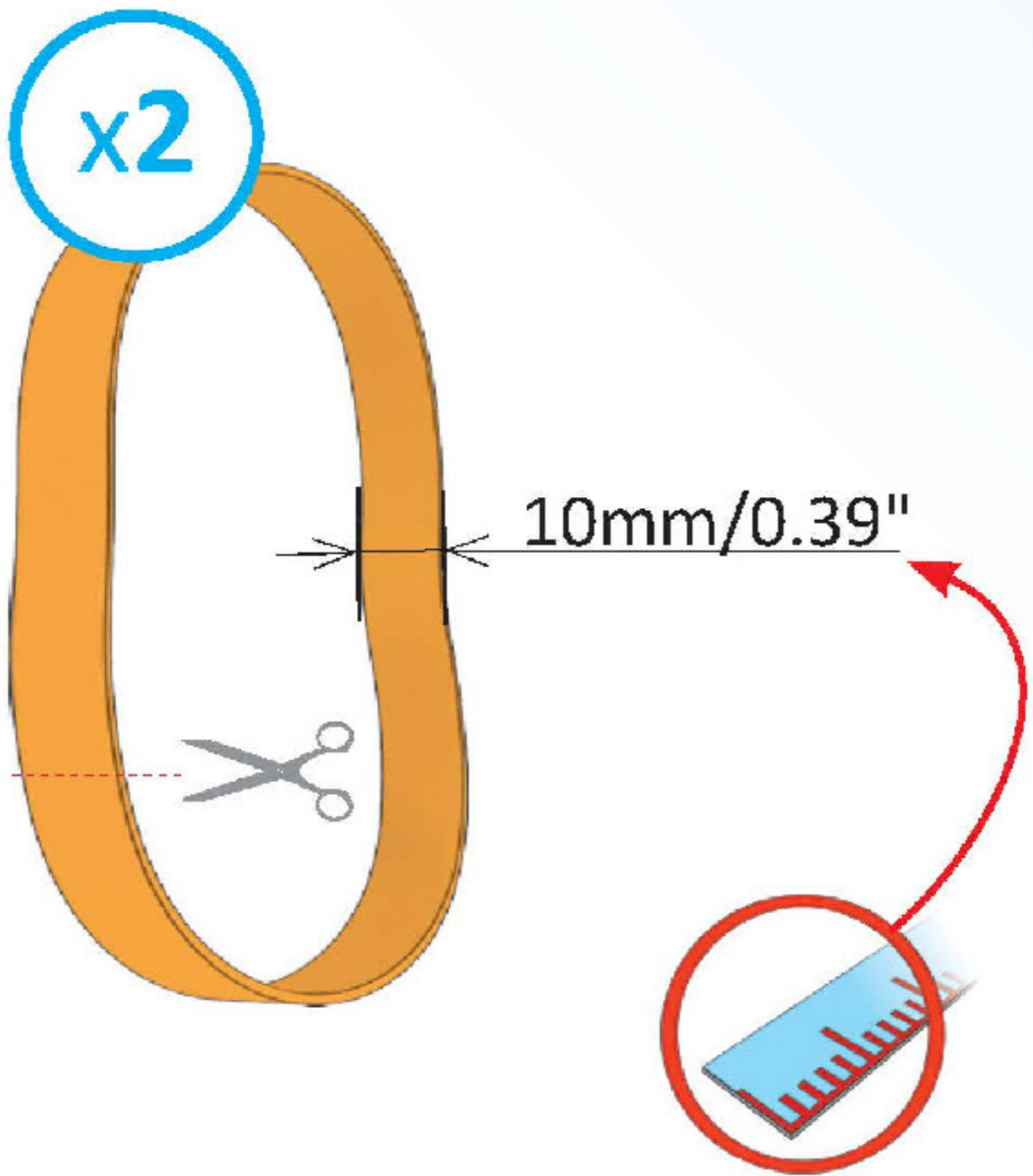
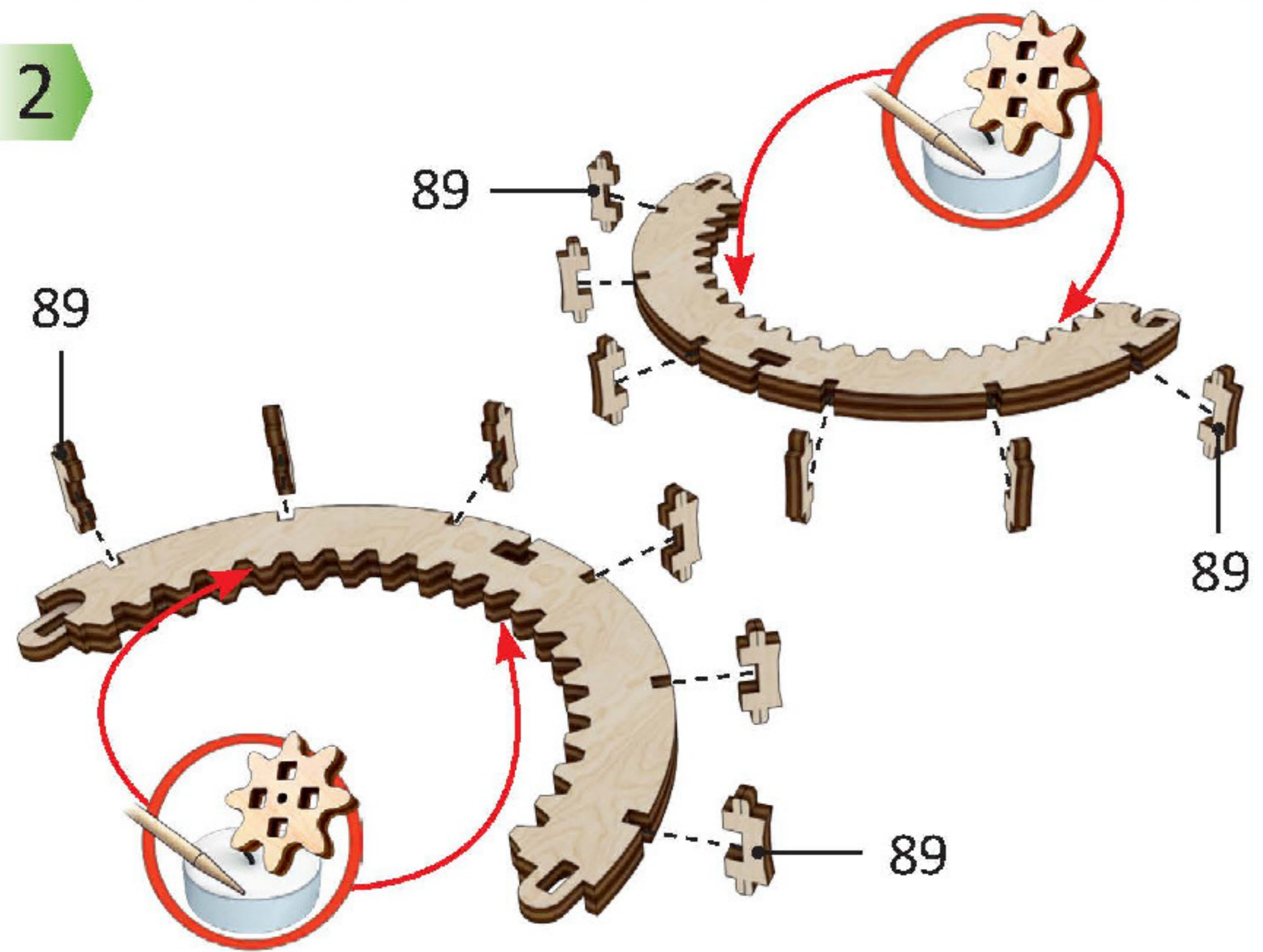

3

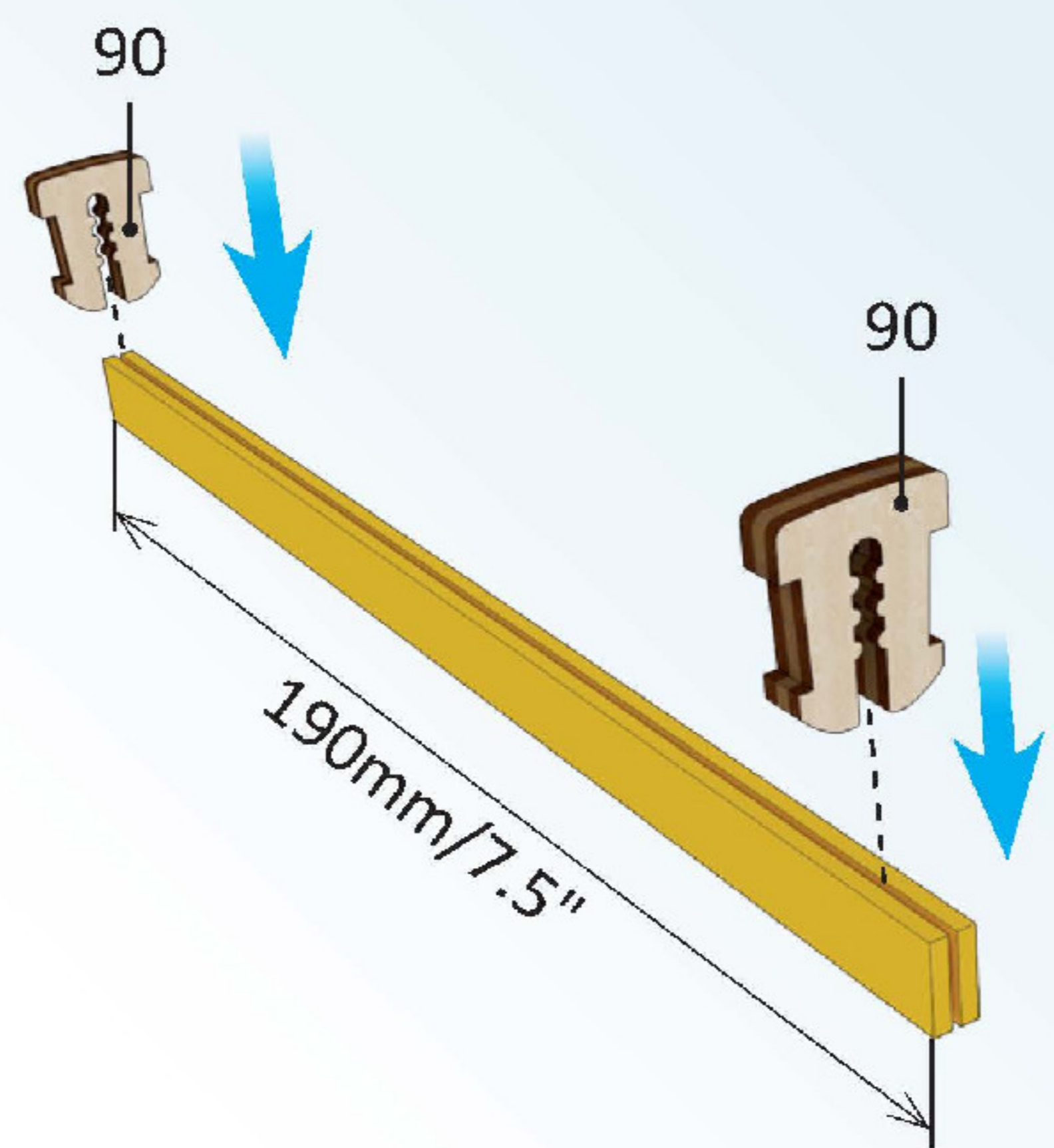

4

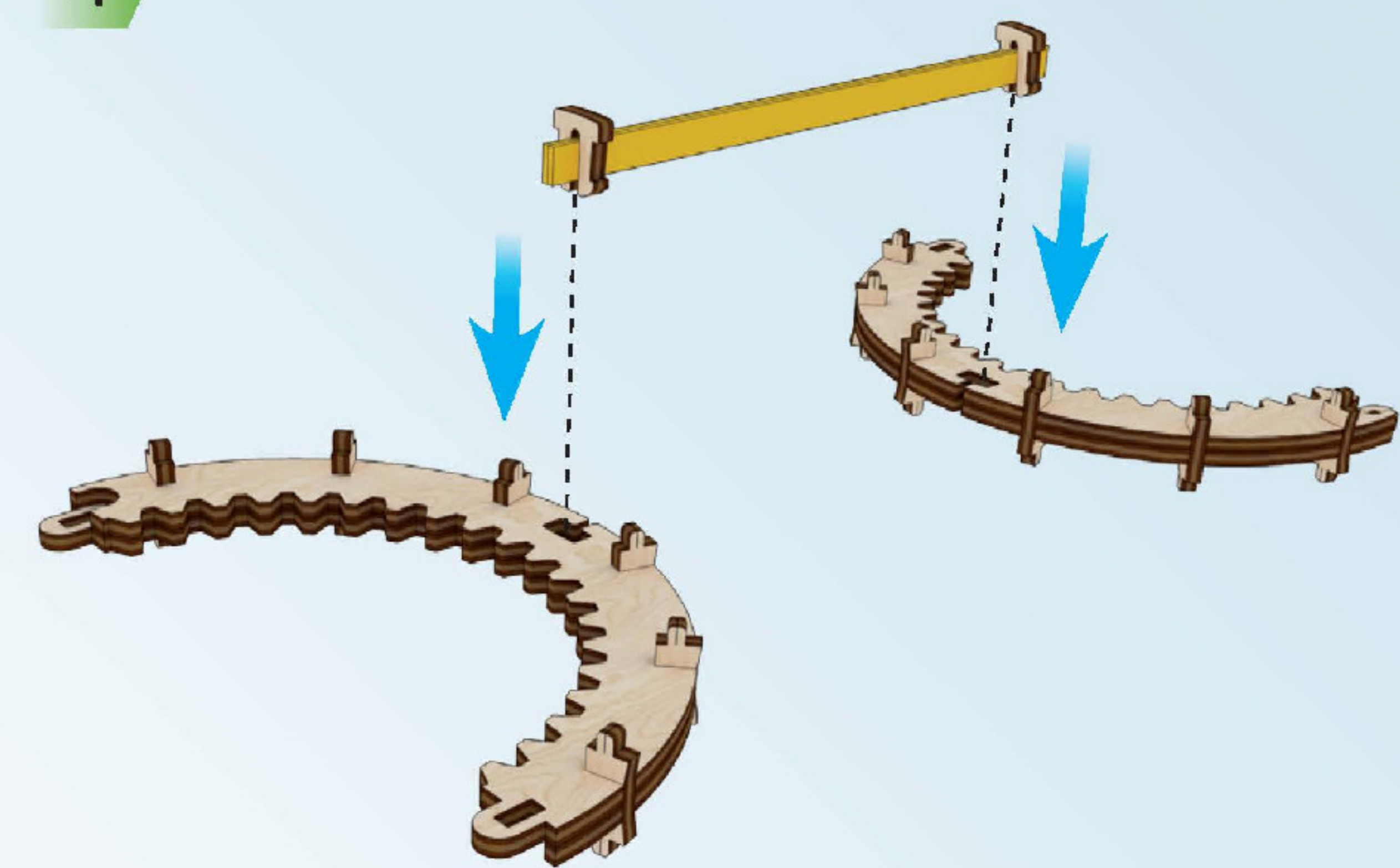

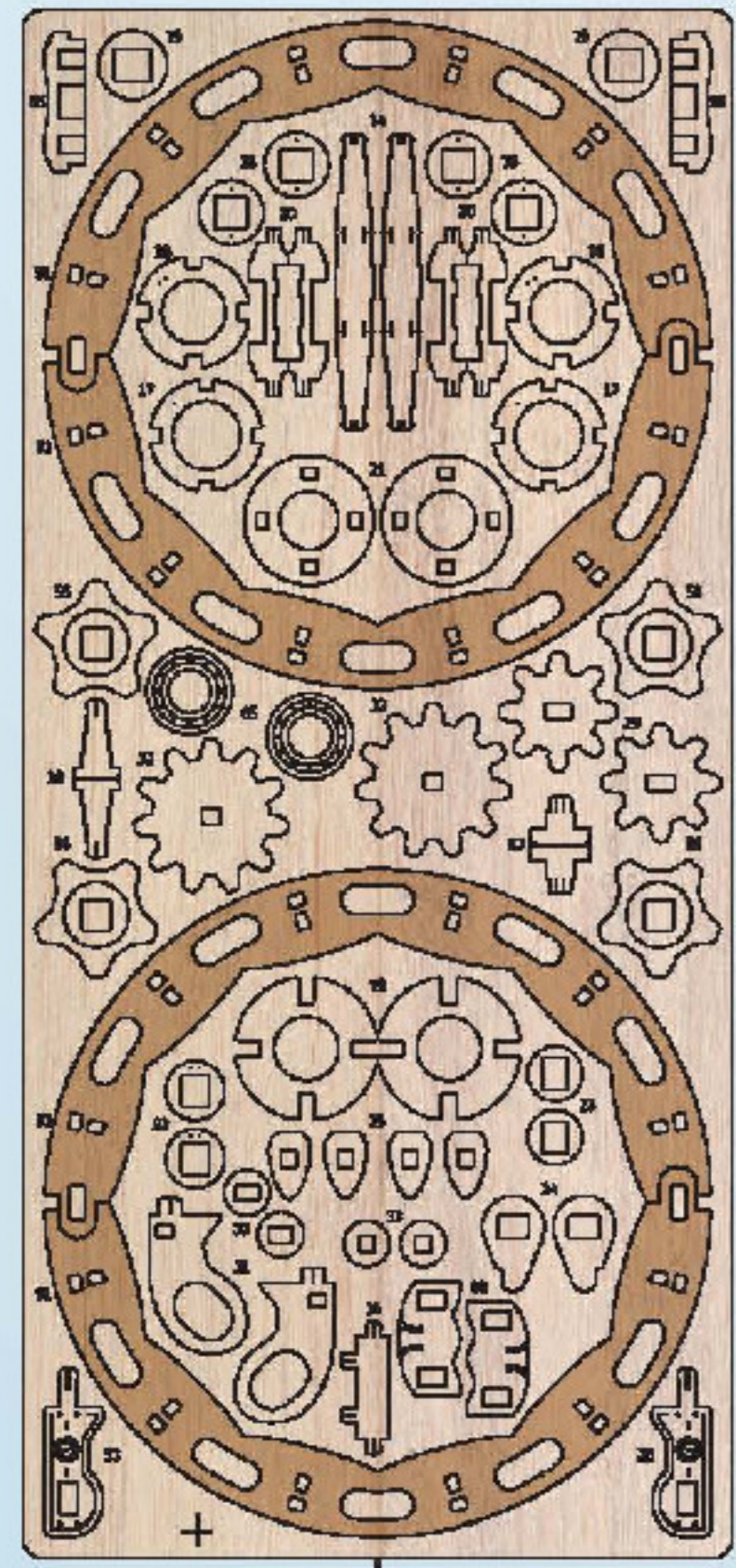

2

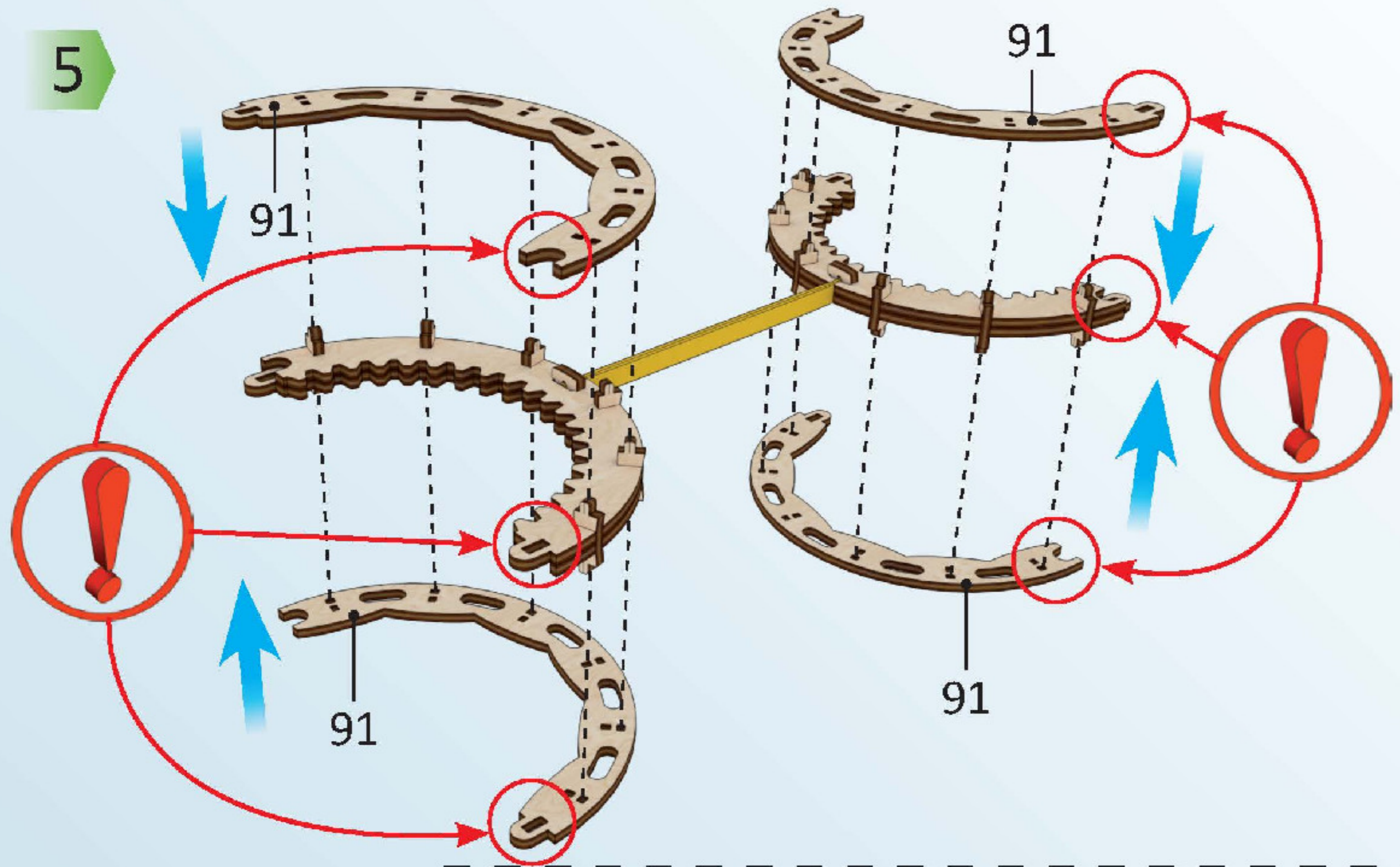

6

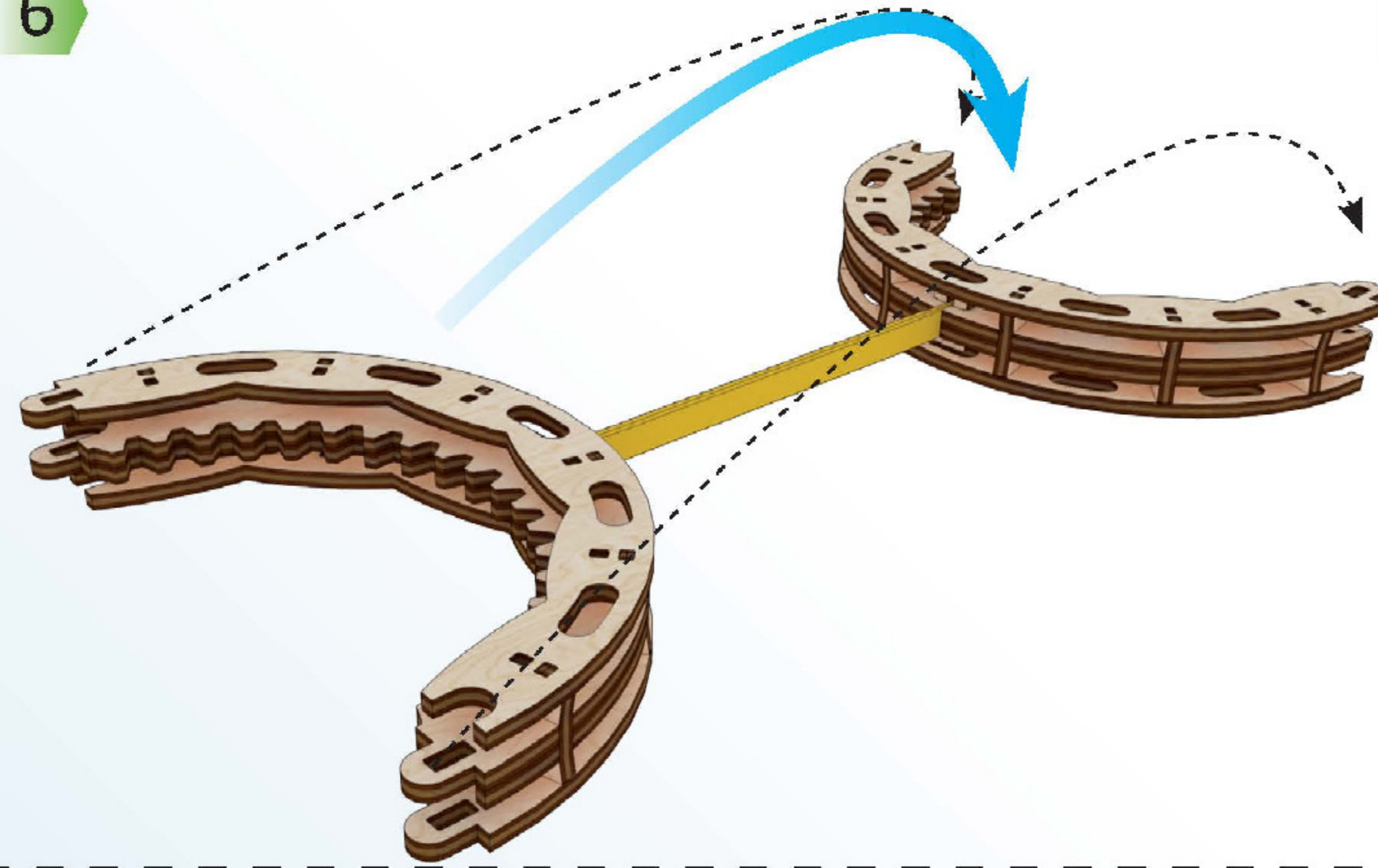

7

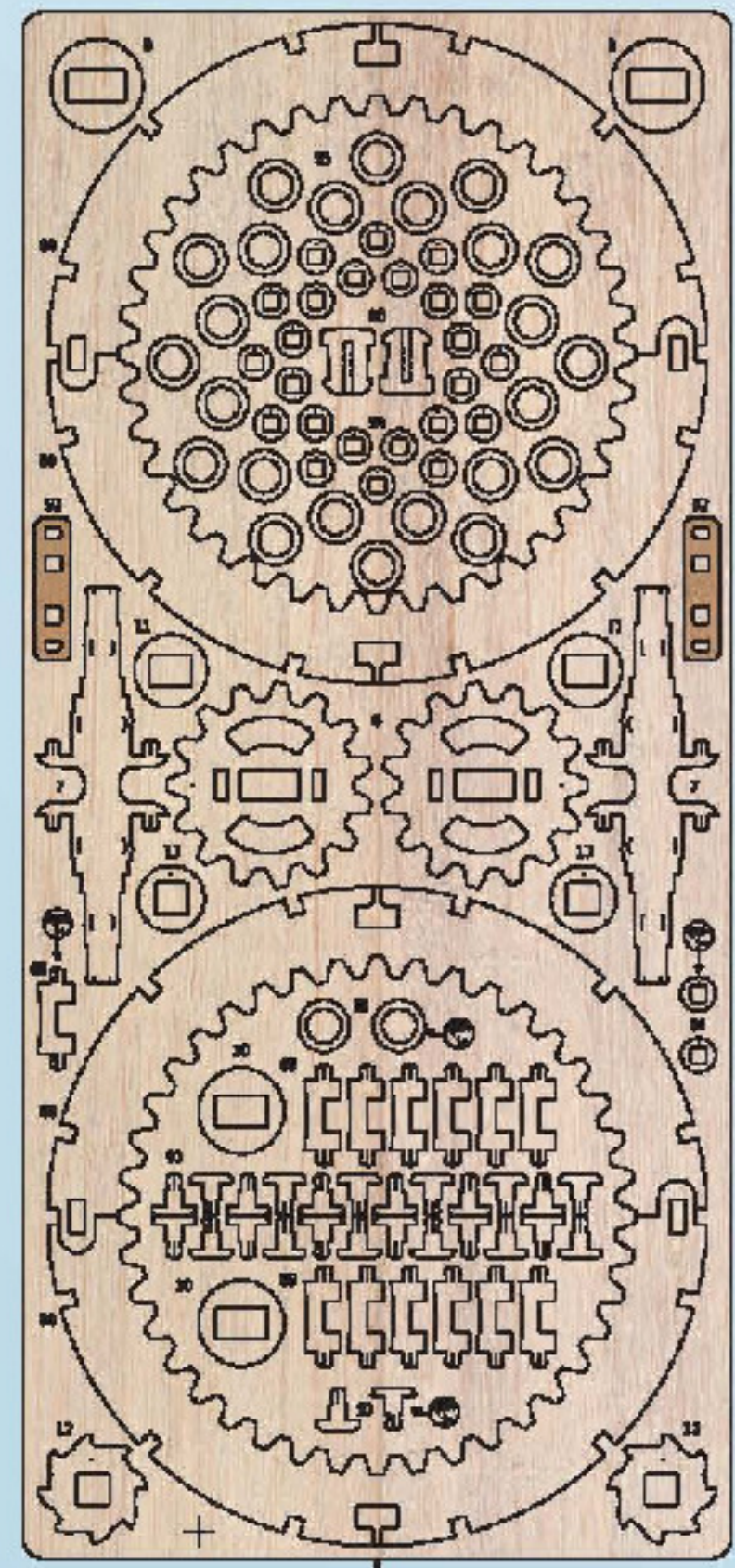
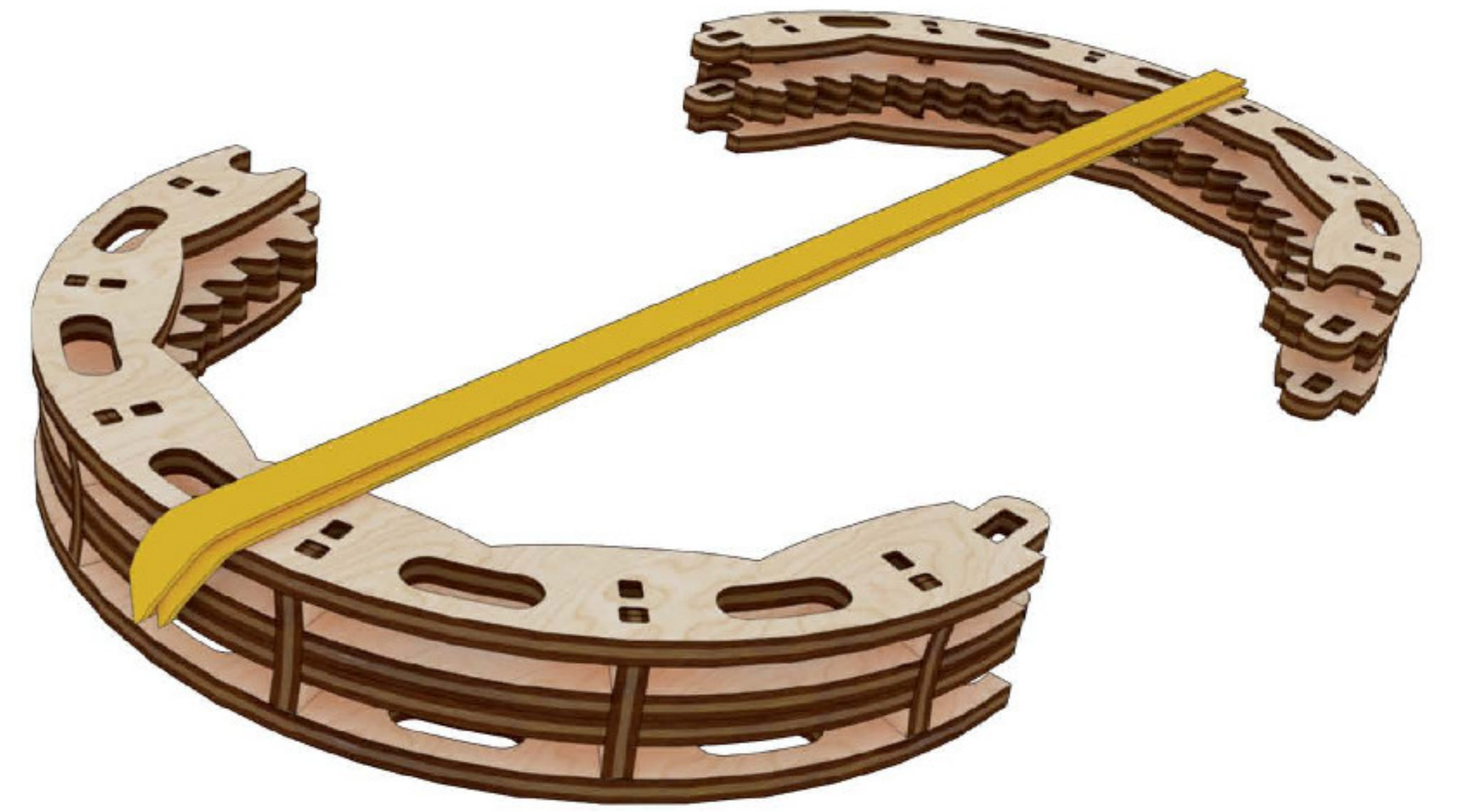

4

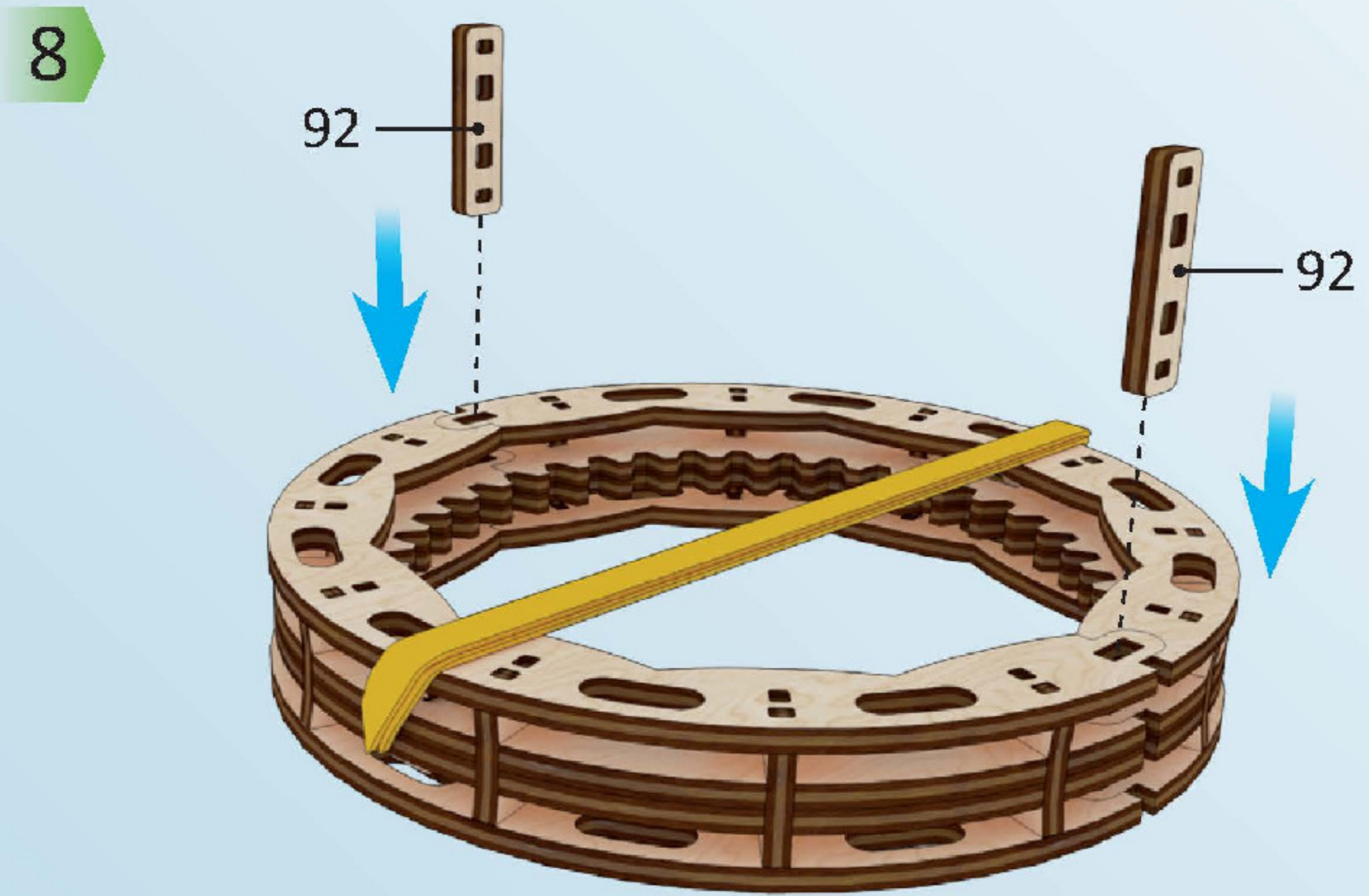

9

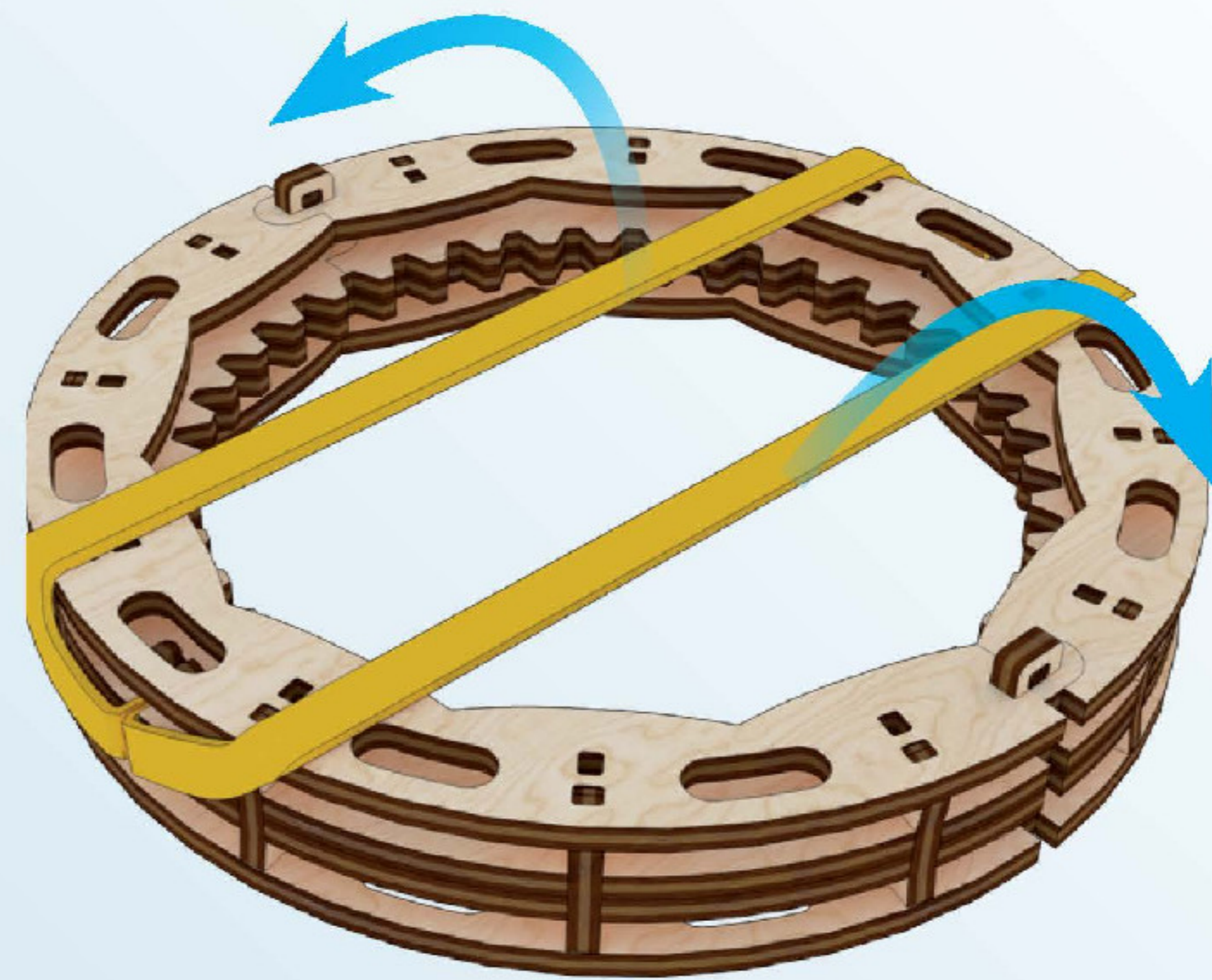

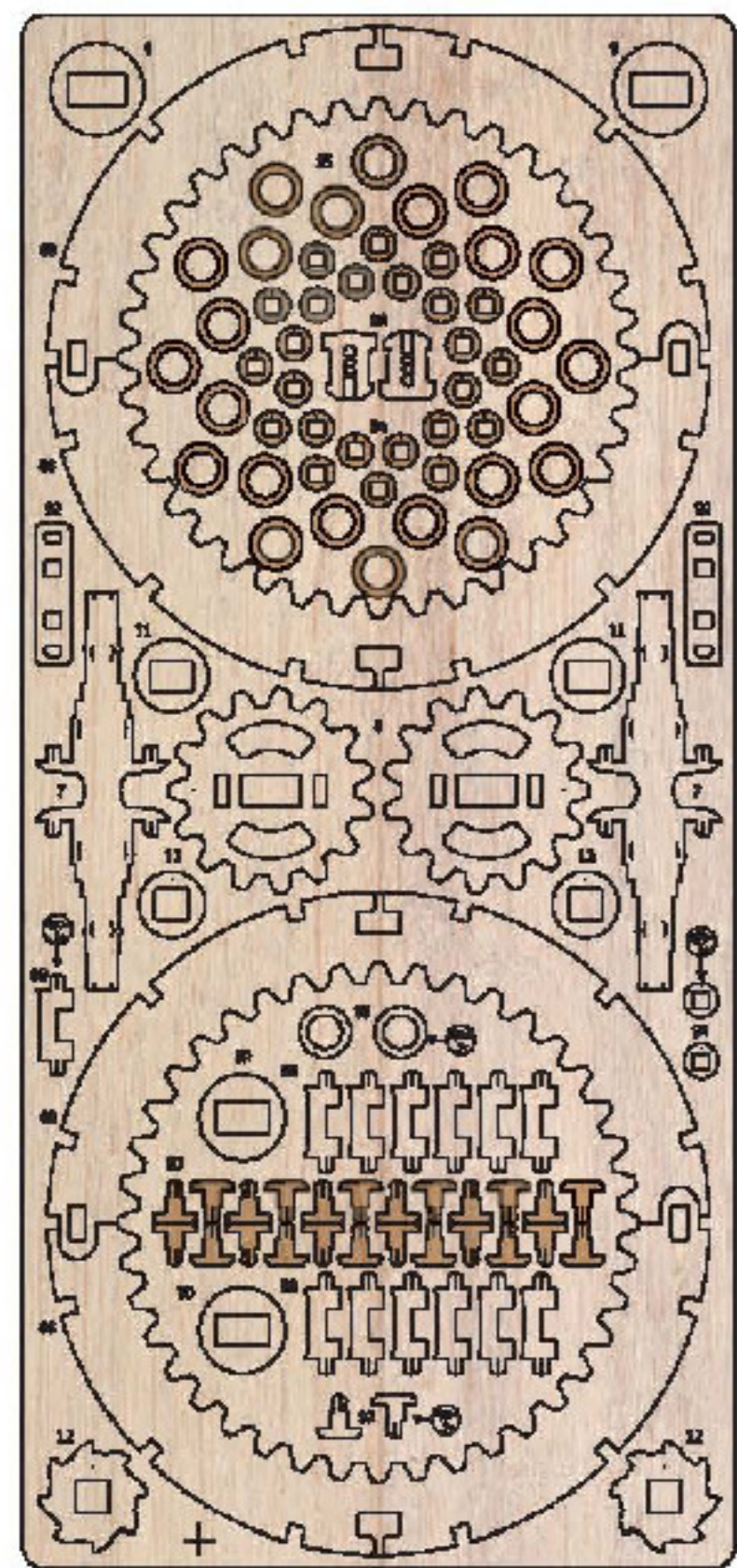

1

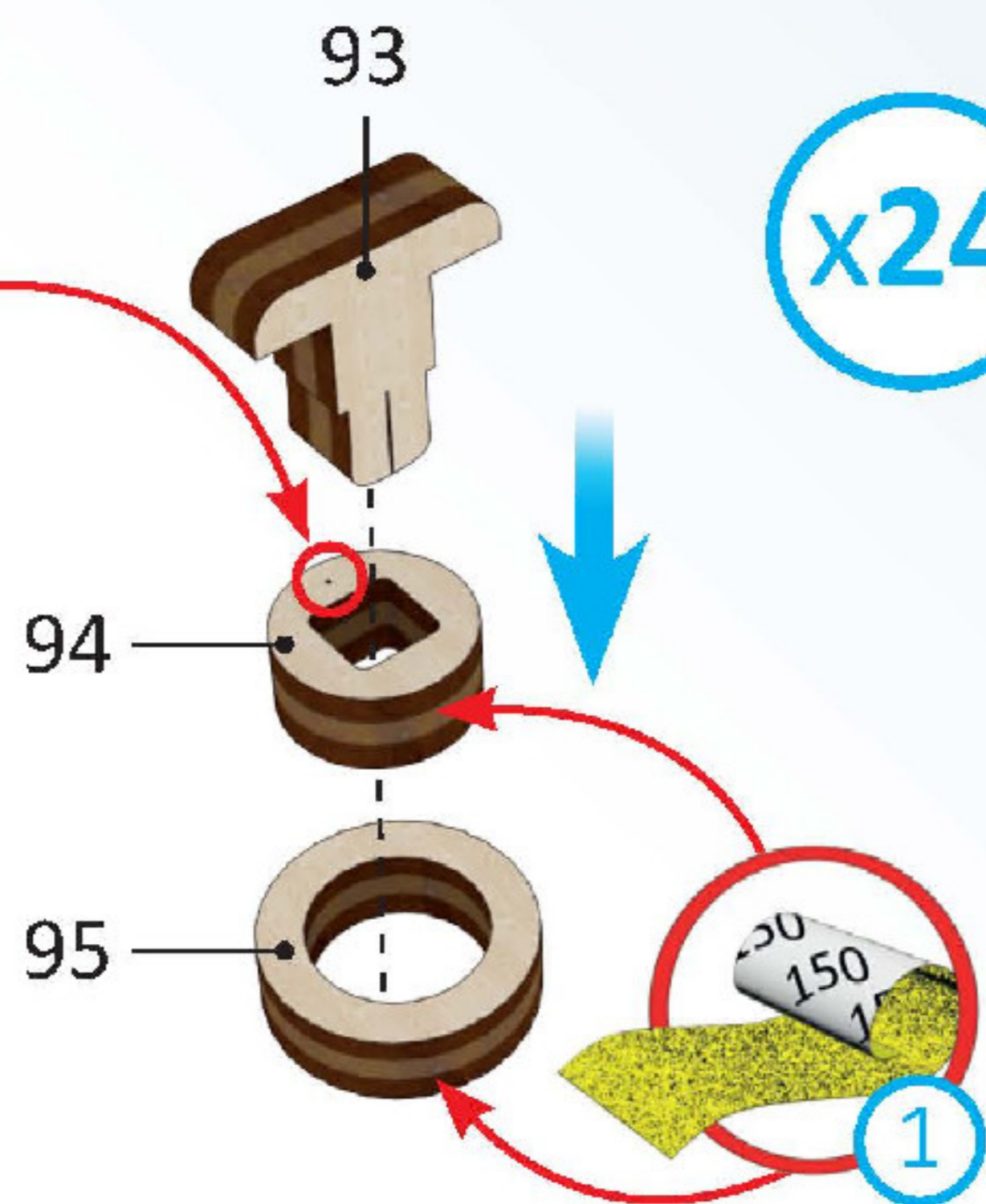

2

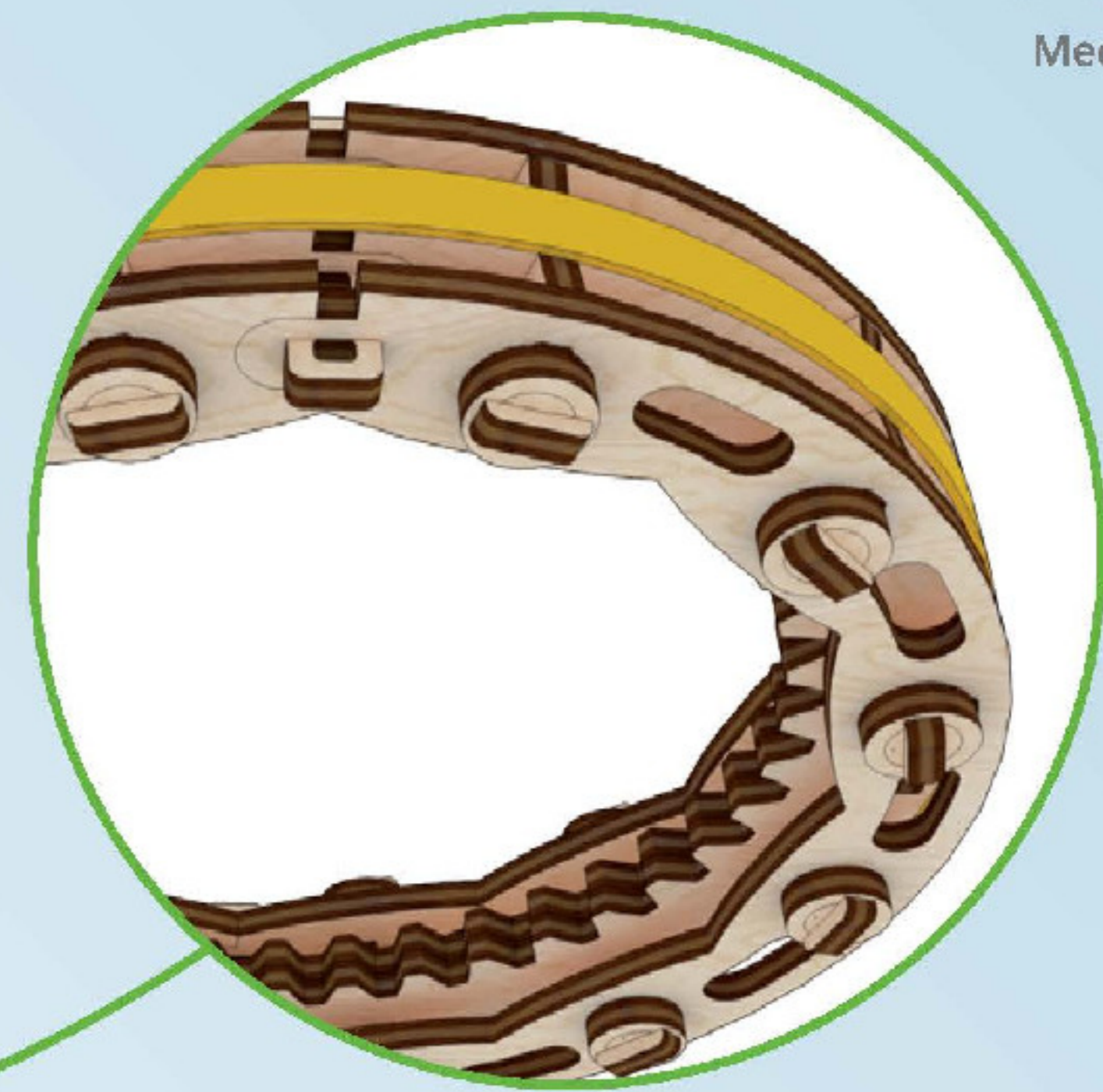
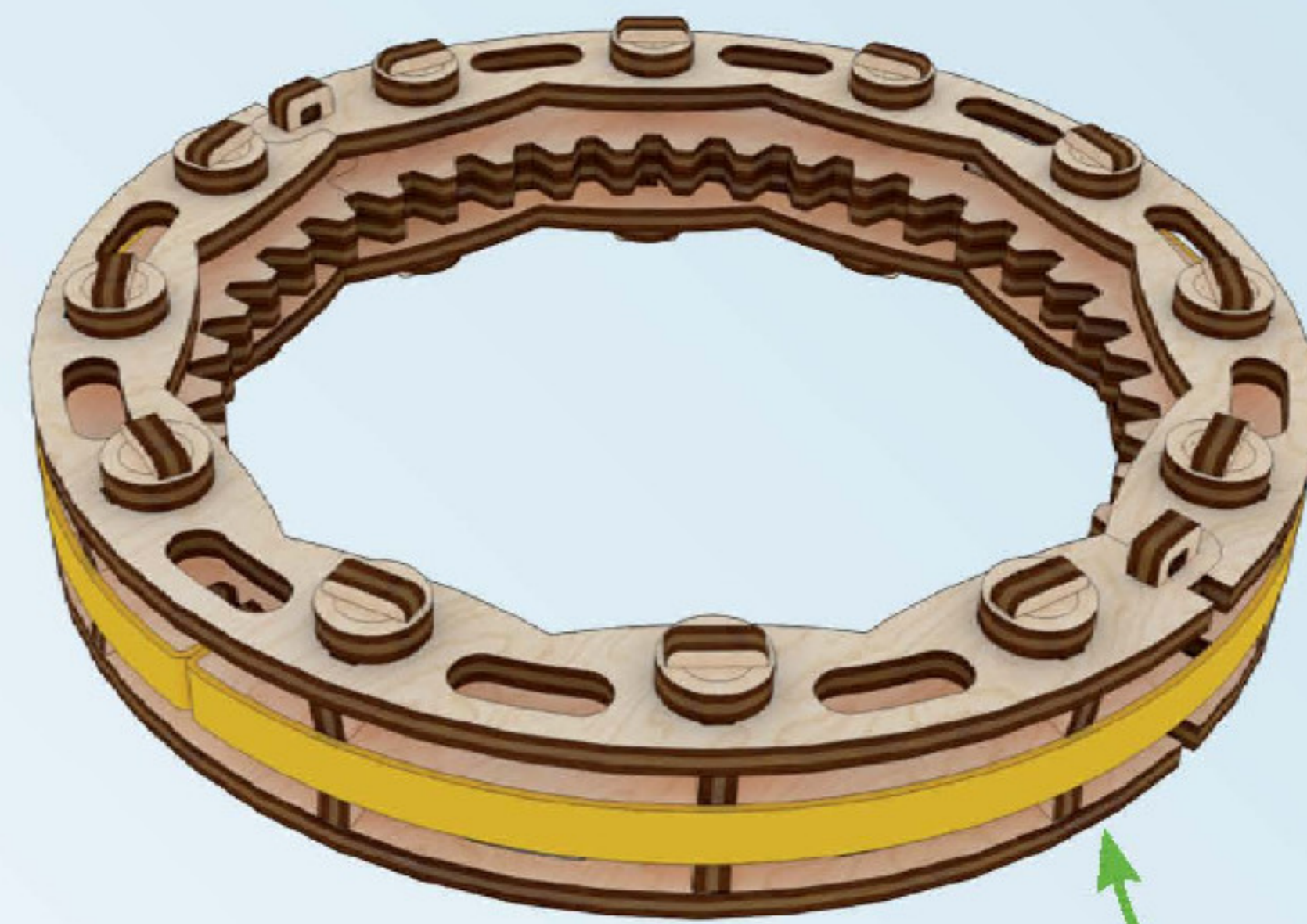
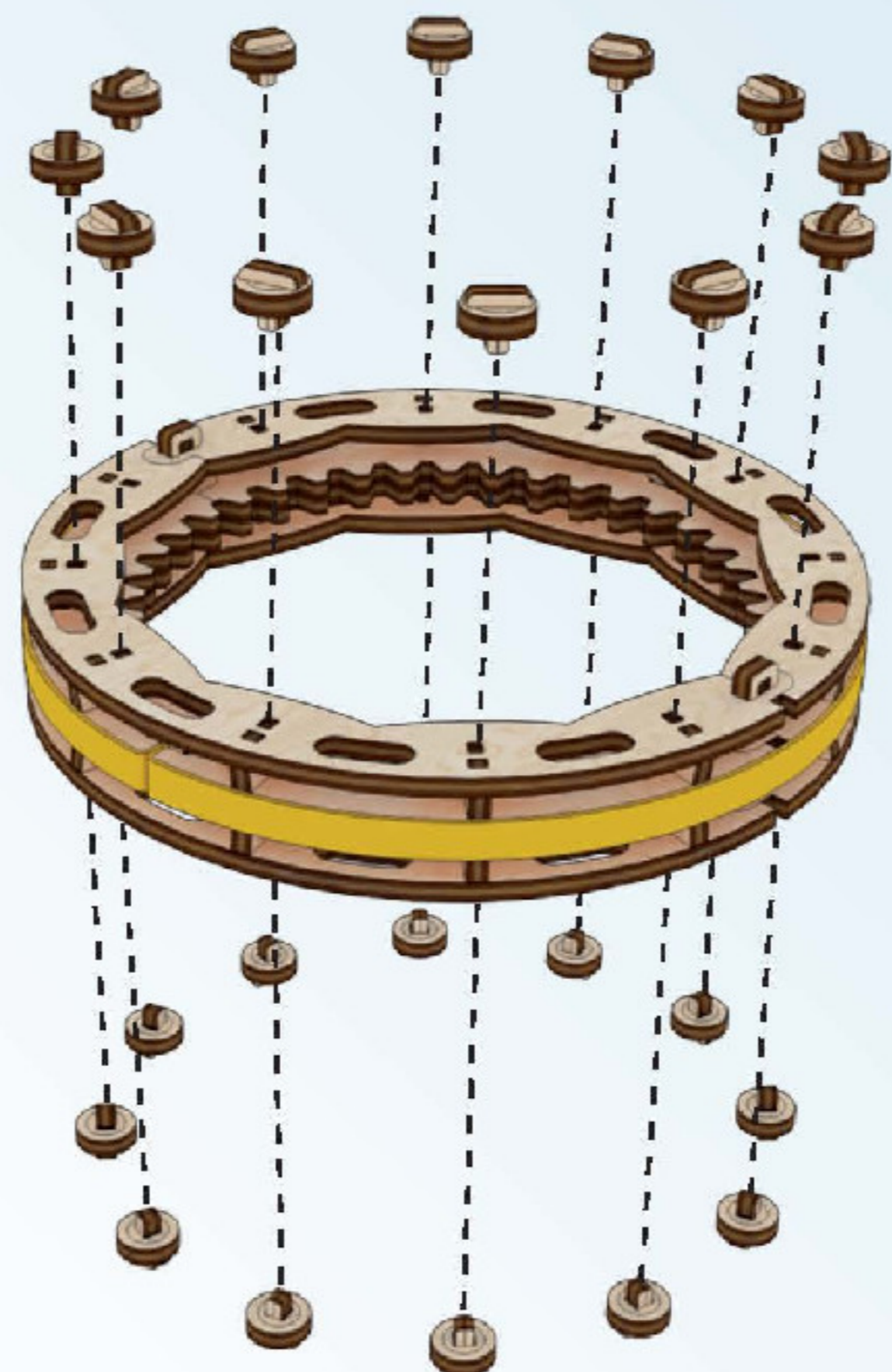

3

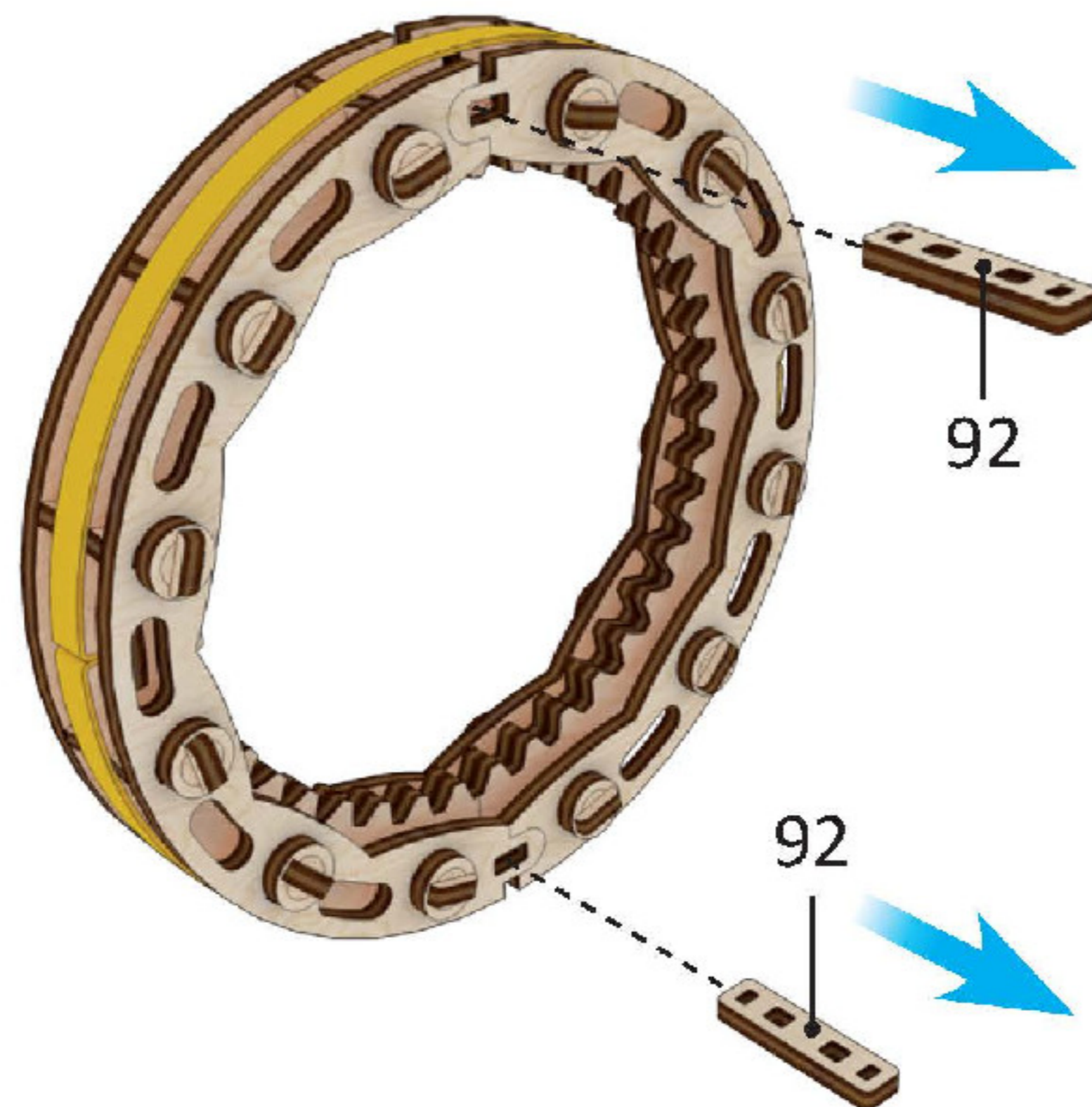

4

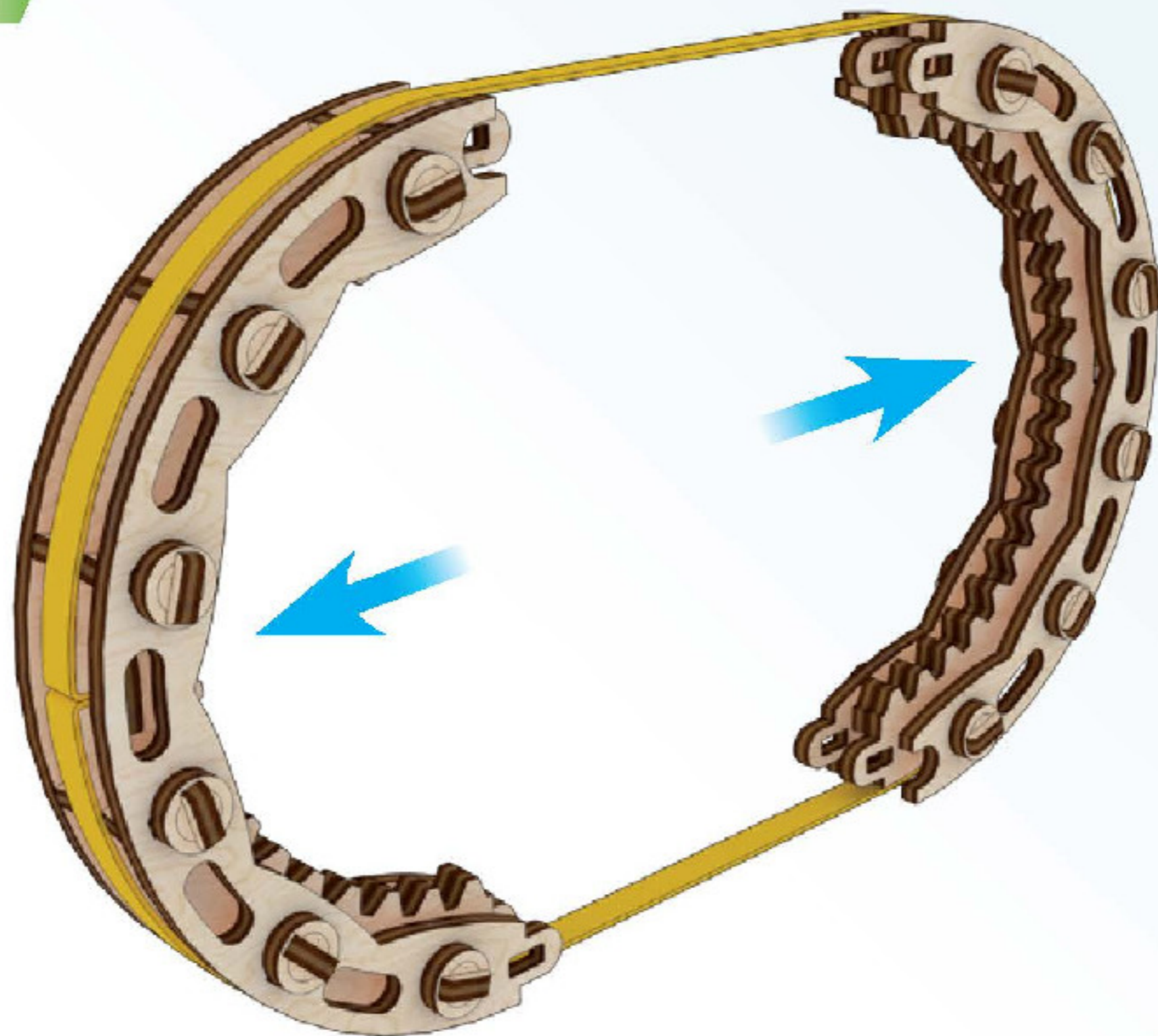

5

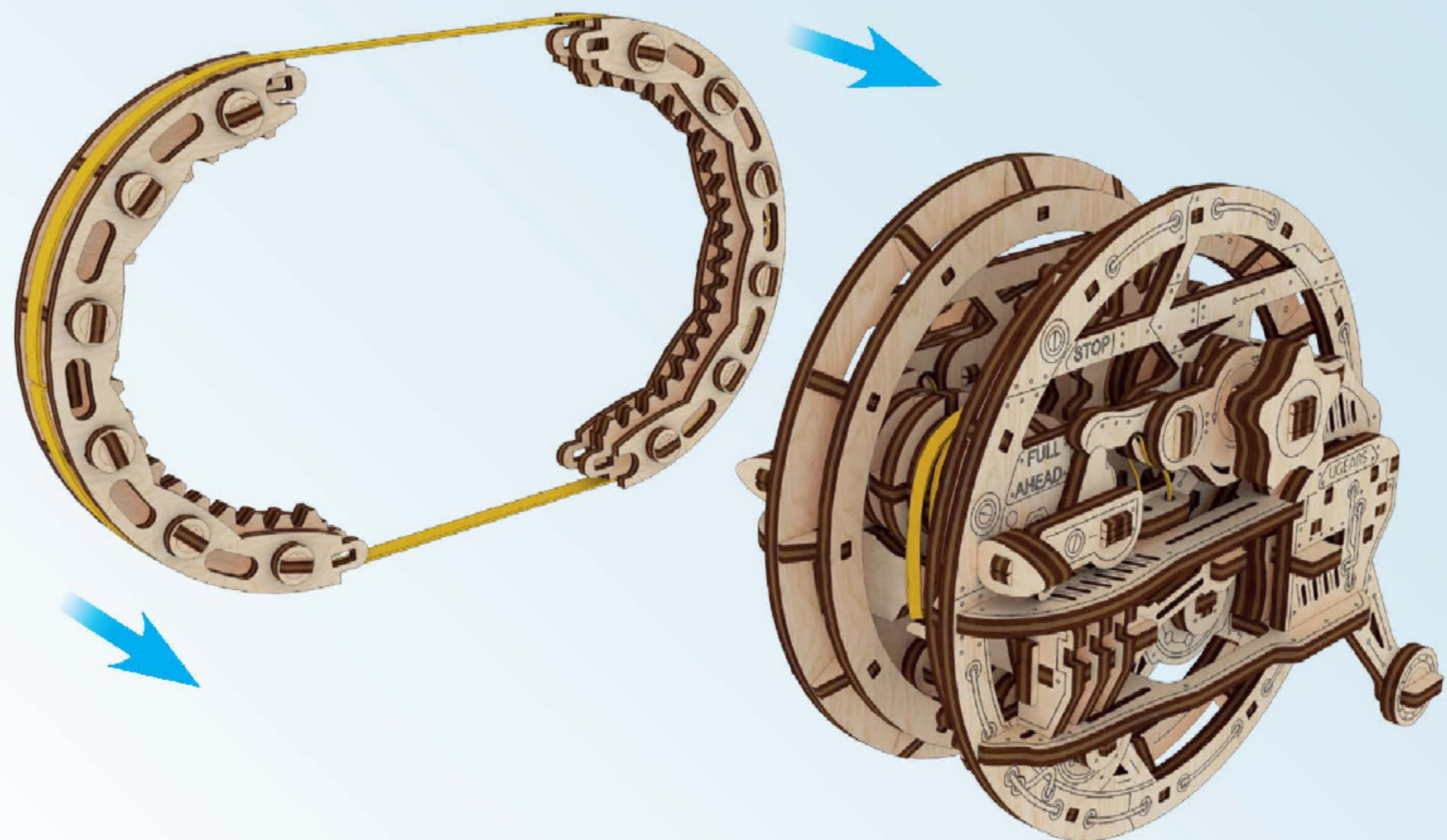

Mechanical models

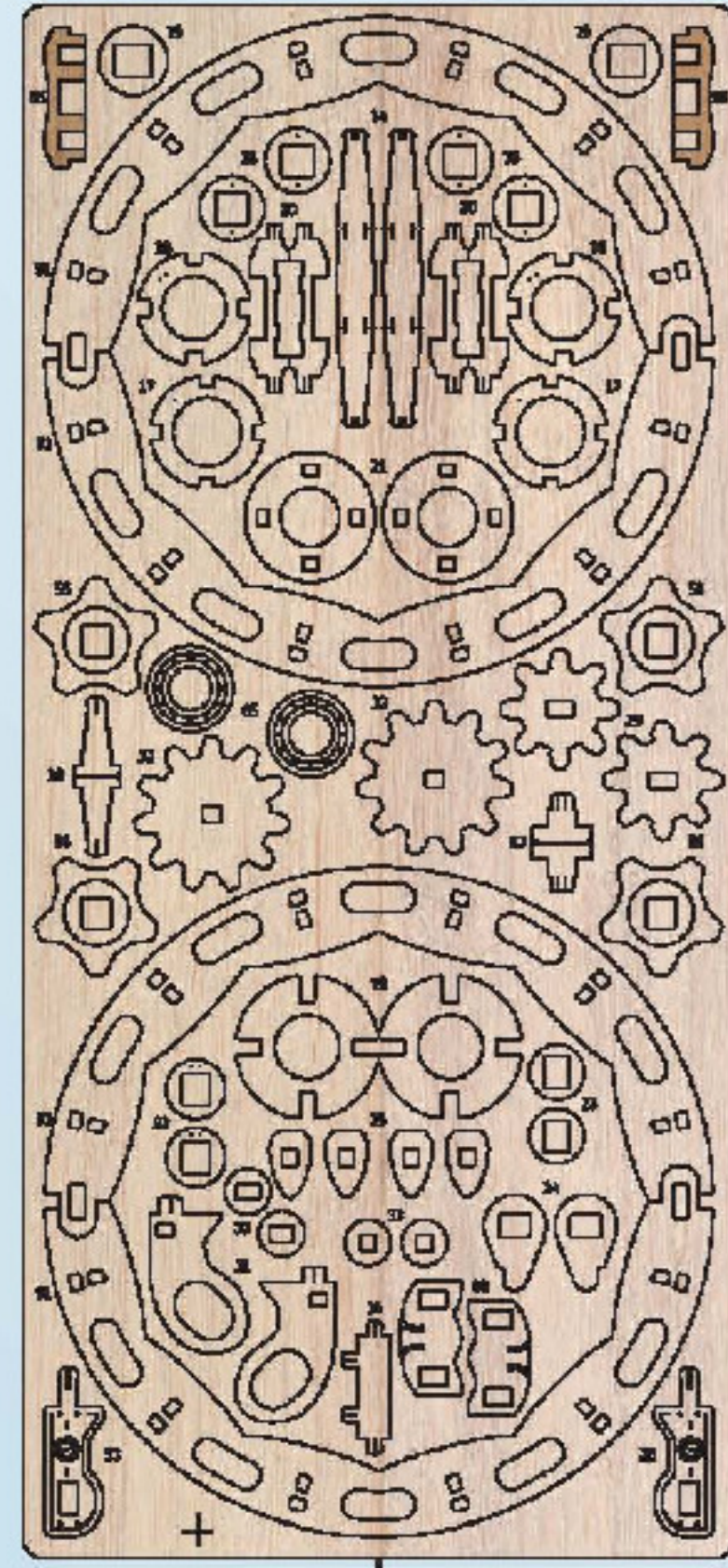

6

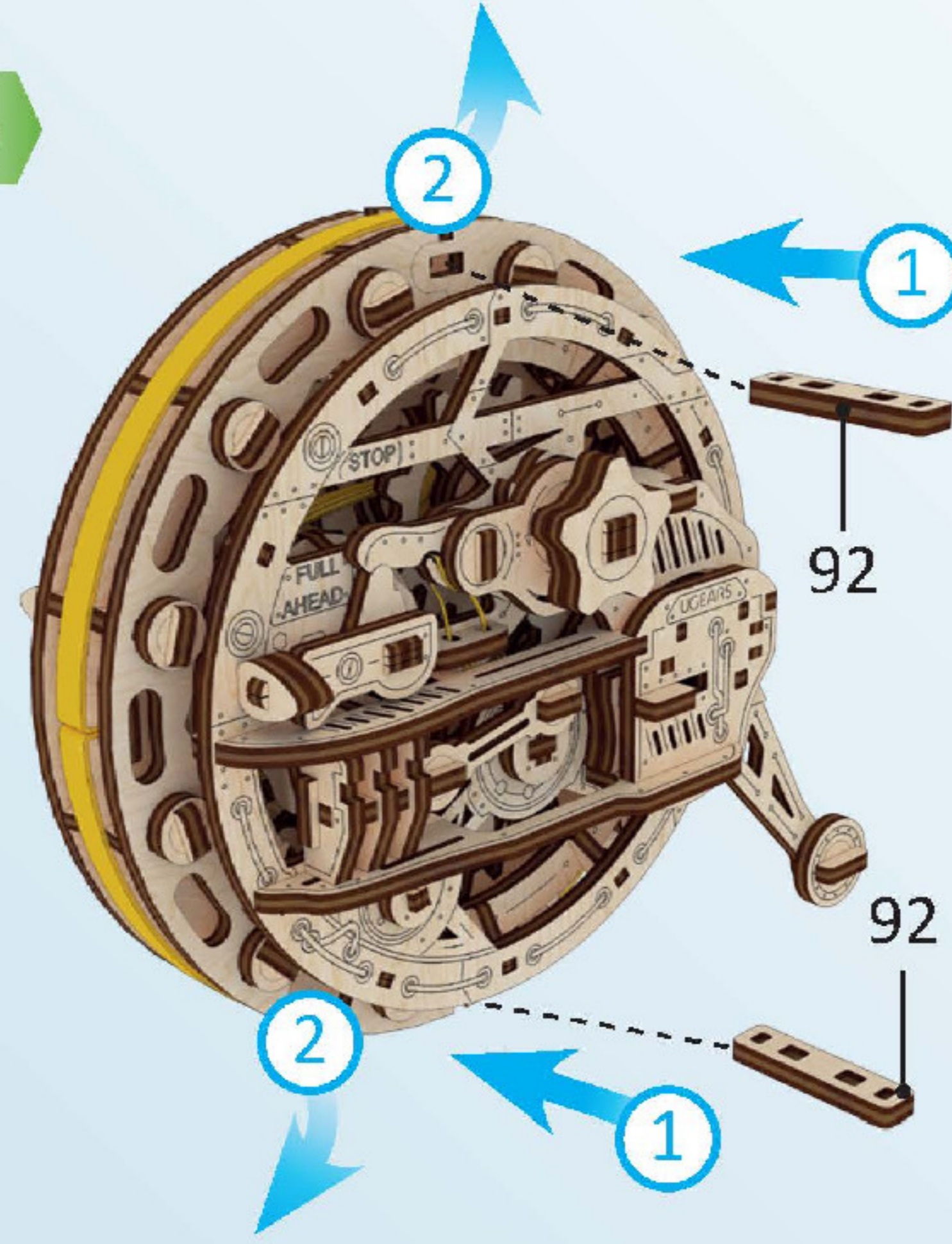

7

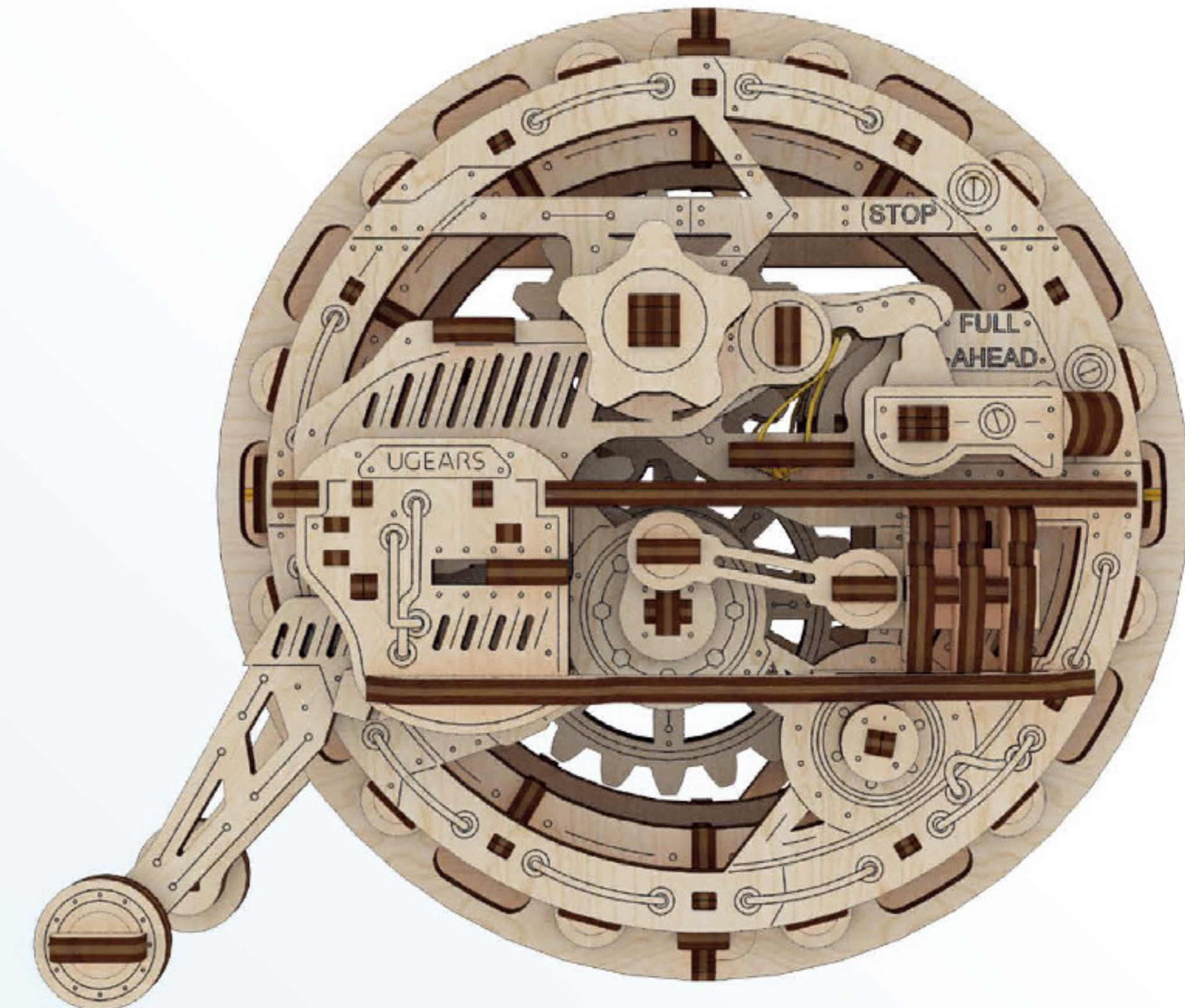
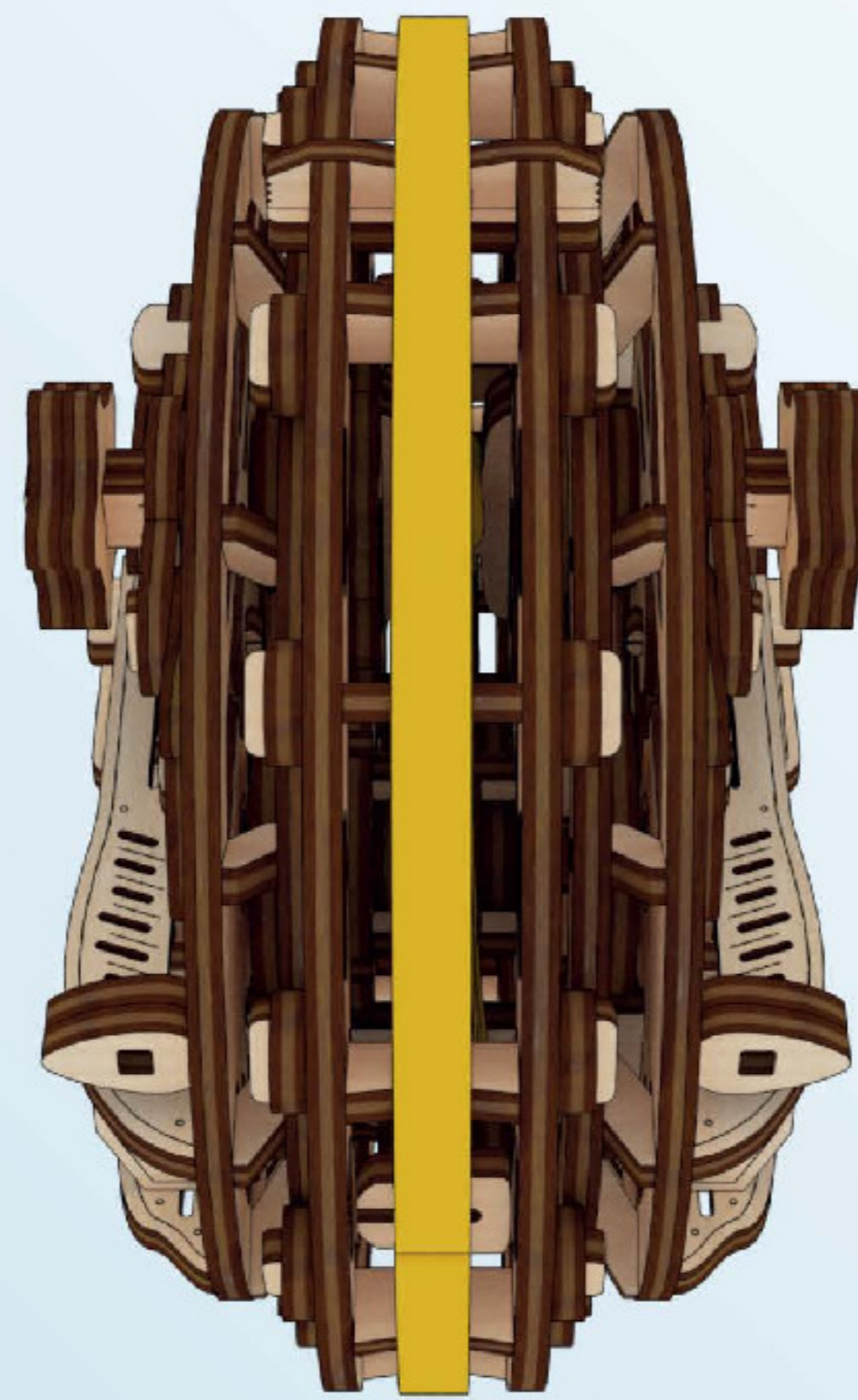
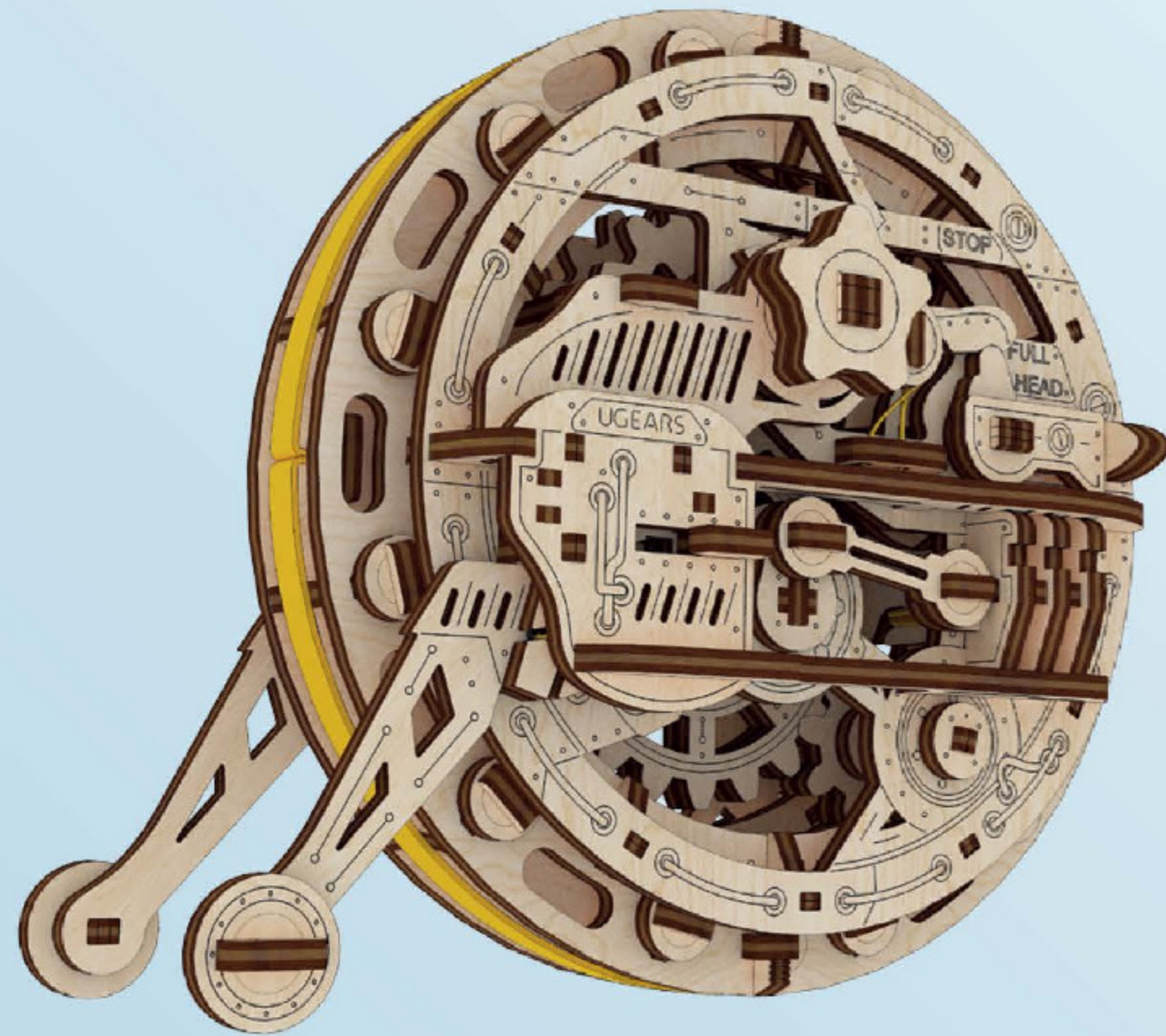
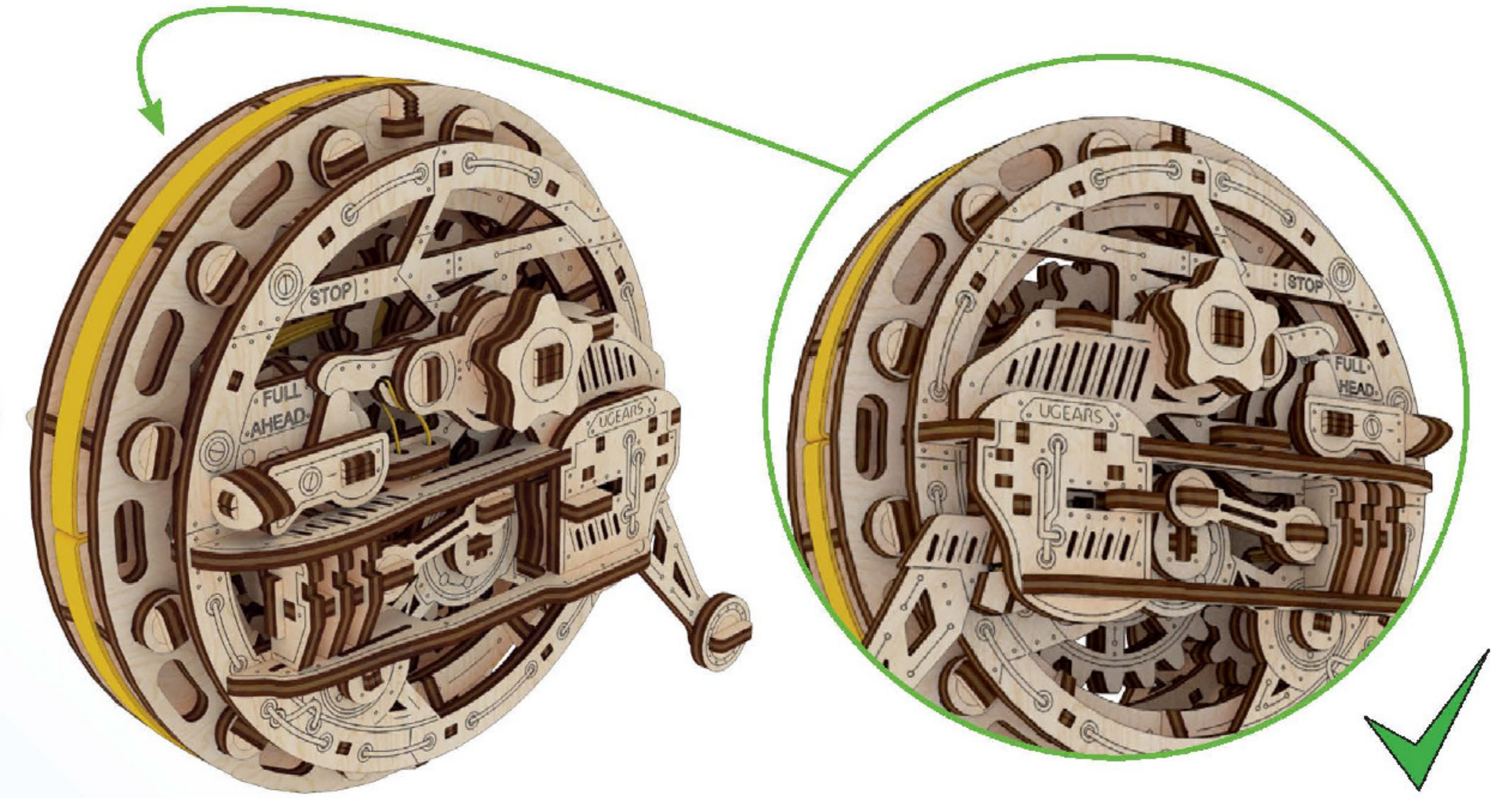
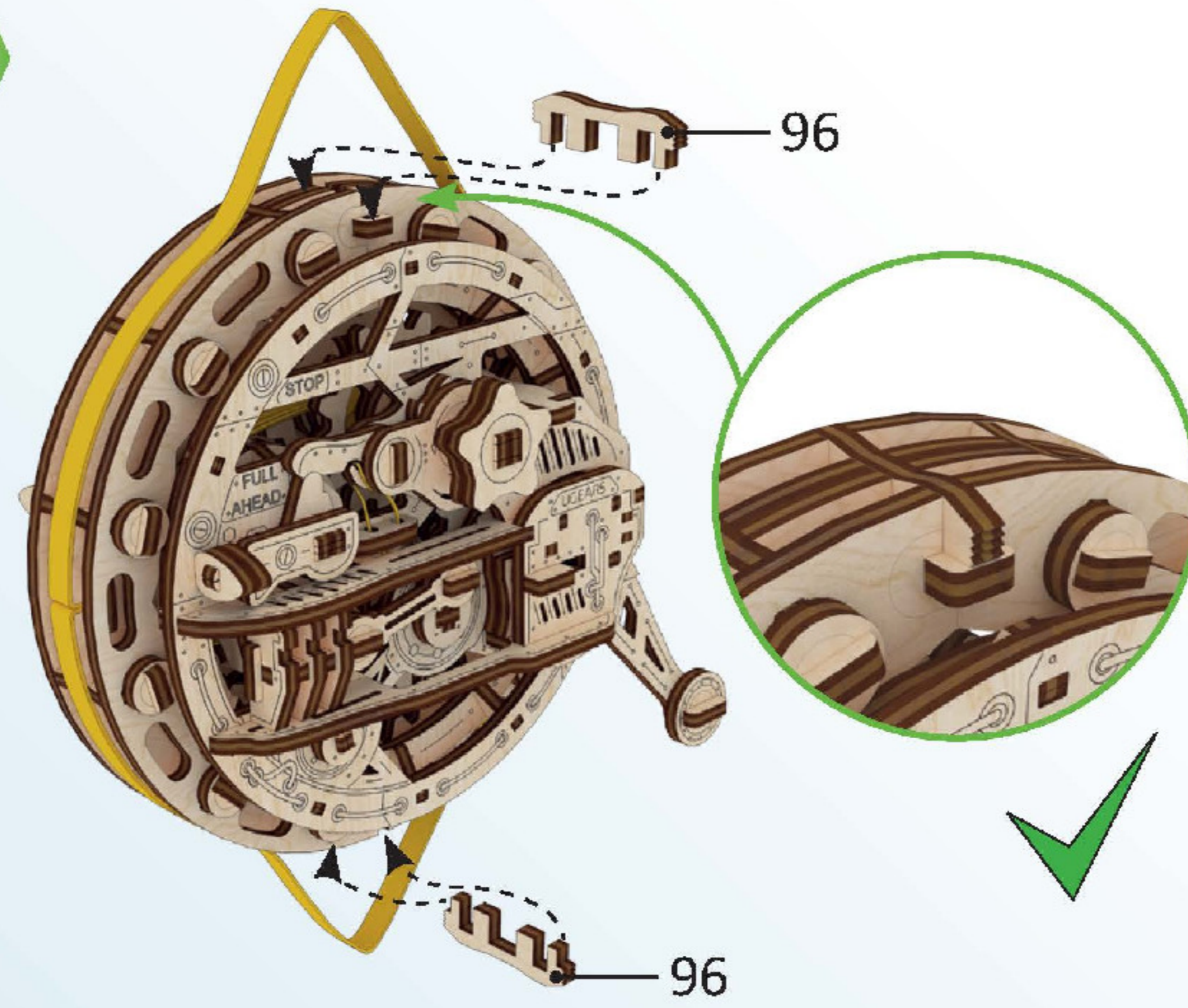

1

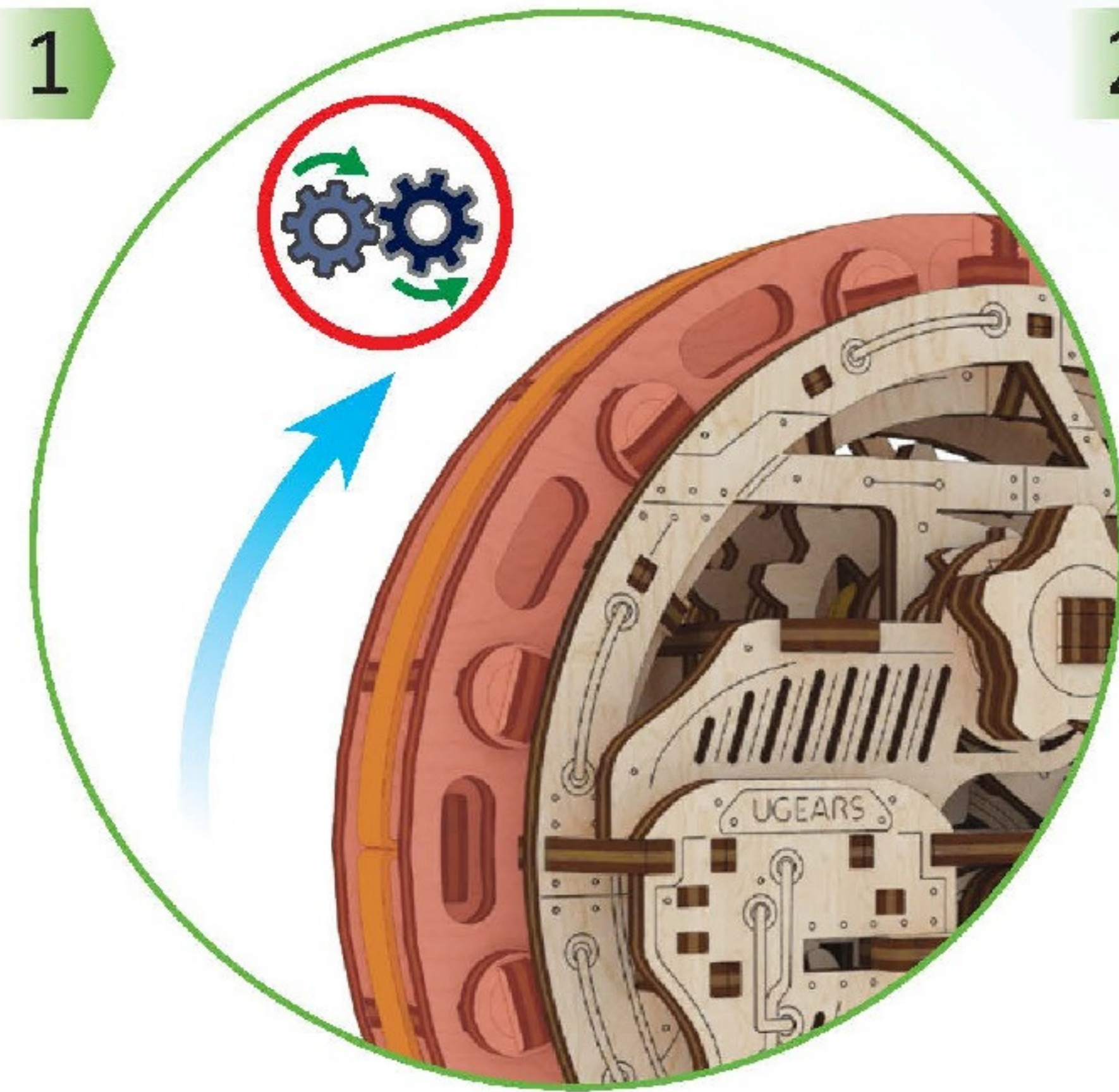

2

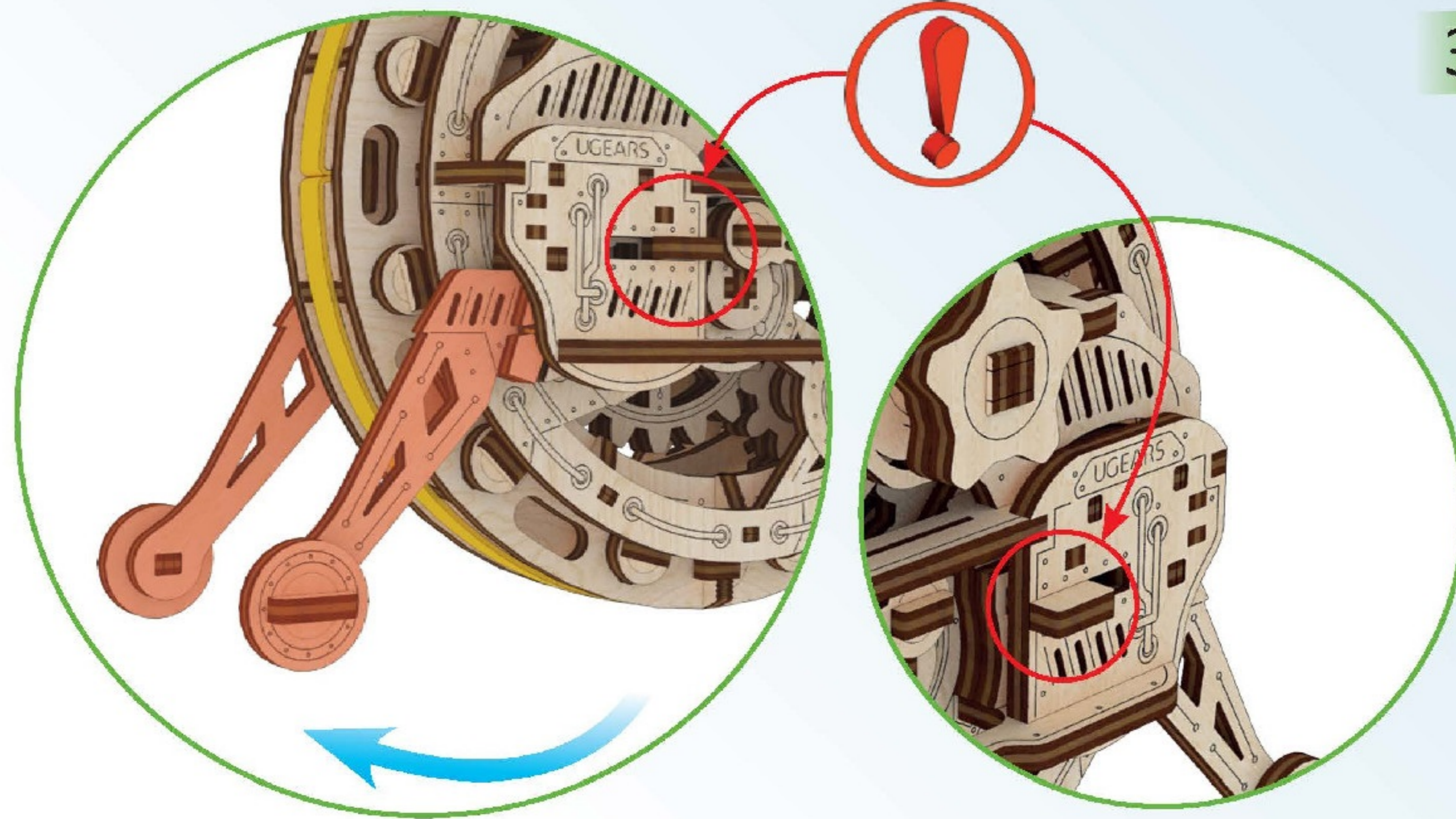

3

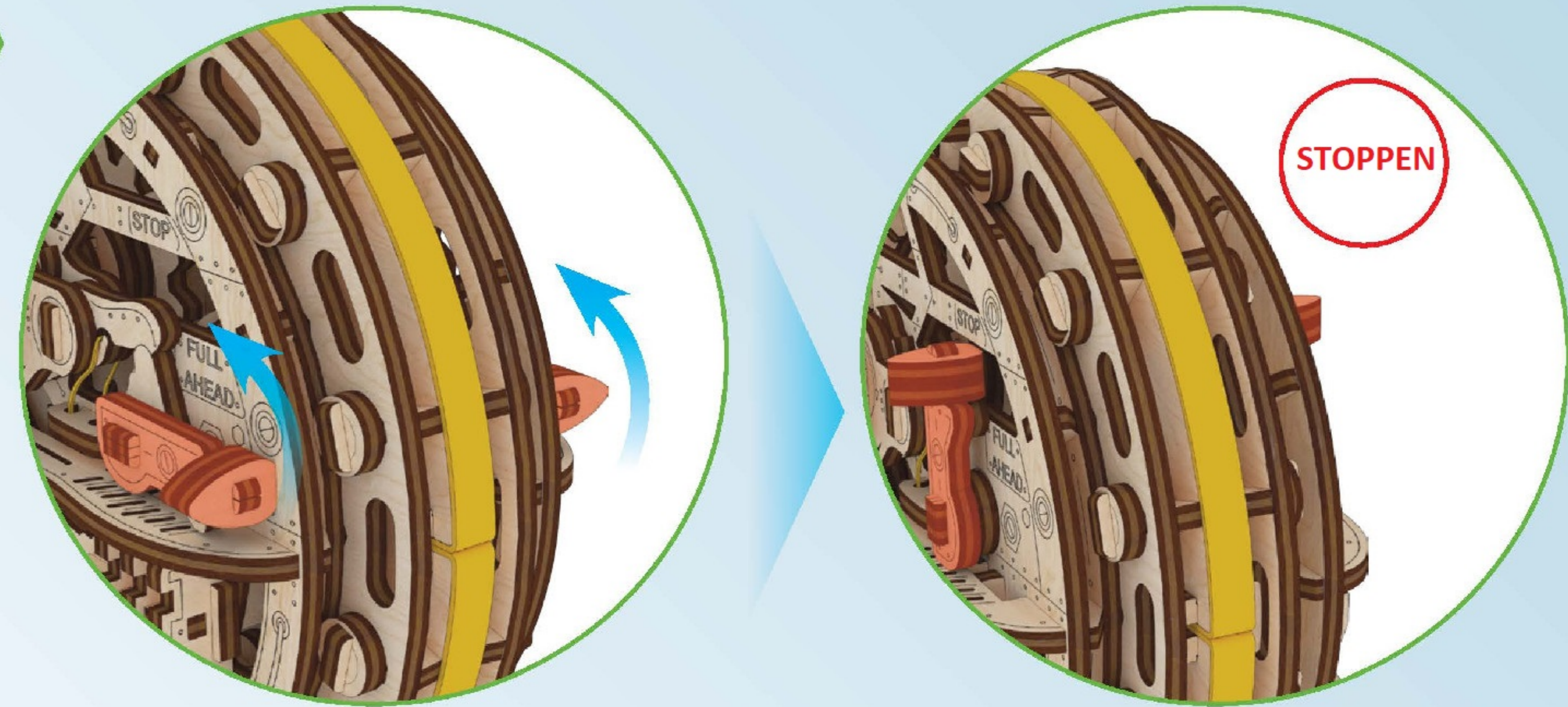

4

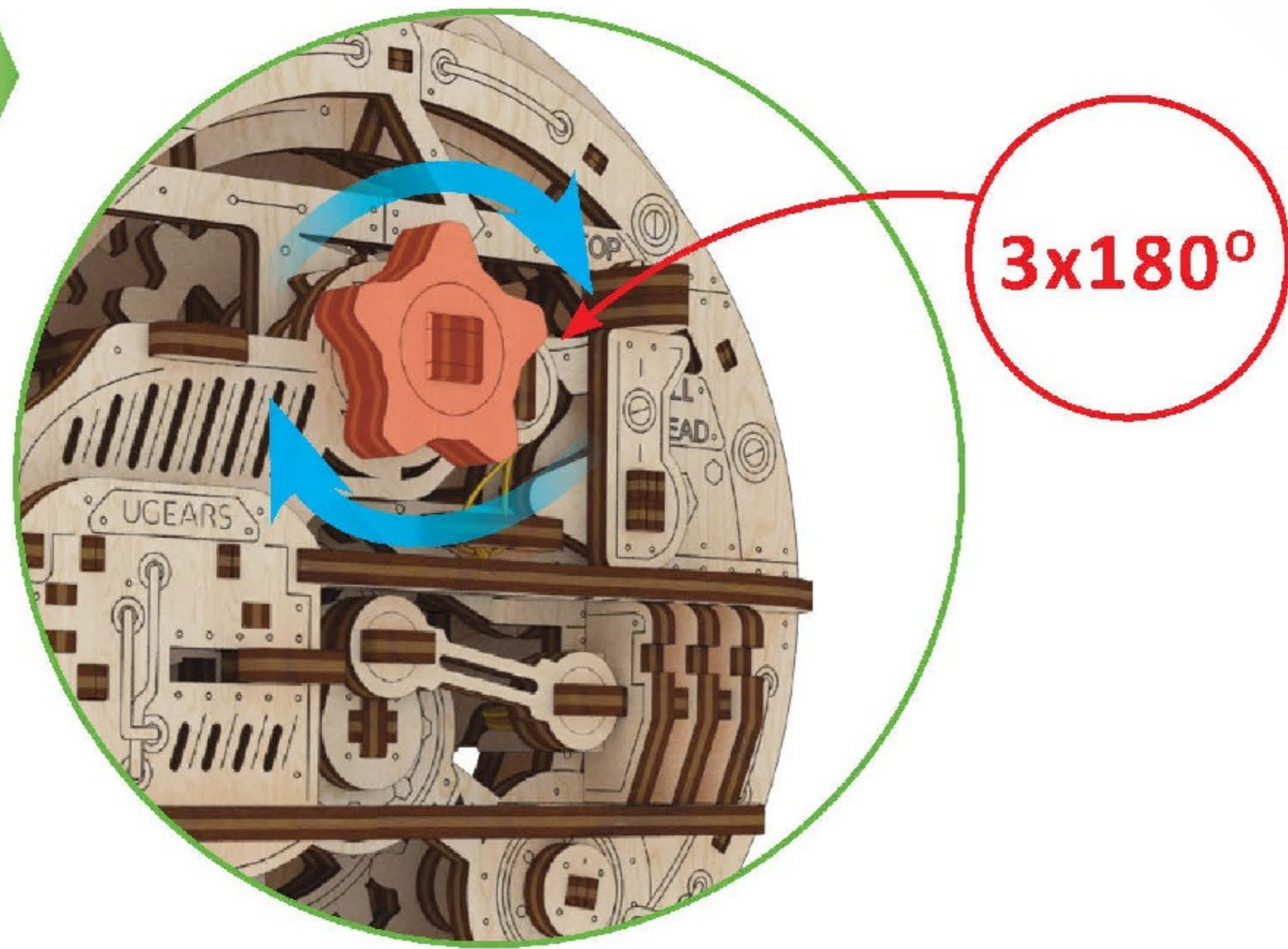

5

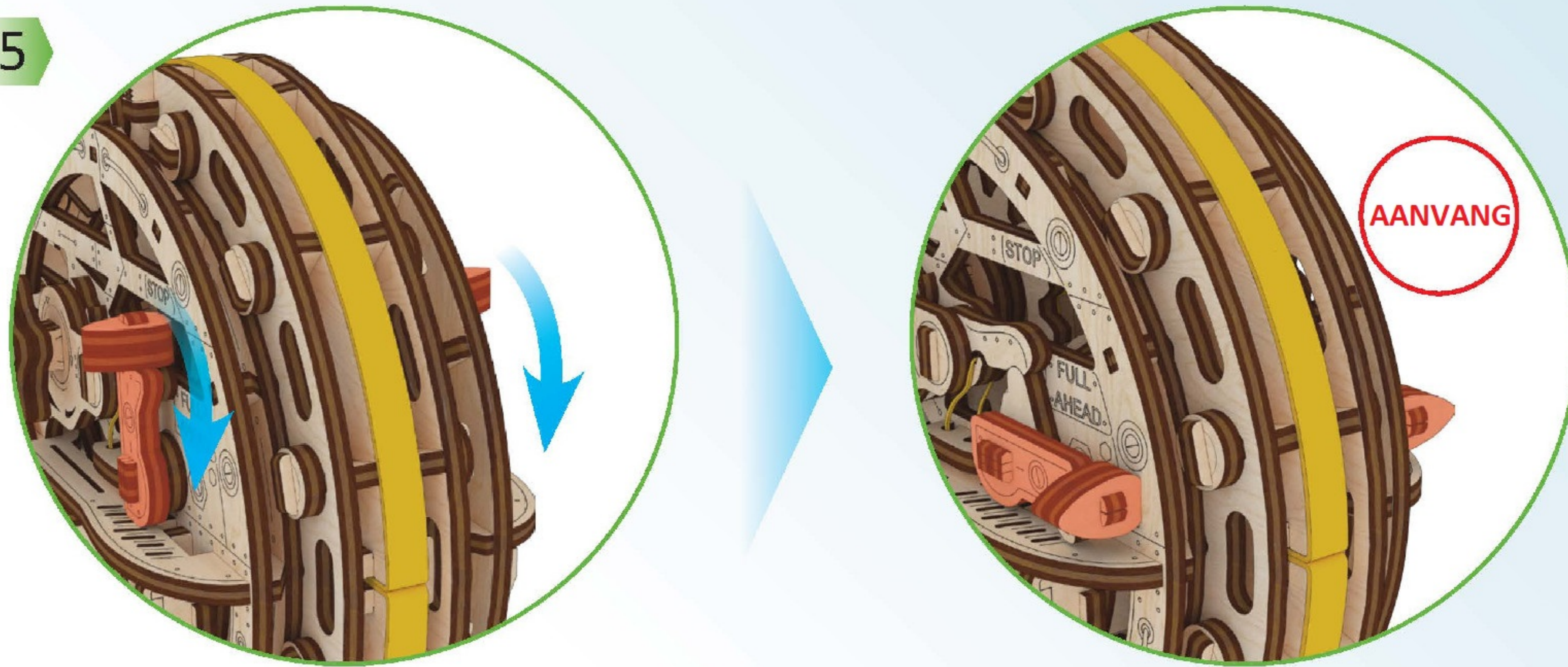

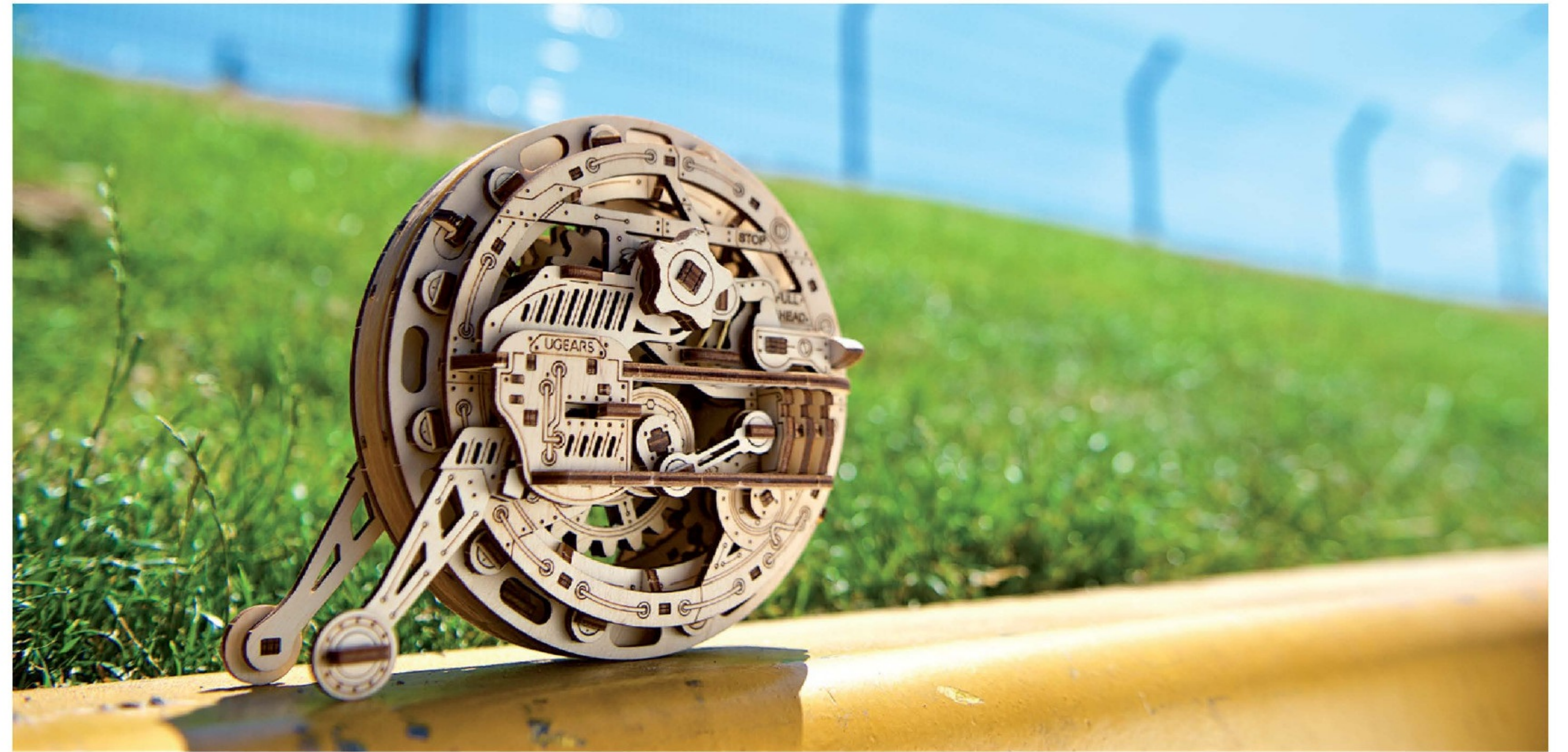
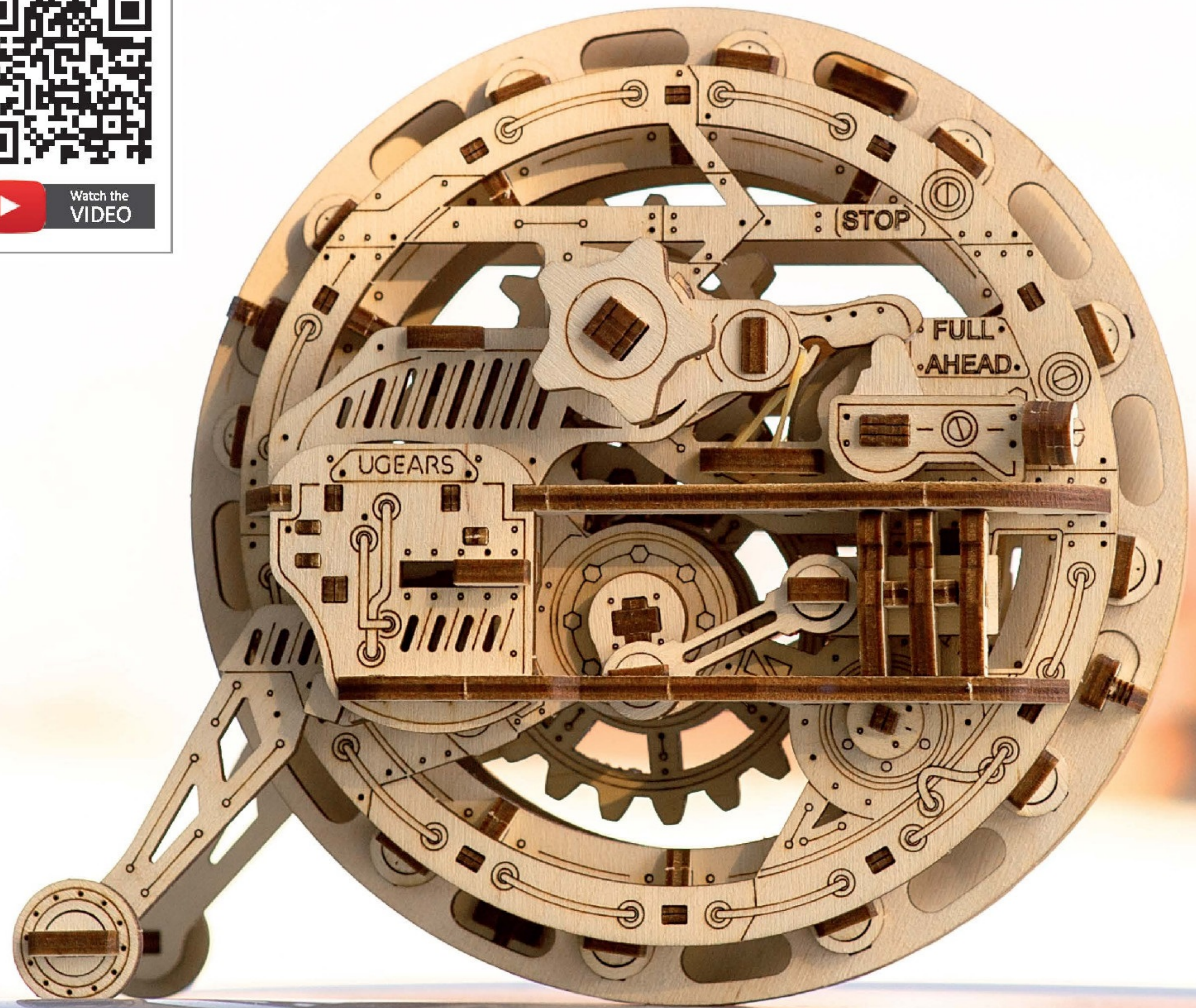

**Bedankt voor de deelname
aan deze reis met ons.**

ugears-shop.nl