



Find out MORE



NATURAL



NO GLUE  
CONNECTION



SELF ASSEMBLY



MECHANICAL



EDUCATIONAL

  
**UGEAR.S®**  
Mechanical models

## "Draaimolen"

DEU Modell «Karussell». FRA Modèle «Carrousel».  
POL Model «Karuzela». SPA Modelo «Carrusel».  
ITA Modello «Giostra». RUS Модель «Карусель».  
JAP メリーゴーラウンド KOR 회전목마  
CHI 旋转木马

## Handleiding in het Nederlands

DEU Aufbauanleitung. FRA Notice d'assemblage.  
POL Instrukcja montażu. SPA Instrucciones de montaje.  
ITA Istruzioni di montaggio. RUS Инструкция по сборке.  
JAP 組み立て説明書 KOR 조립 설명서.  
CHI 装配说明书

**Assemble Me. Behold the Magic of the Fair**



## NED

### Bouwinstructies.

Verwijder de onderdelen van de borden zoals hieronder is geïllustreerd. Pas op dat de onderdelen niet breken. Wanneer het niet loskomt, gebruik dan voorzichtig een mesje. Dit model bouwt u zelf zonder gebruik te maken van lijm. Wanneer onderdelen moeilijk te plaatsen zijn. Smeer deze dan in met een kaars. Om frictie te voorkomen behandelt u ook alle beweegbare onderdelen met een kaars.

### Waarschuwing!



Gebruik geen kaars die brand!



Opgepast, de spieën zijn scherp!



## Pictogrammen.



Smeer het onderdeel in met kaarsvet.



Opgelet! Controleer de goede positie.



Controleer het mechanisme op een soepele en goede beweging. Breng het mechanisme in beweging om de onderdelen in positie te krijgen.



Controleer grootte.



Het onderdeel moet gemakkelijk te draaien zijn.



Reserveonderdelen.

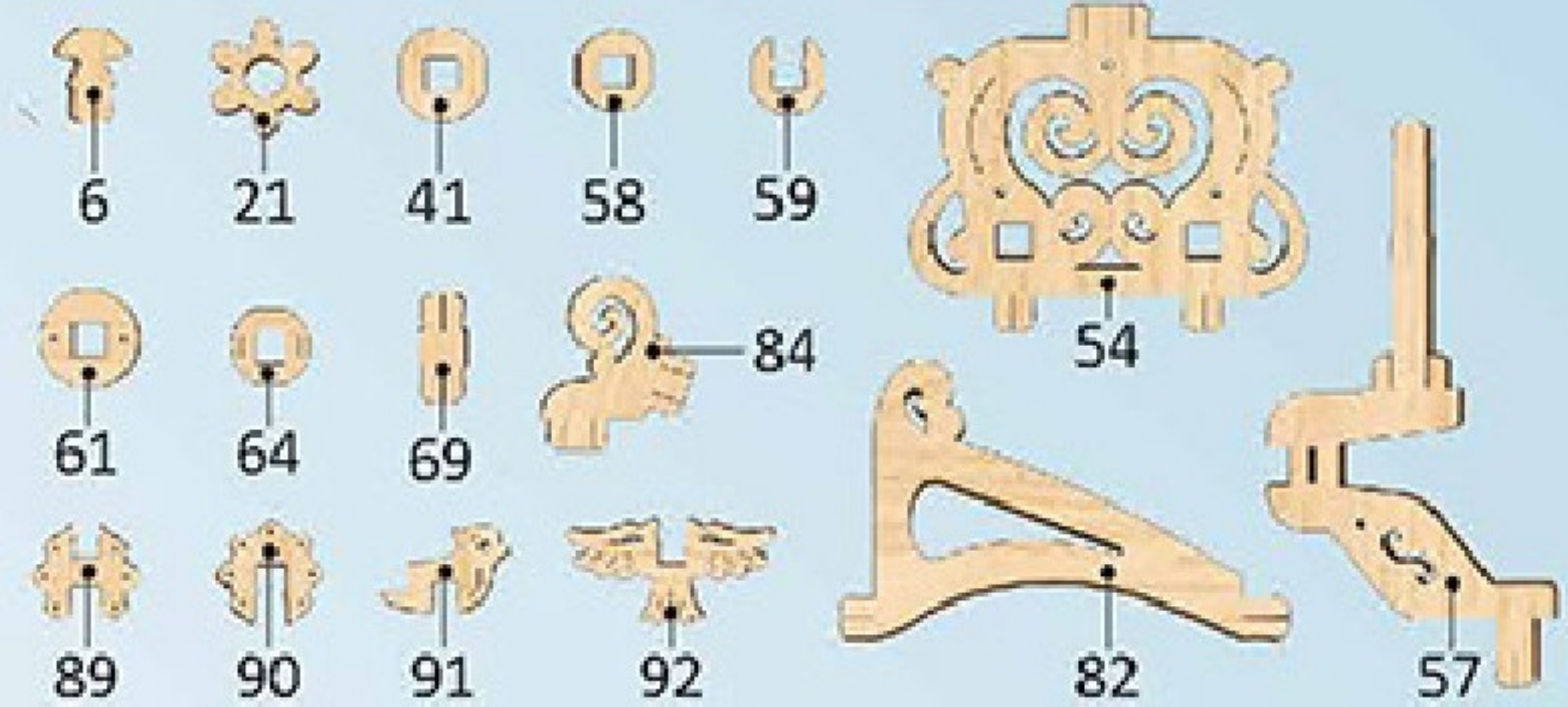

H1

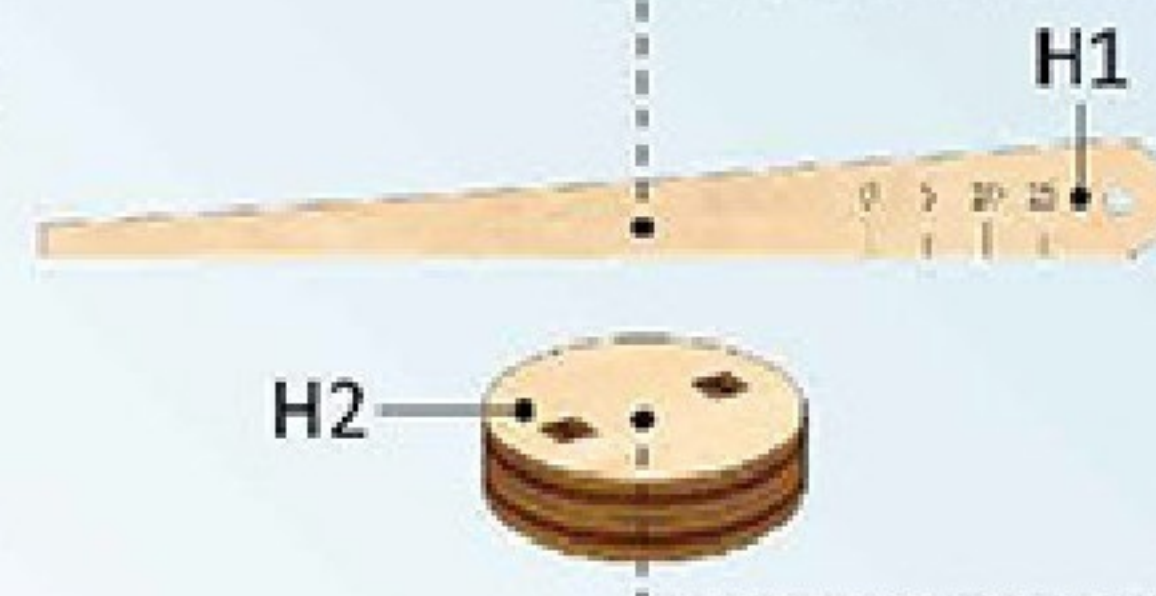

H2

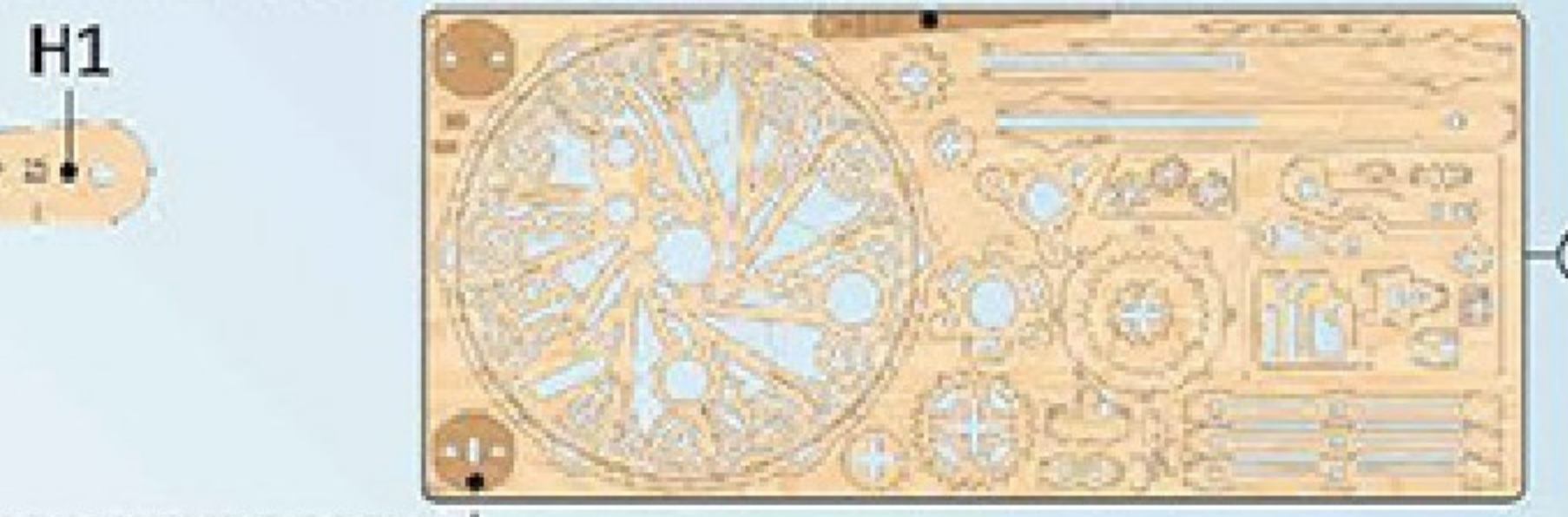

Dit is geen onderdeel. Het is een gereedschap voor meting en montage.  
Leder model heeft z'n eigen gereedschap.



Het is gemakkelijker om sommige onderdelen eruit te trekken met de helper "H1".



①

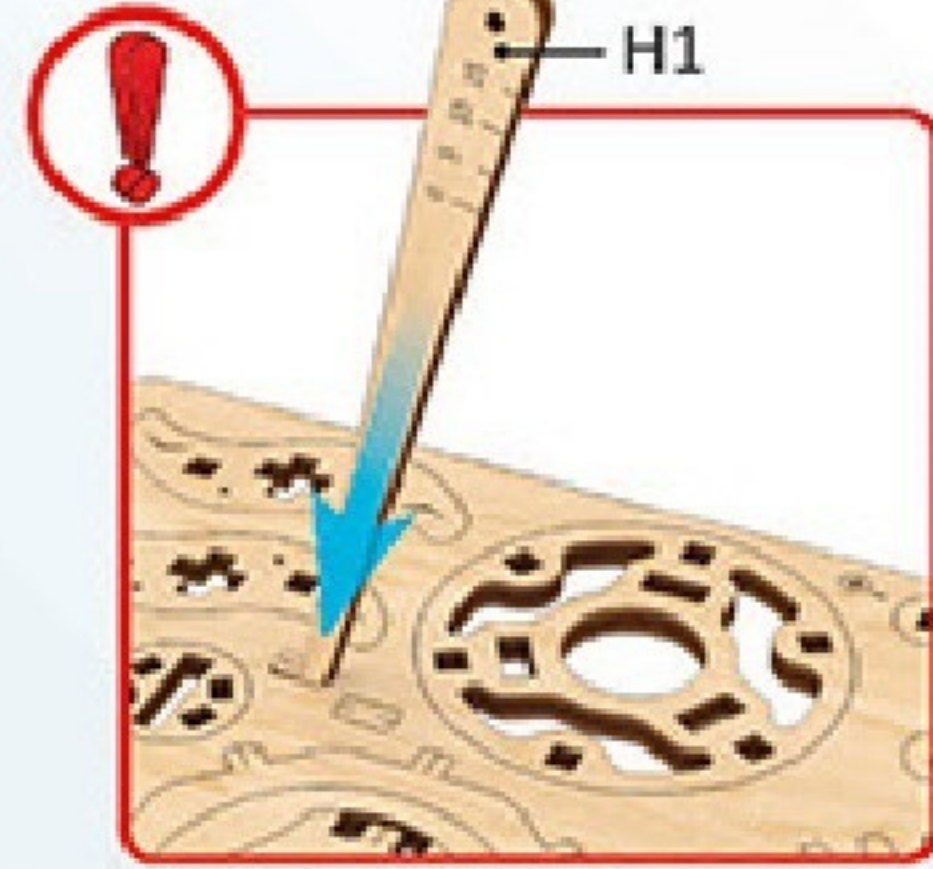
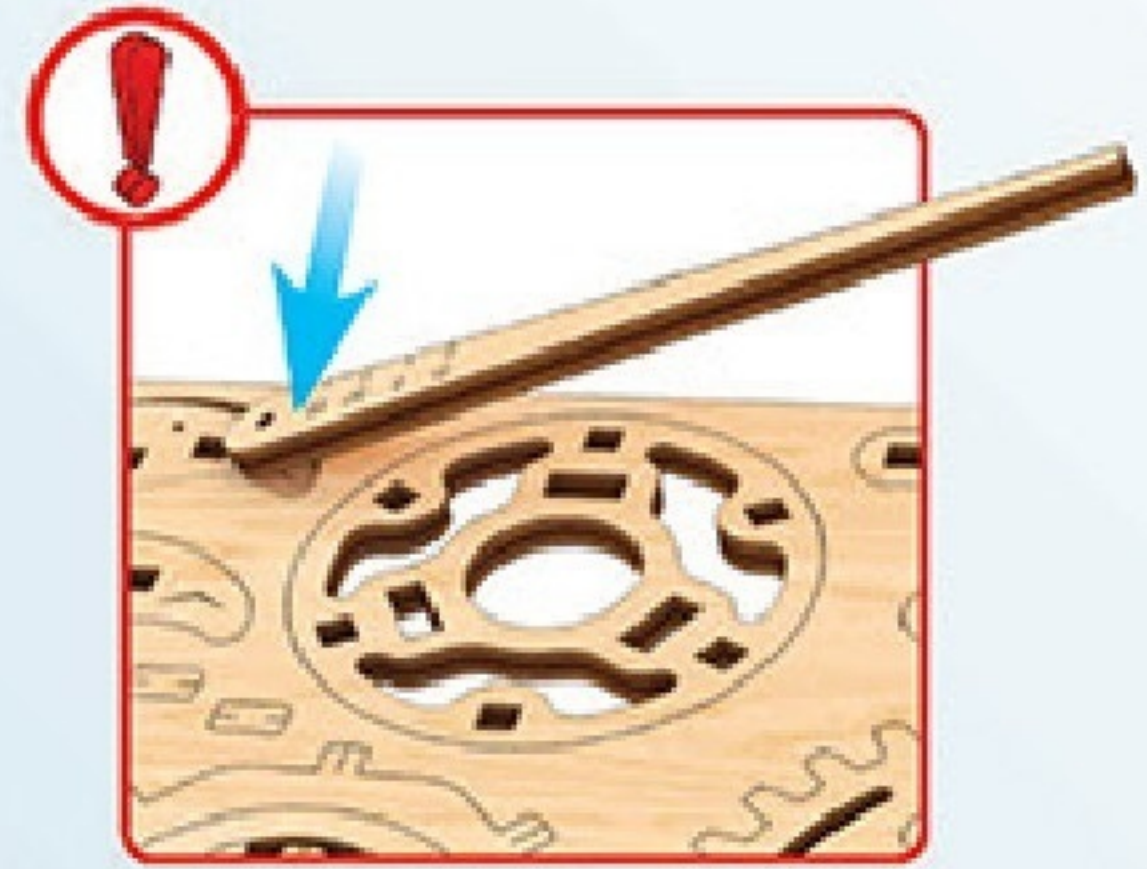
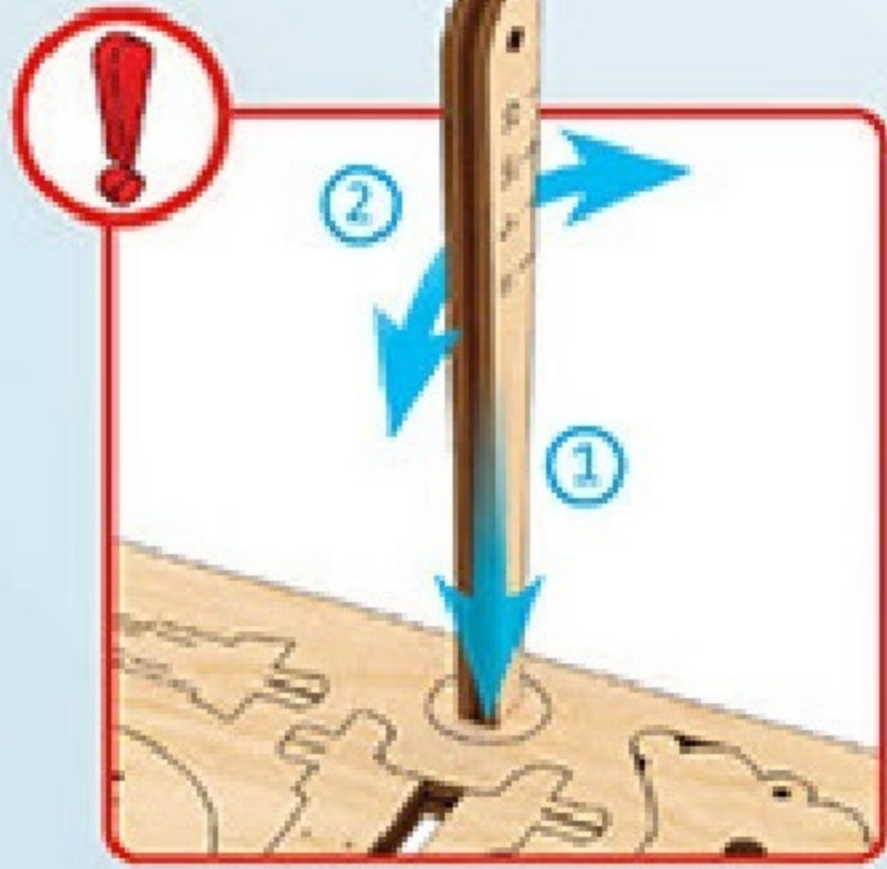

1

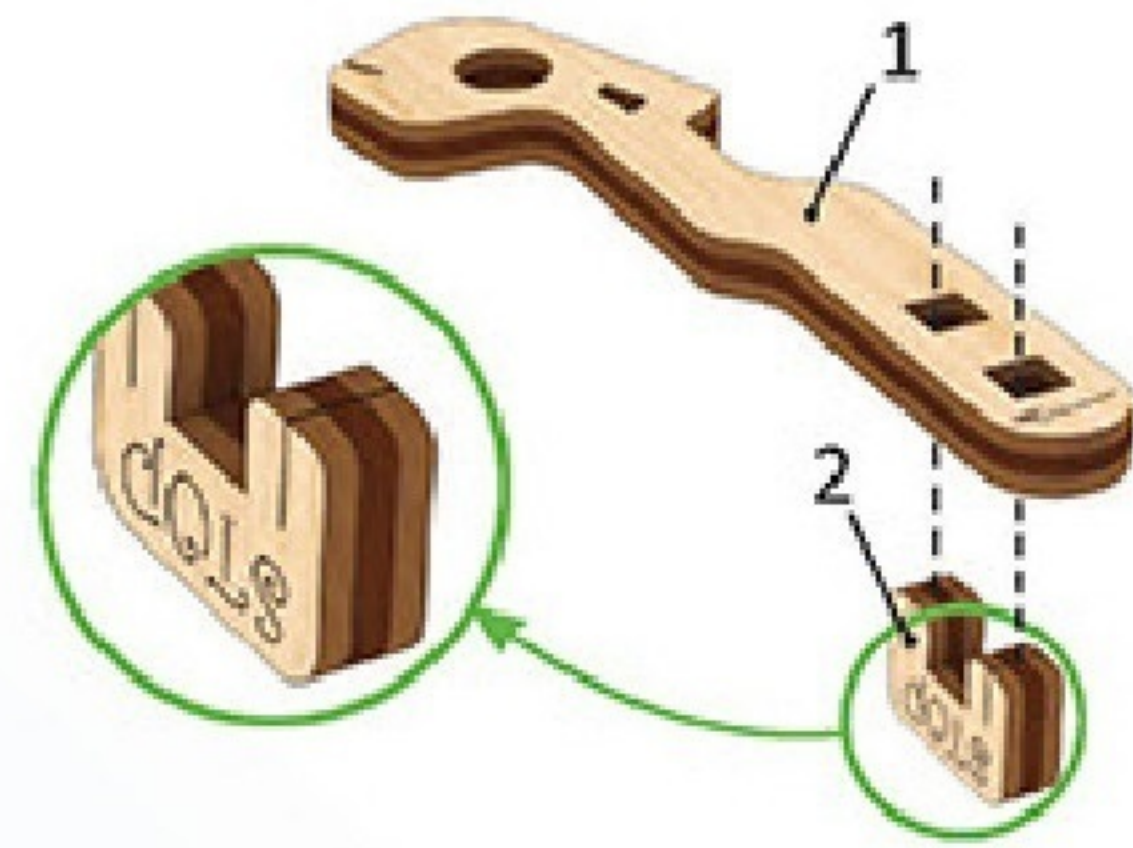

1

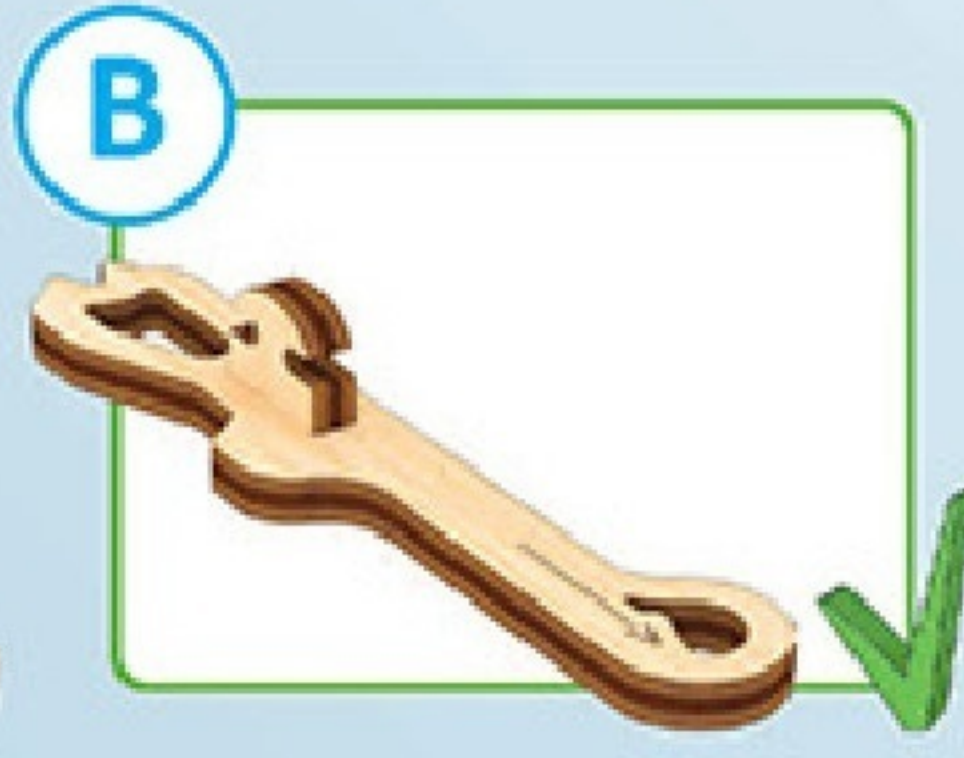
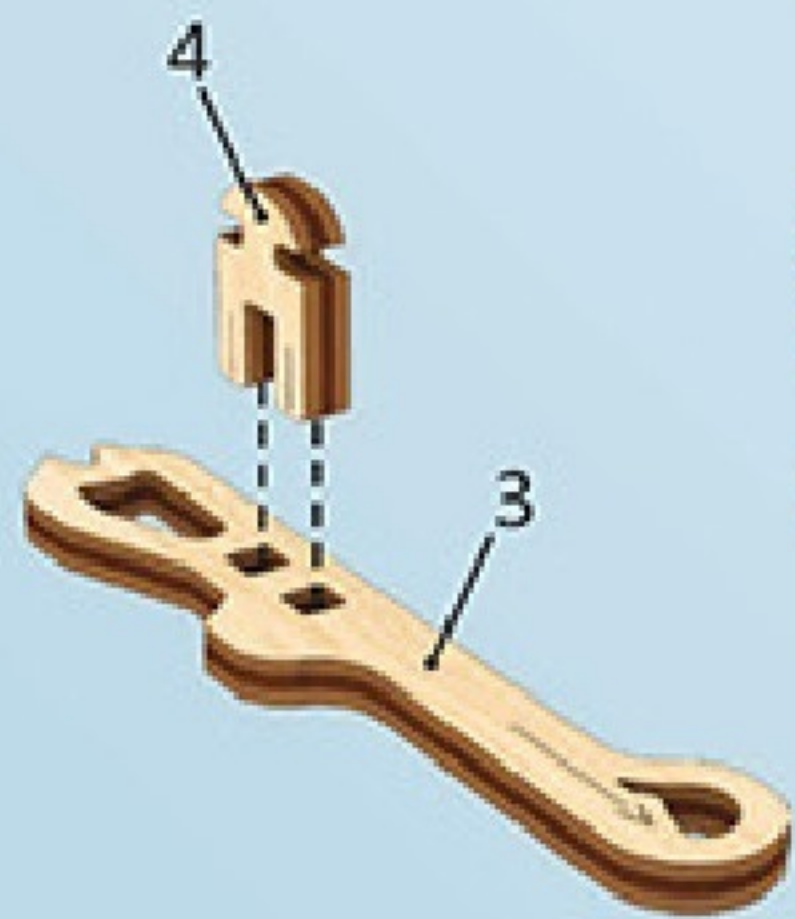

1

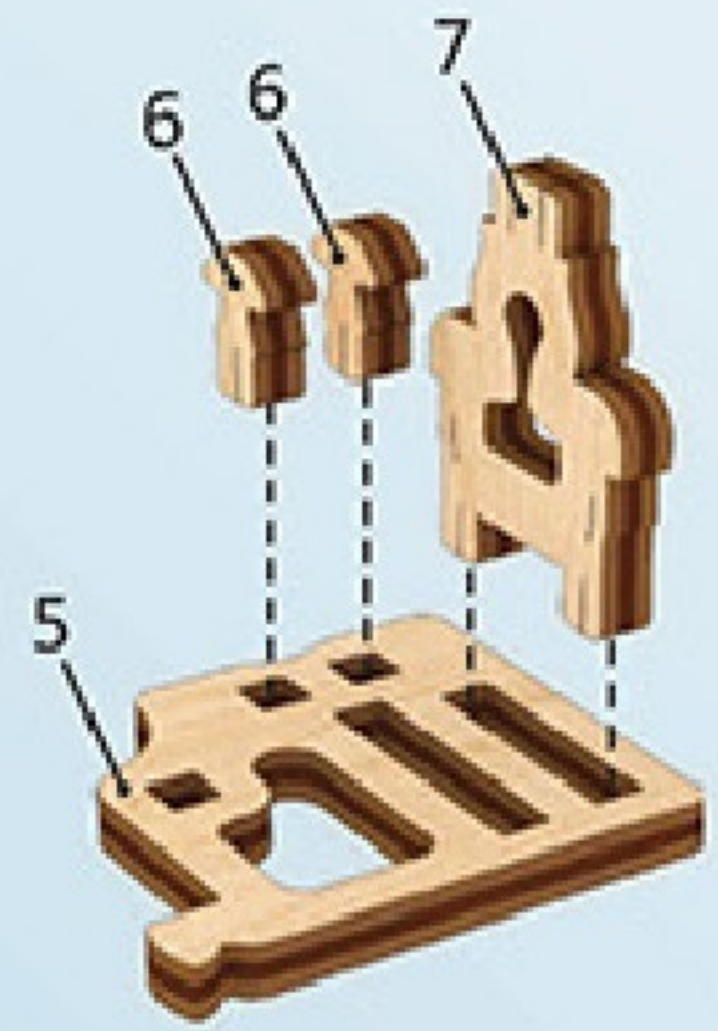

1



2

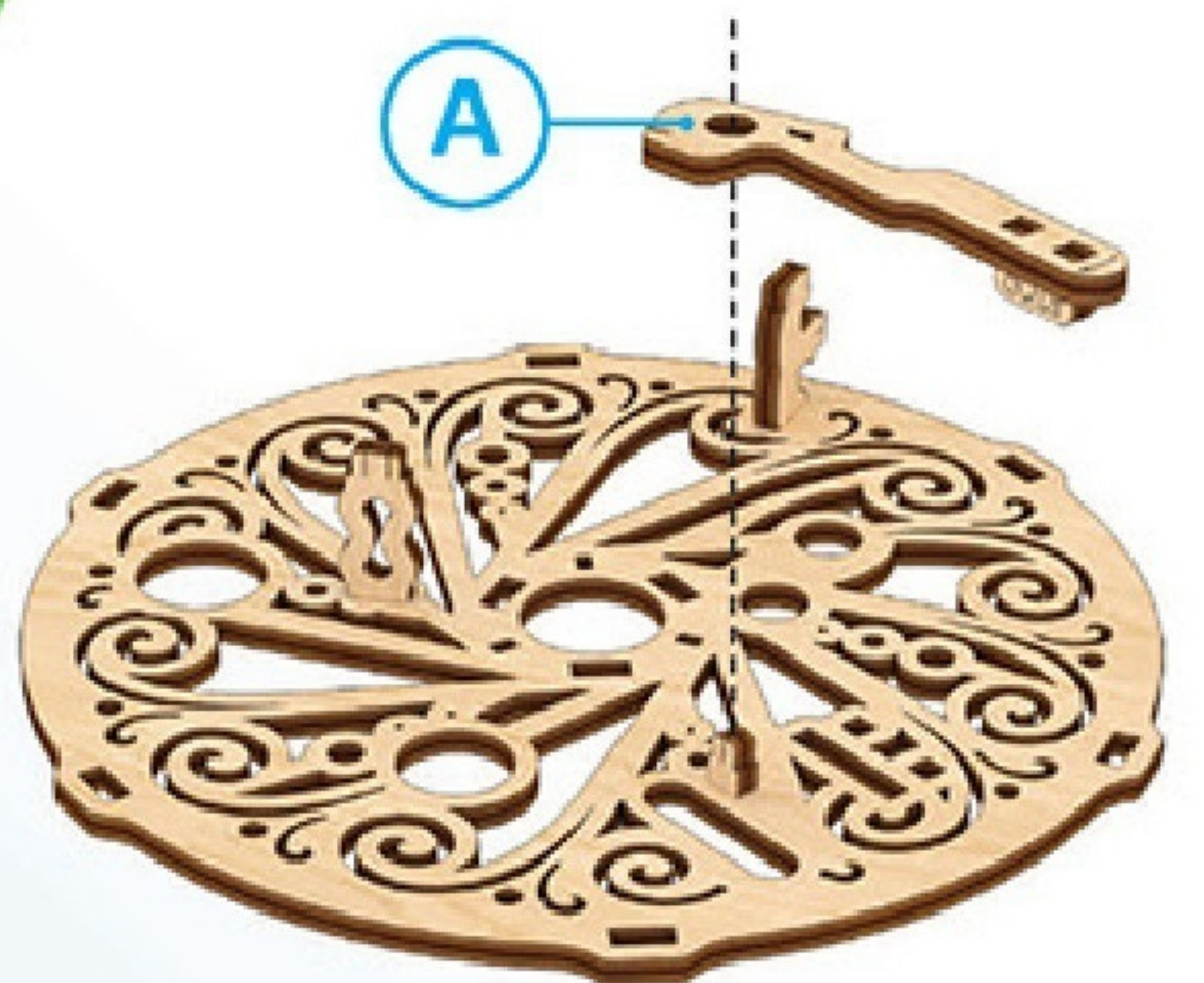

4



3



4

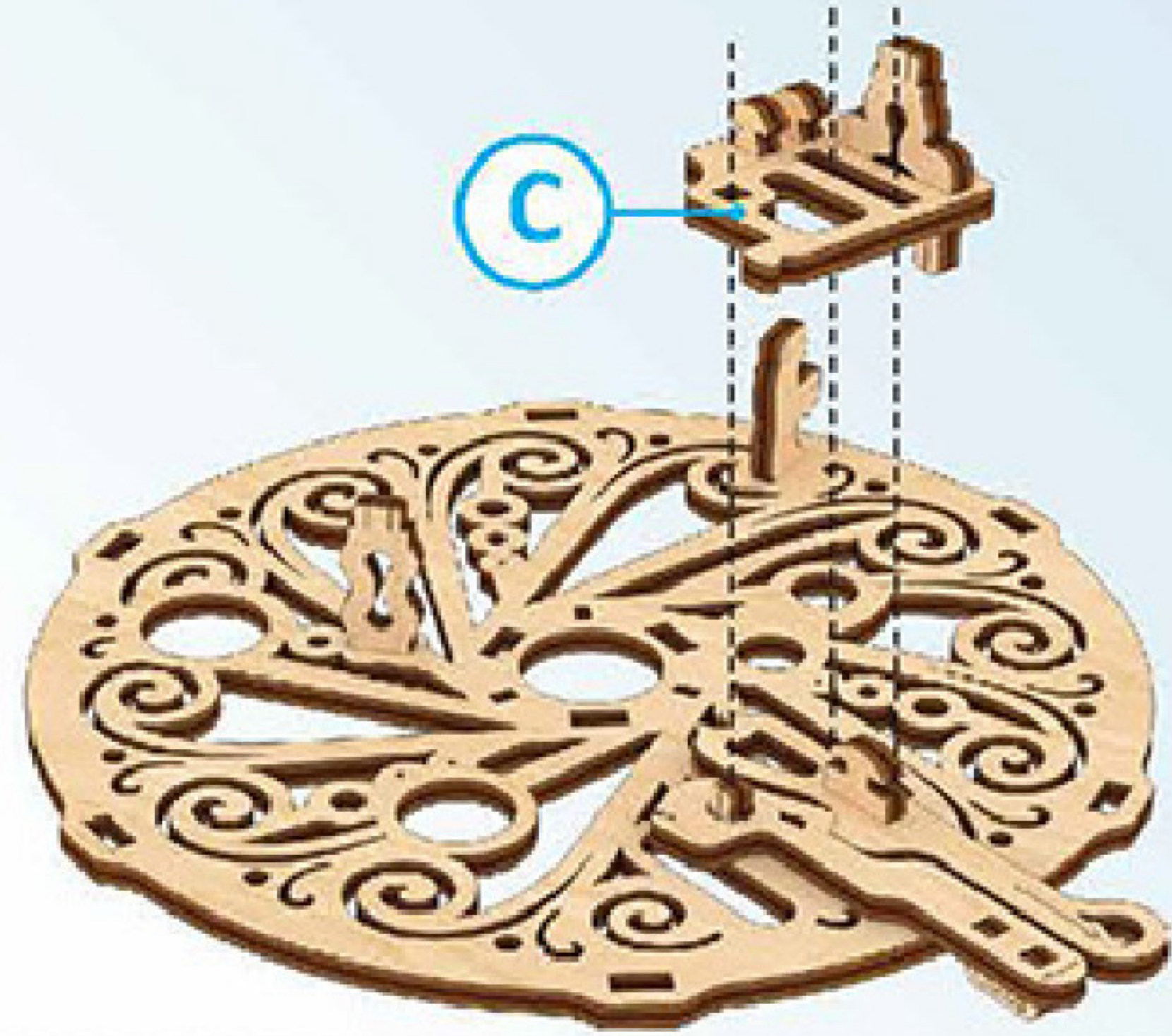

5

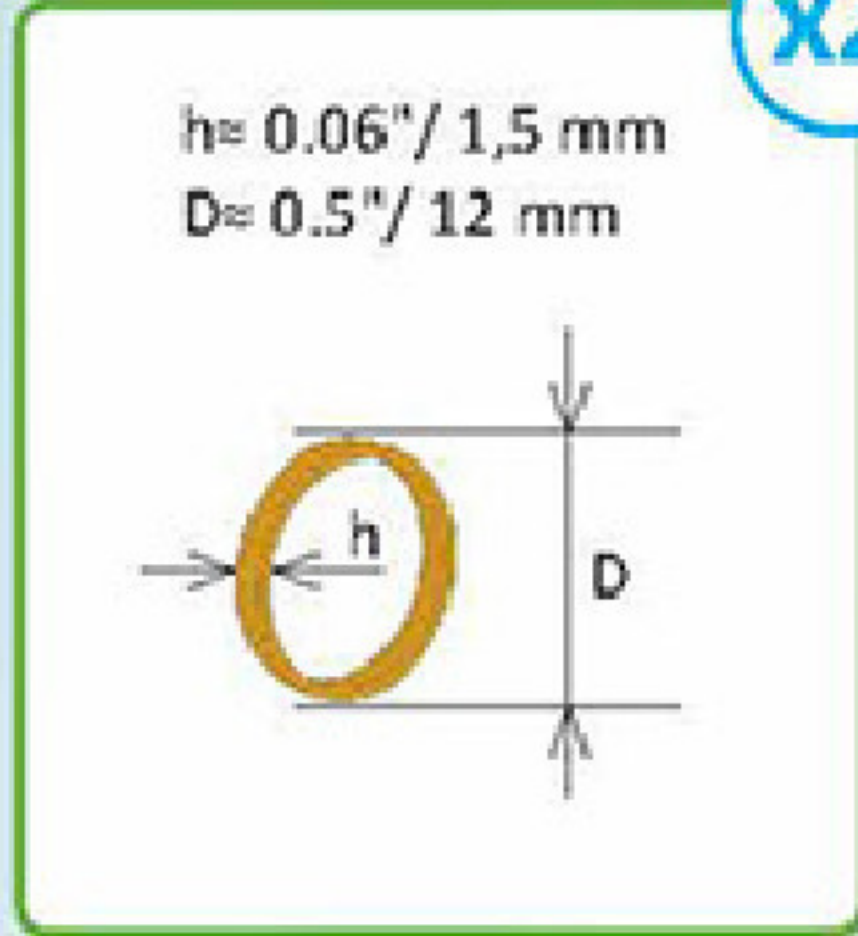

6

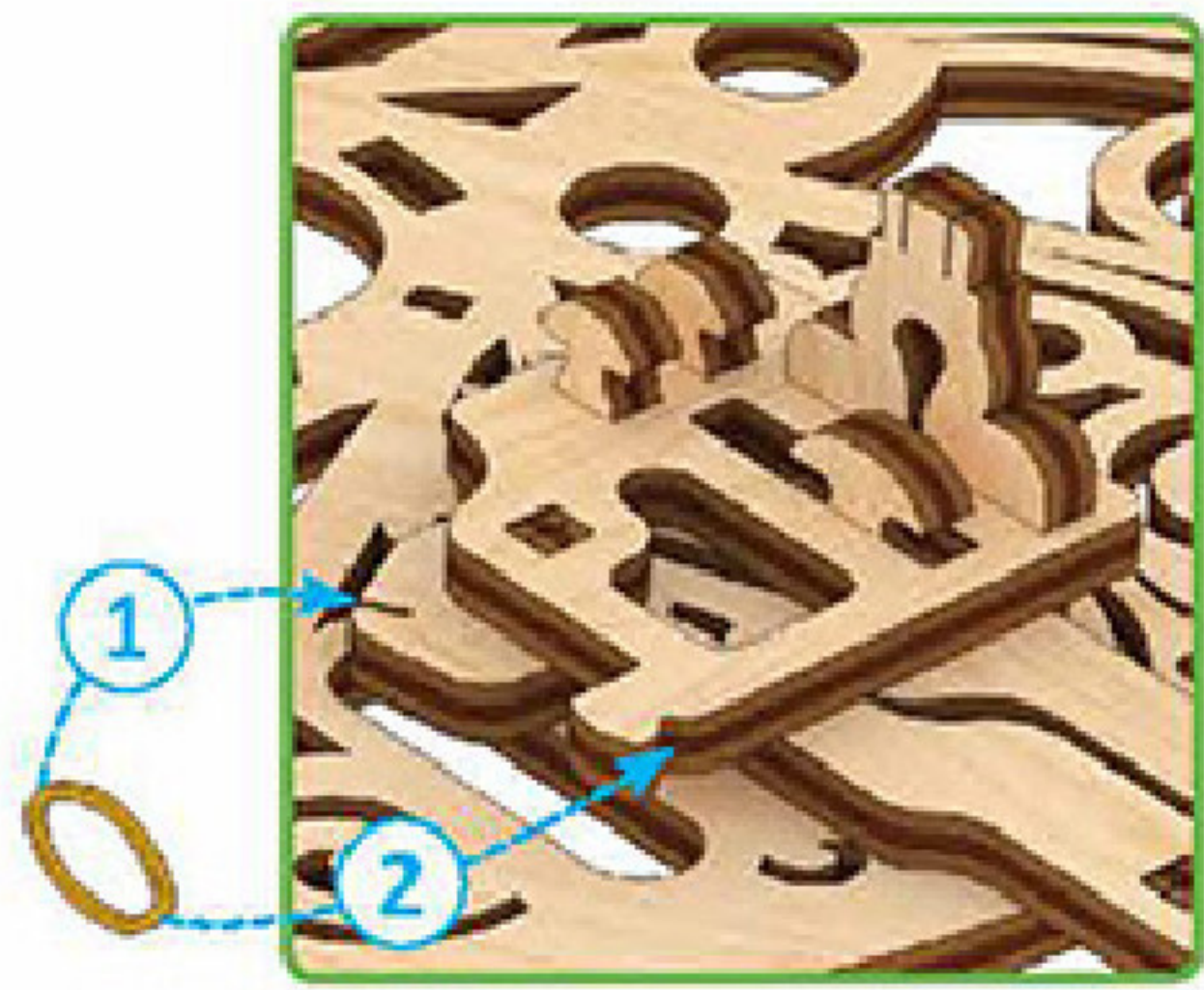

7



8

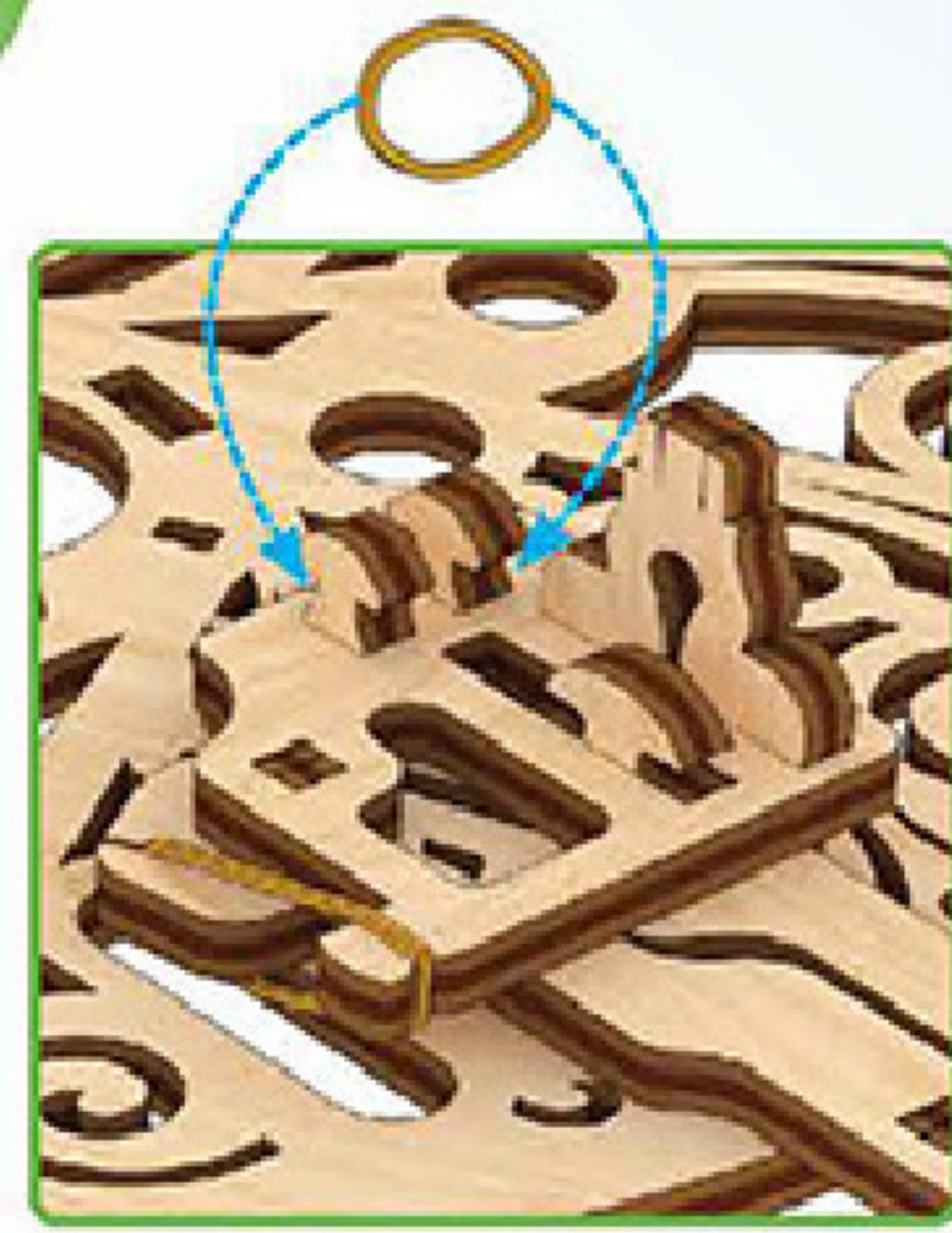

9

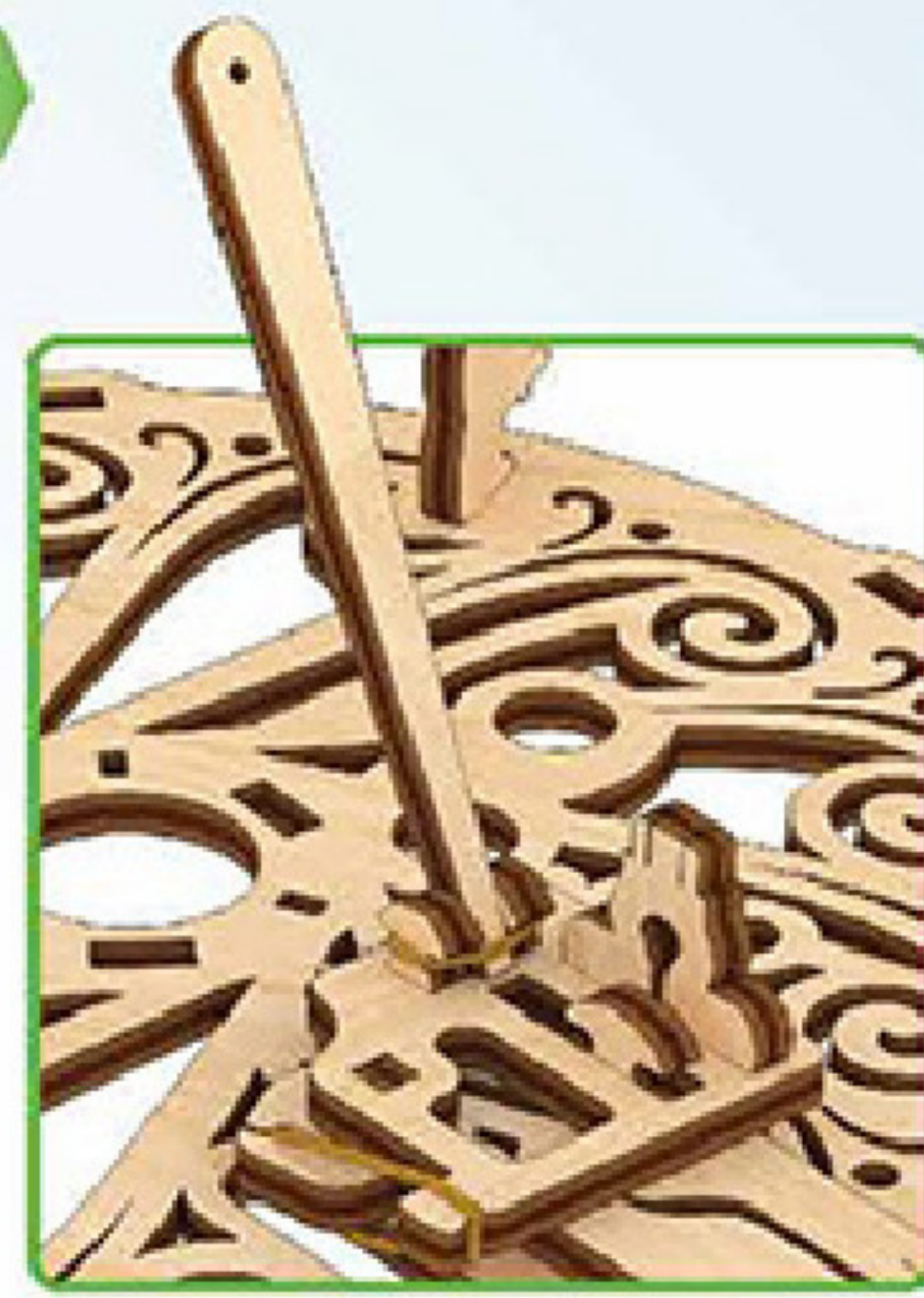

10





Mechanical models

1

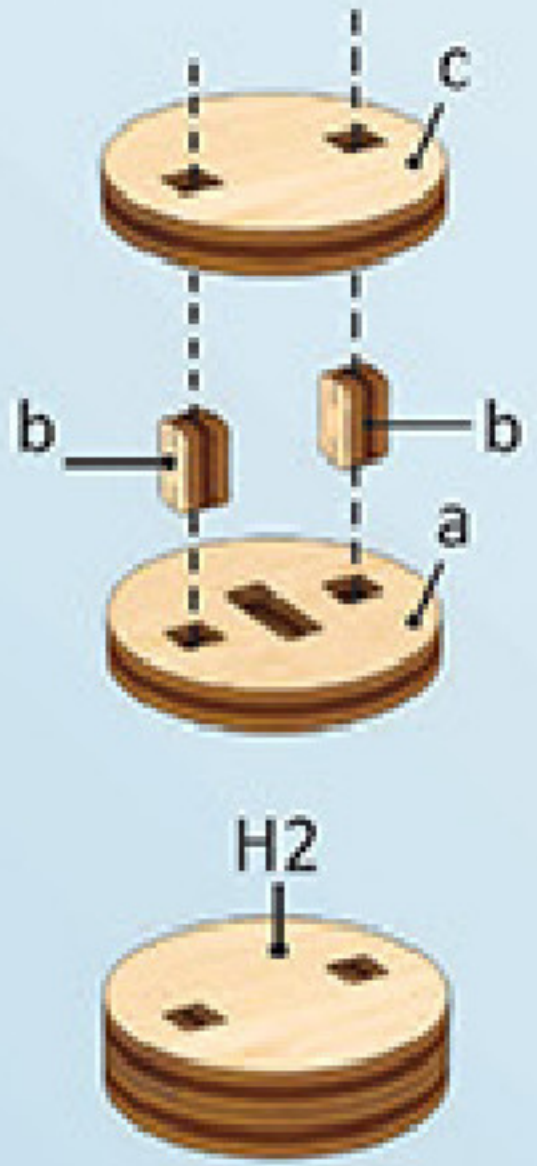

2

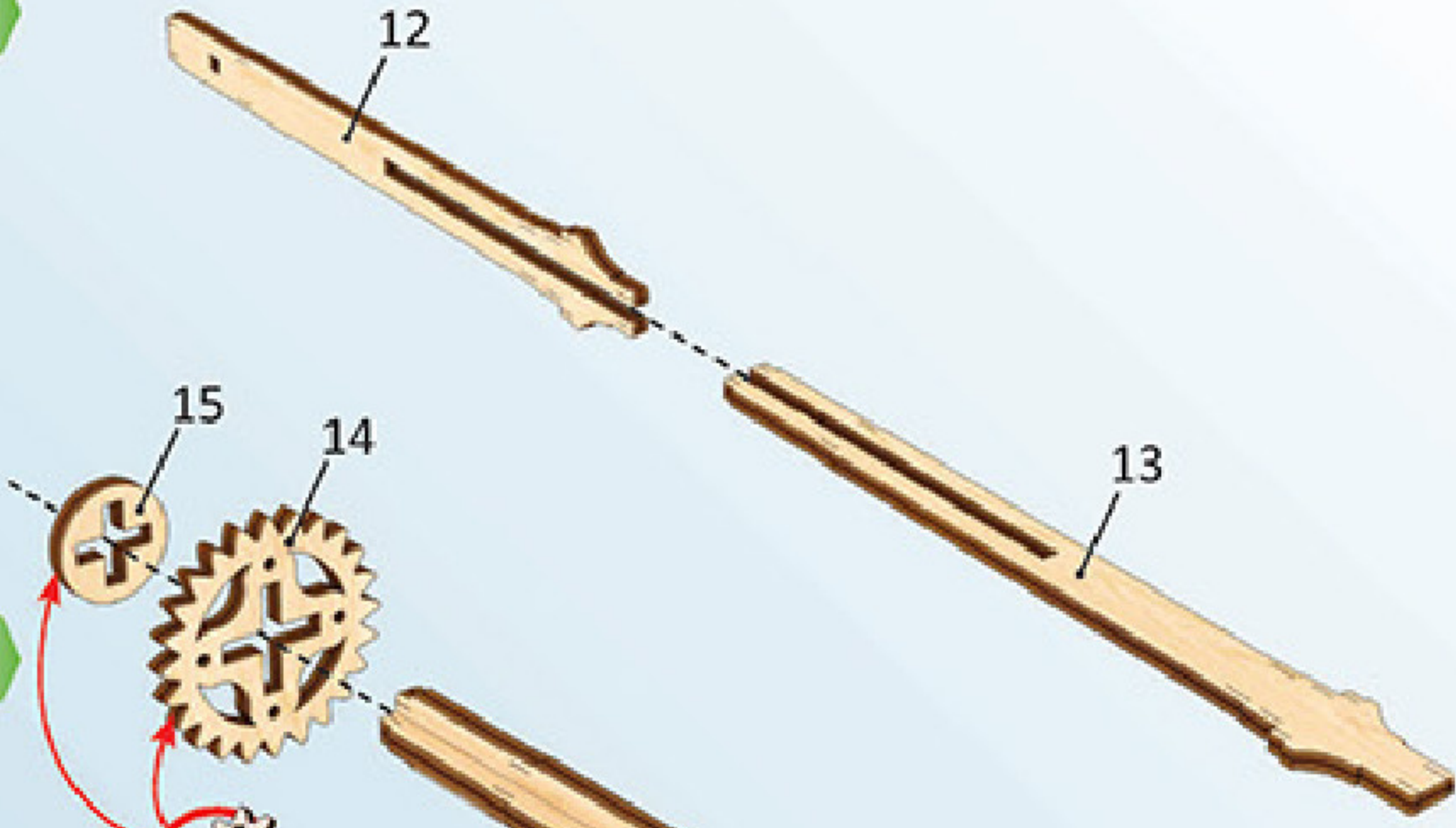

3

4

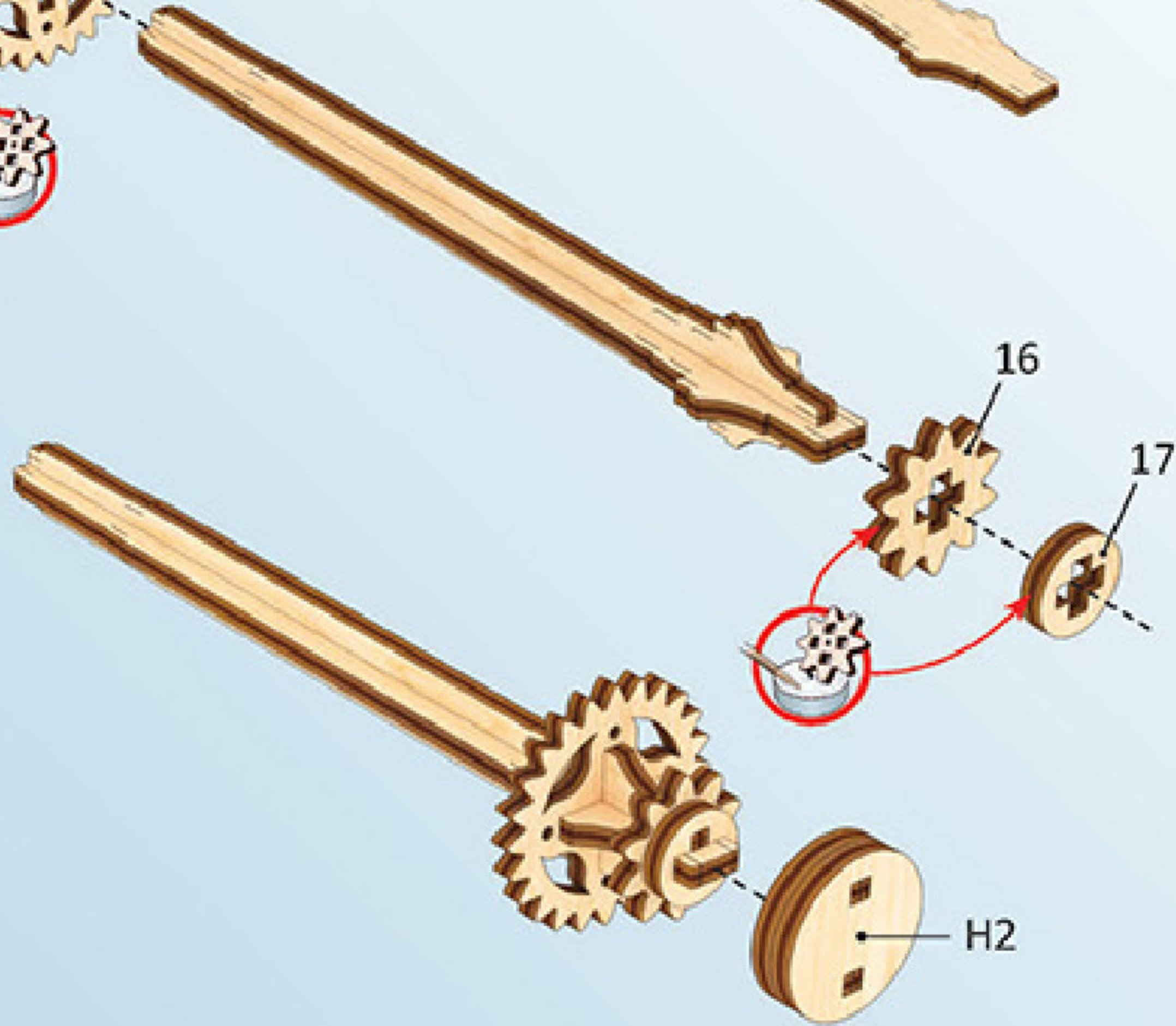

5



6

1

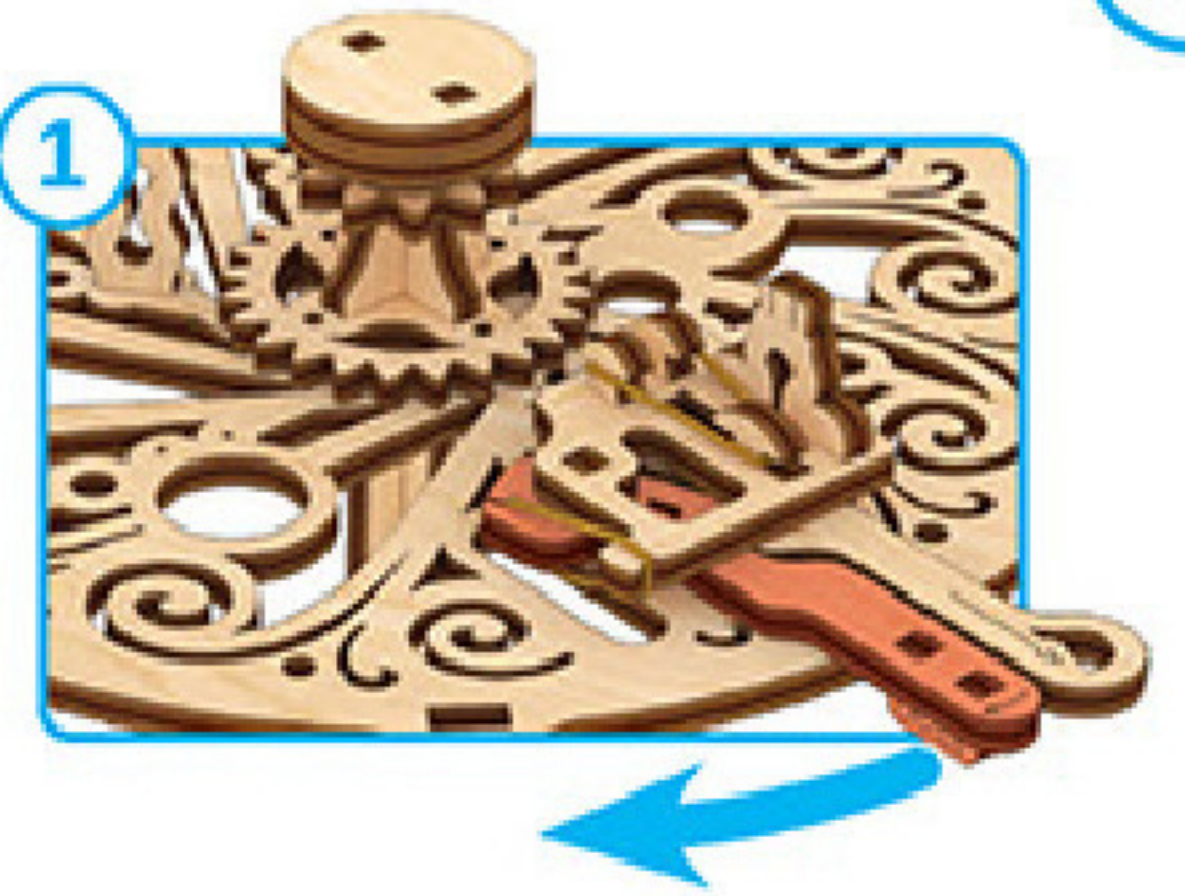

2

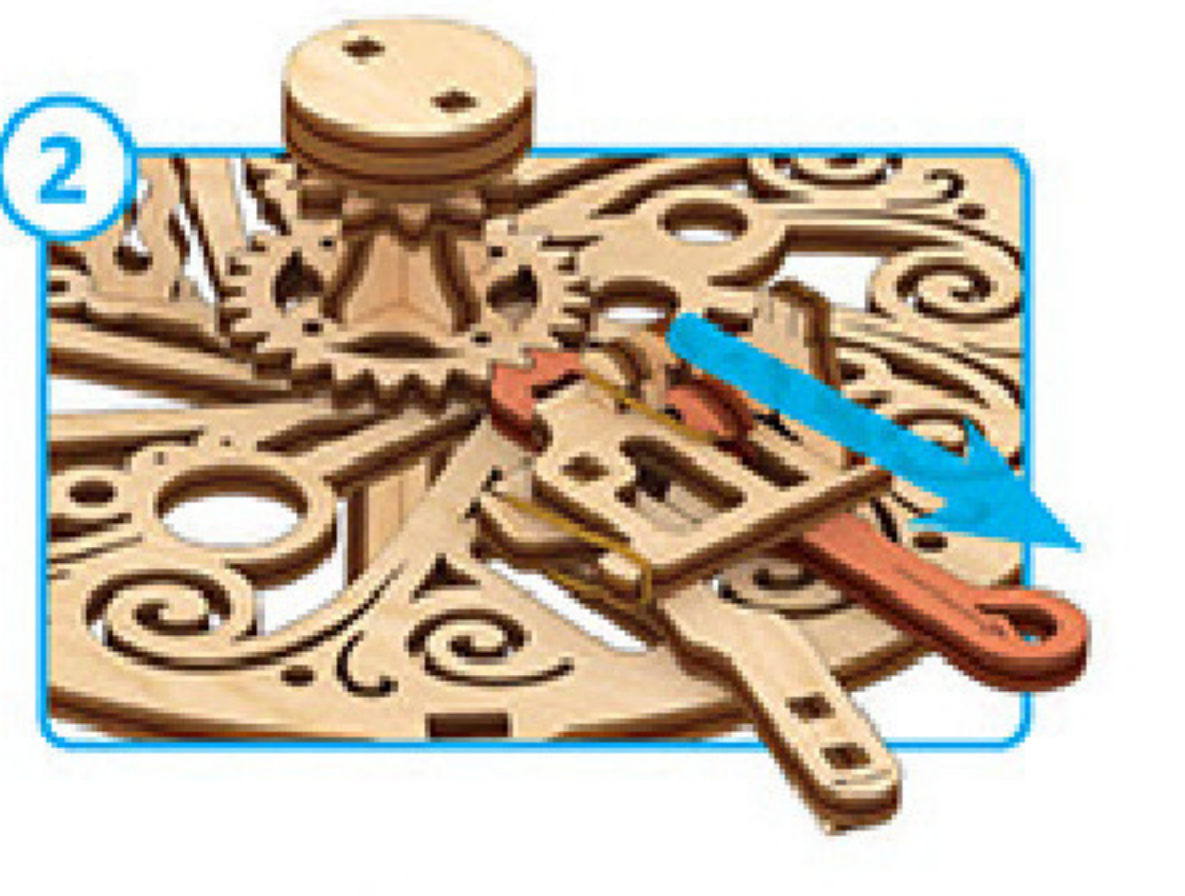

3

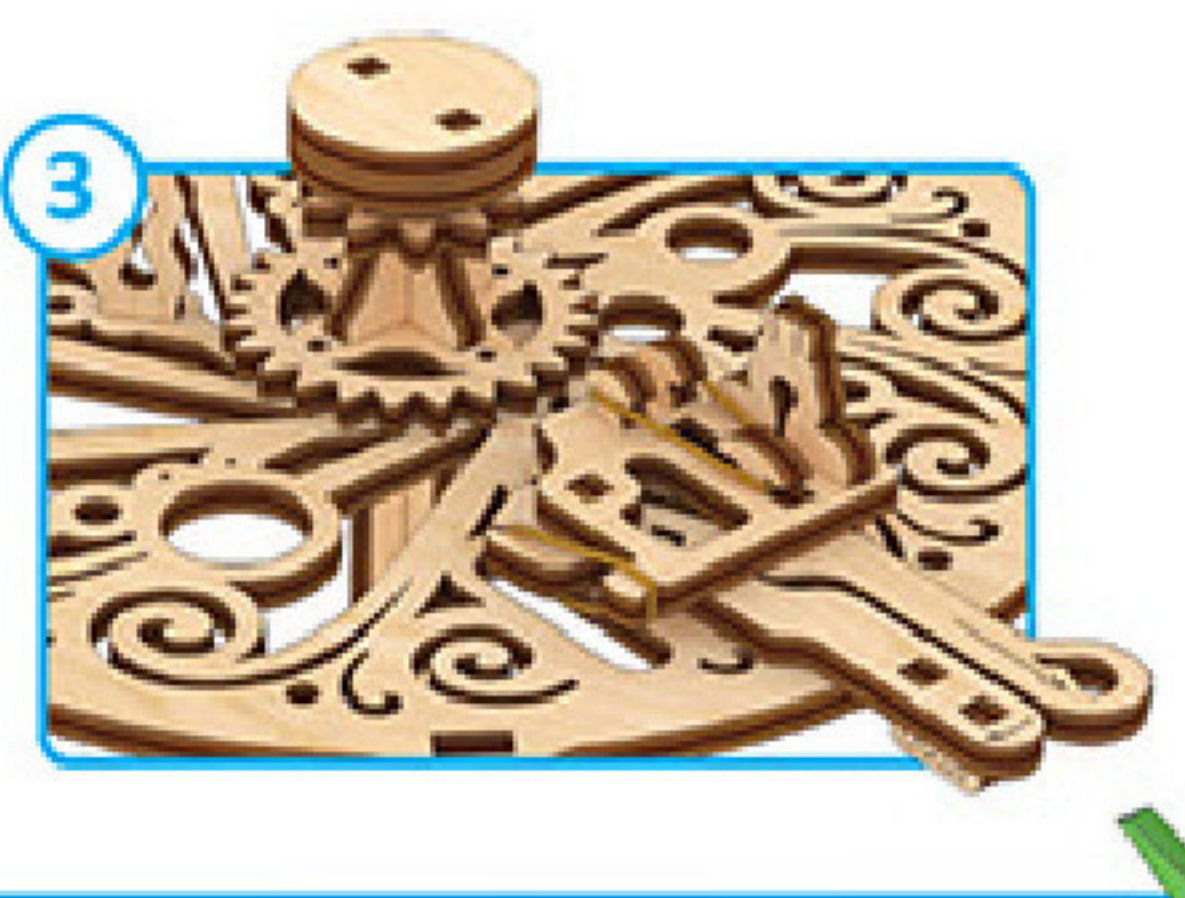

6

1





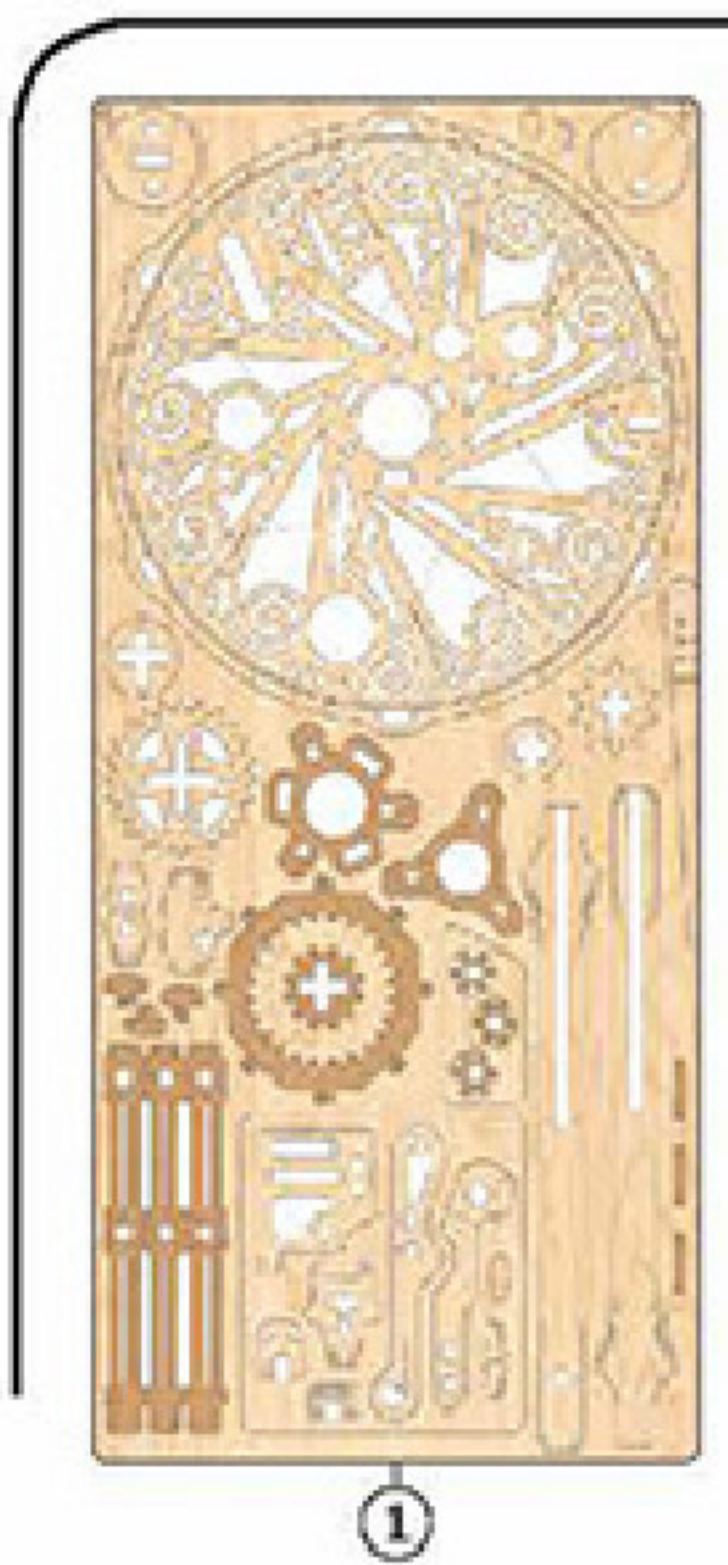

1

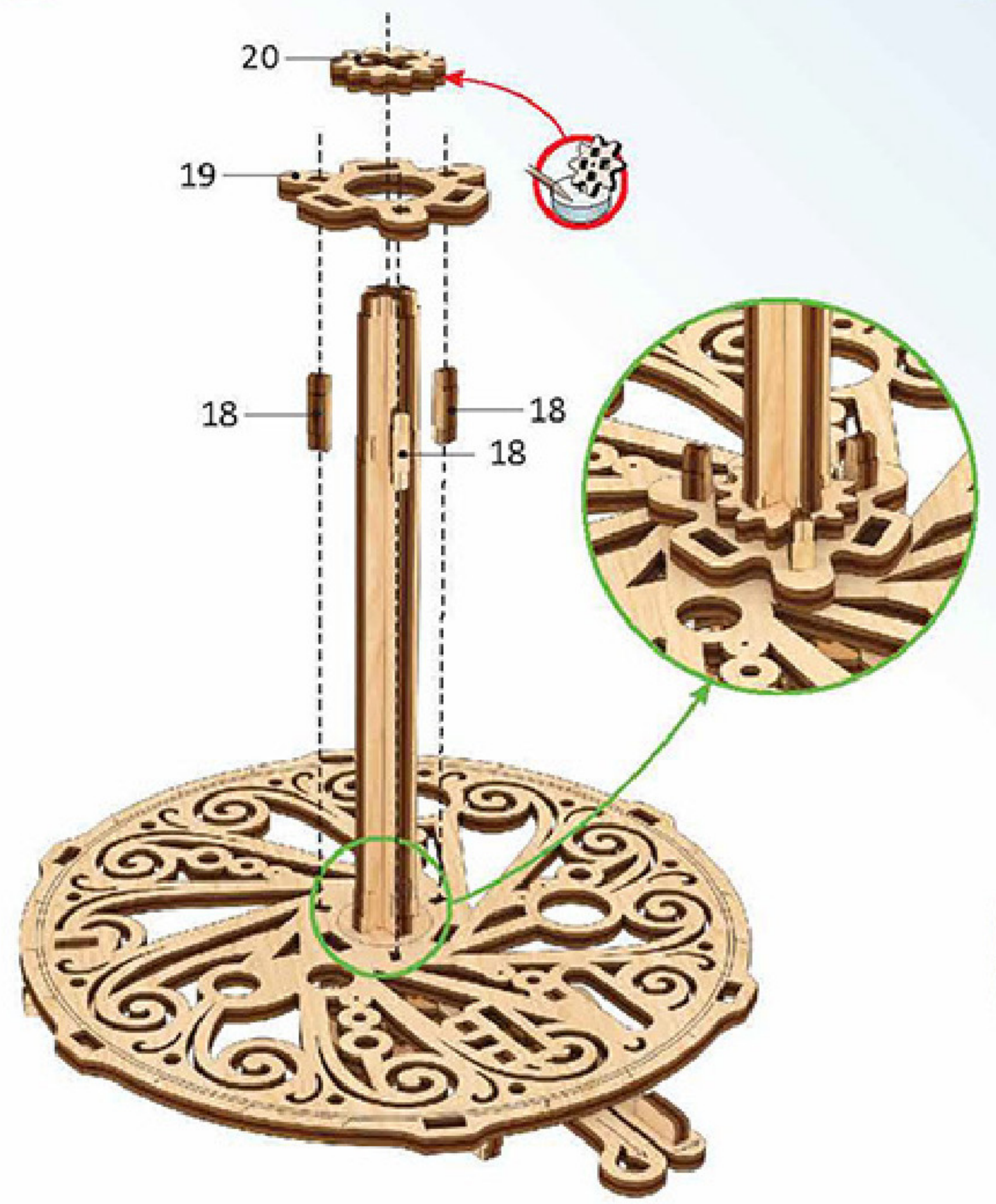

2

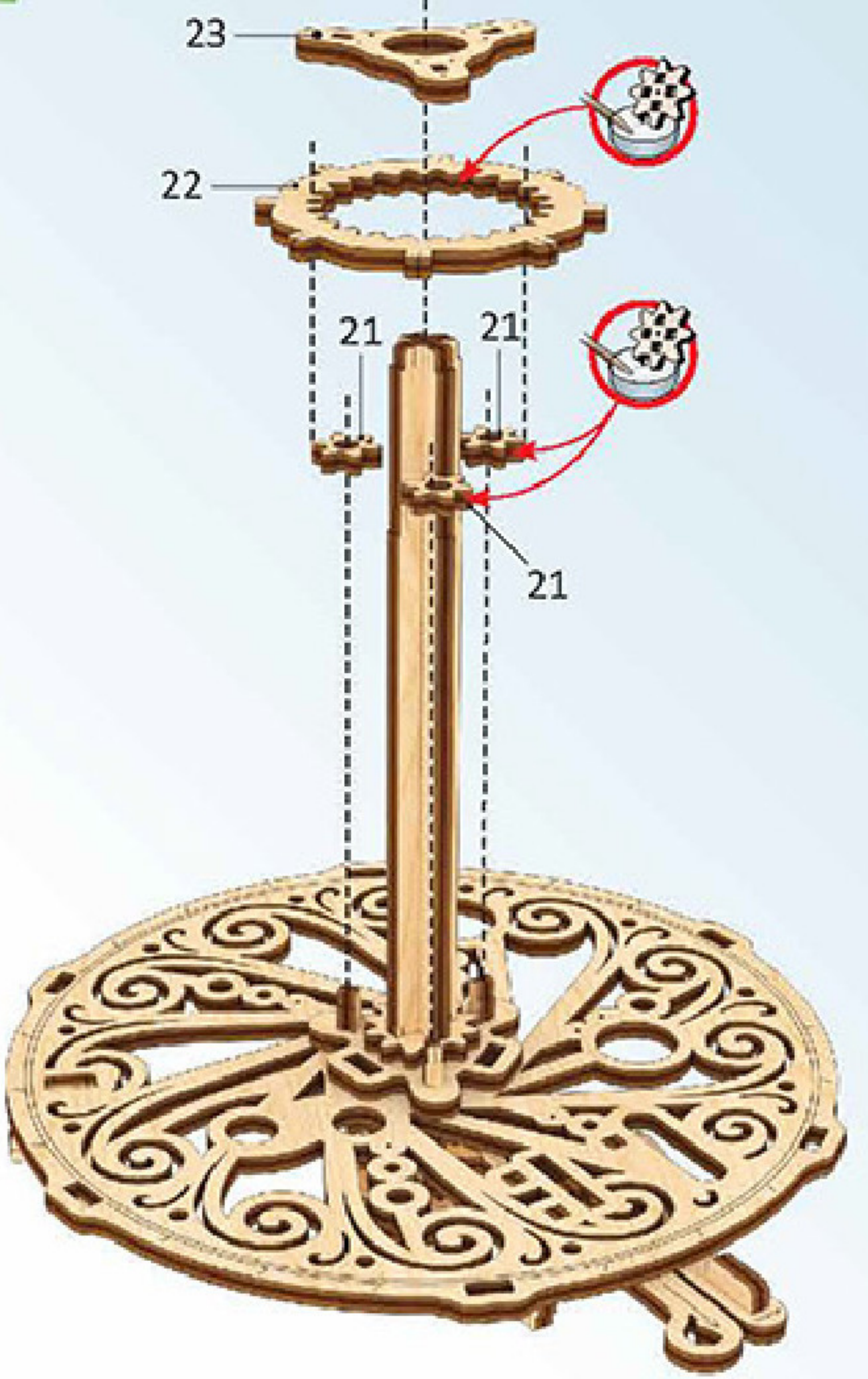



1



2

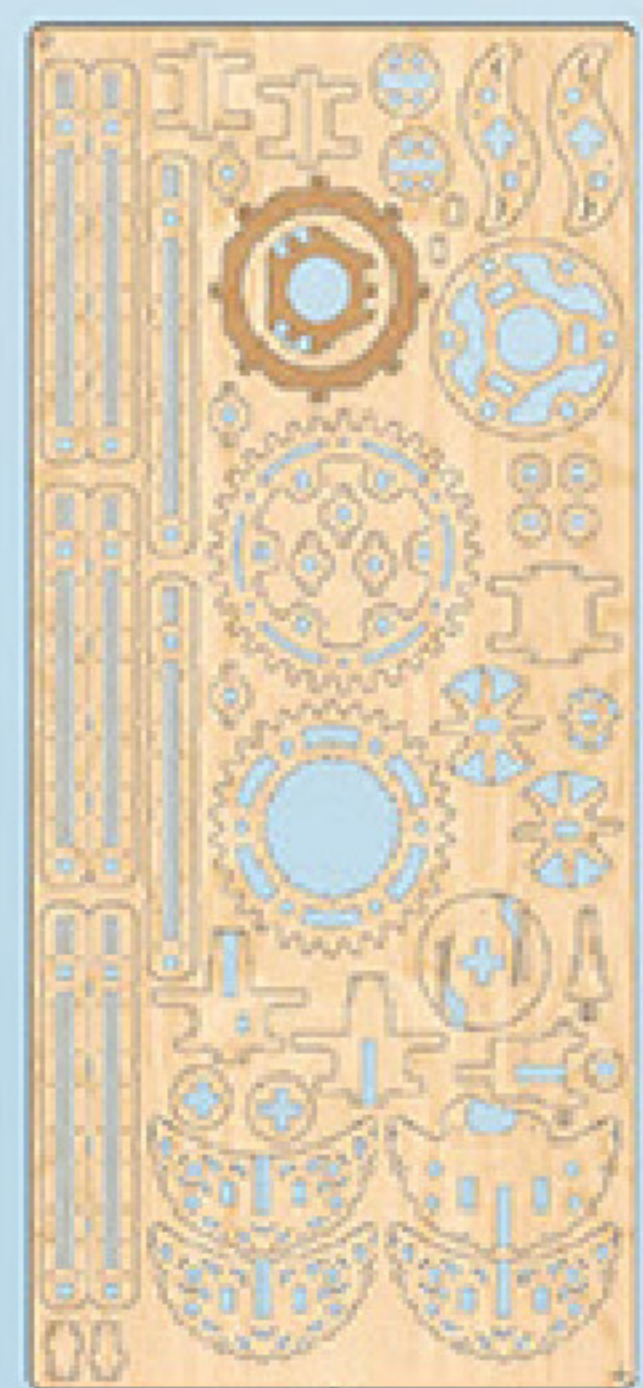
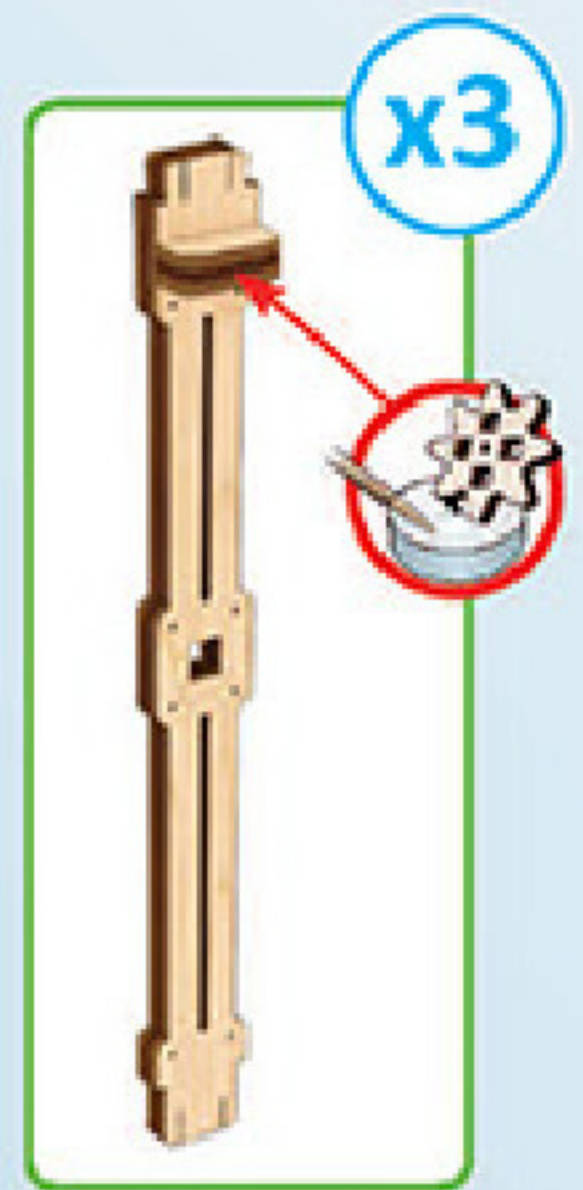

8

3

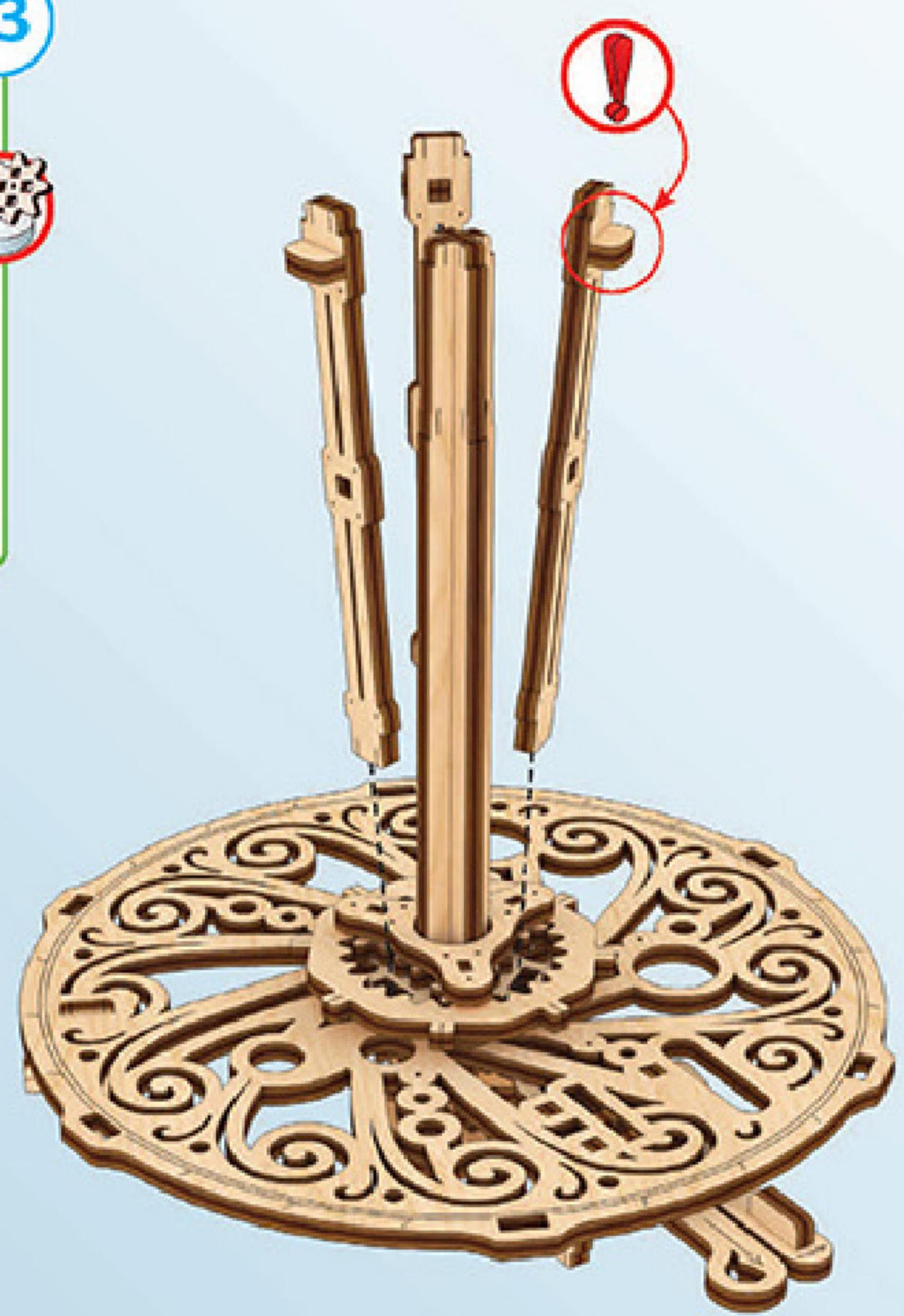

4

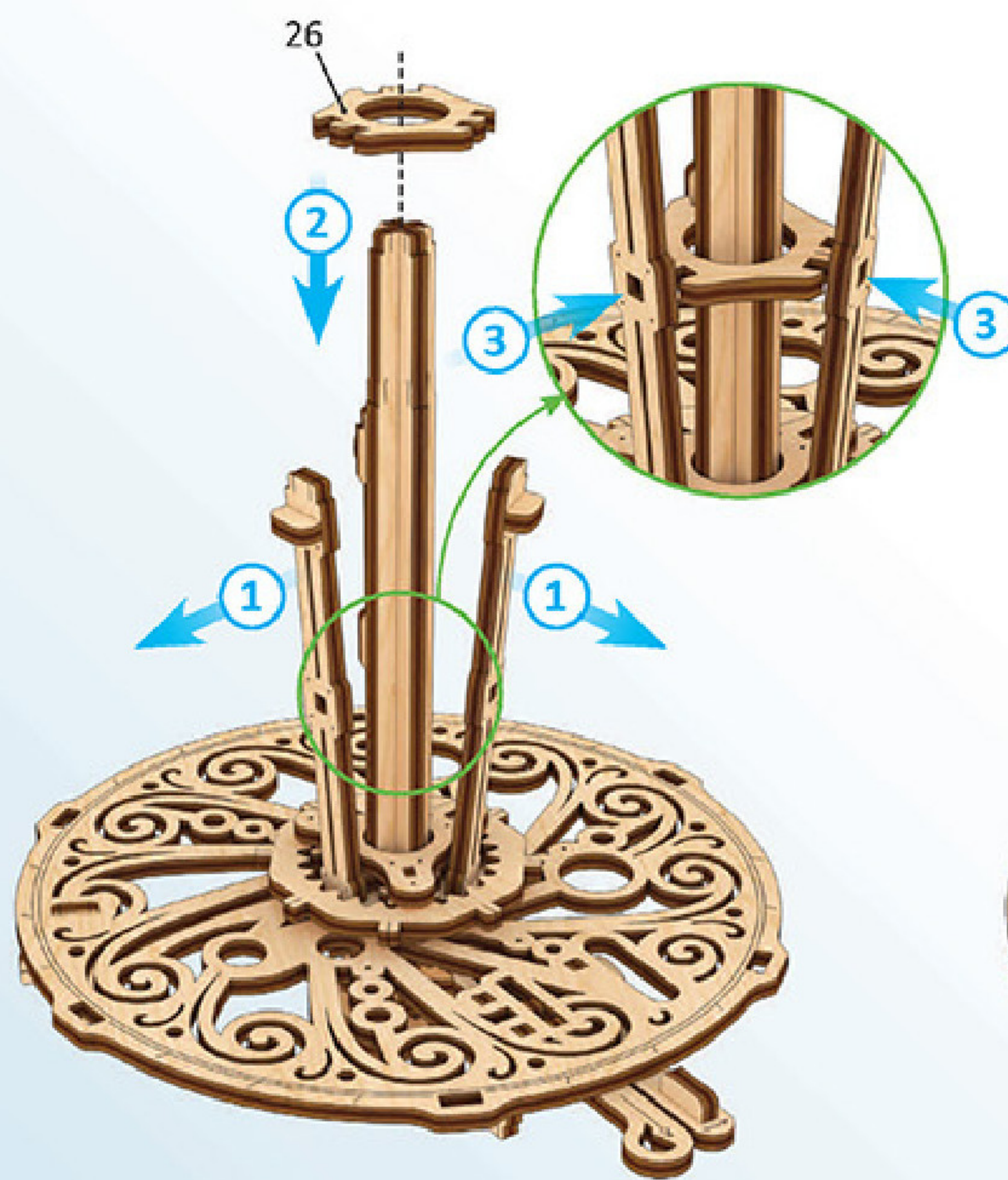



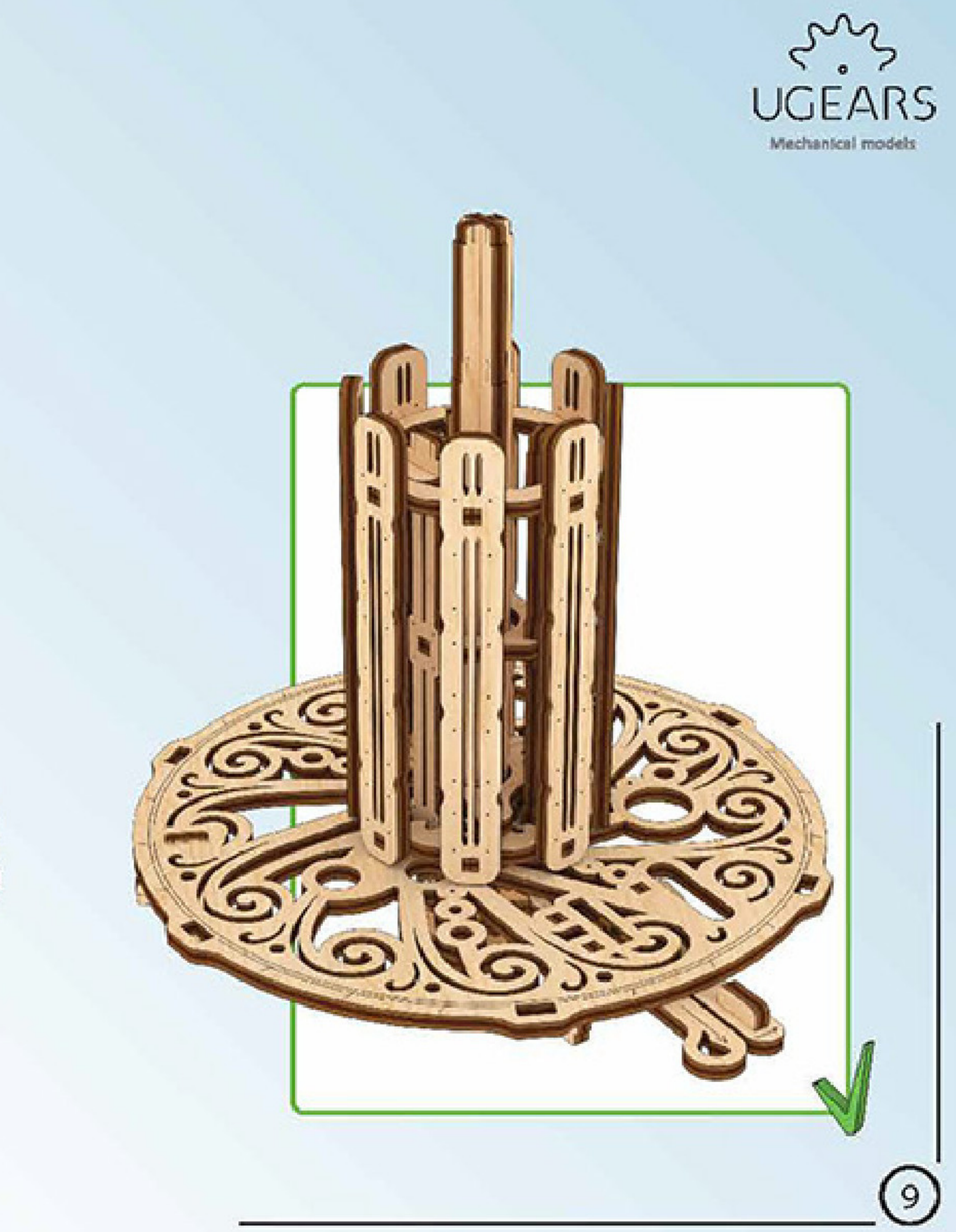
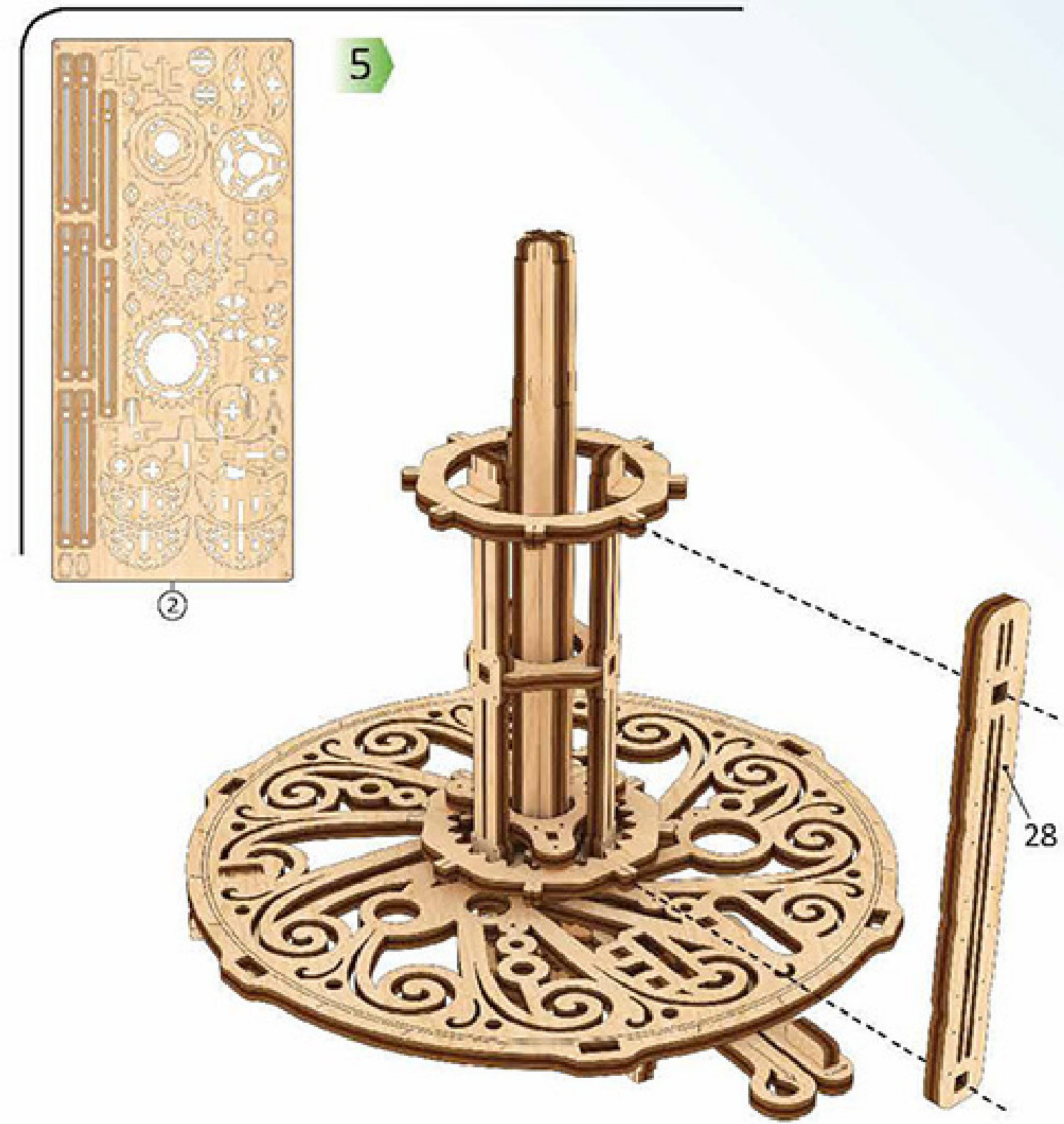



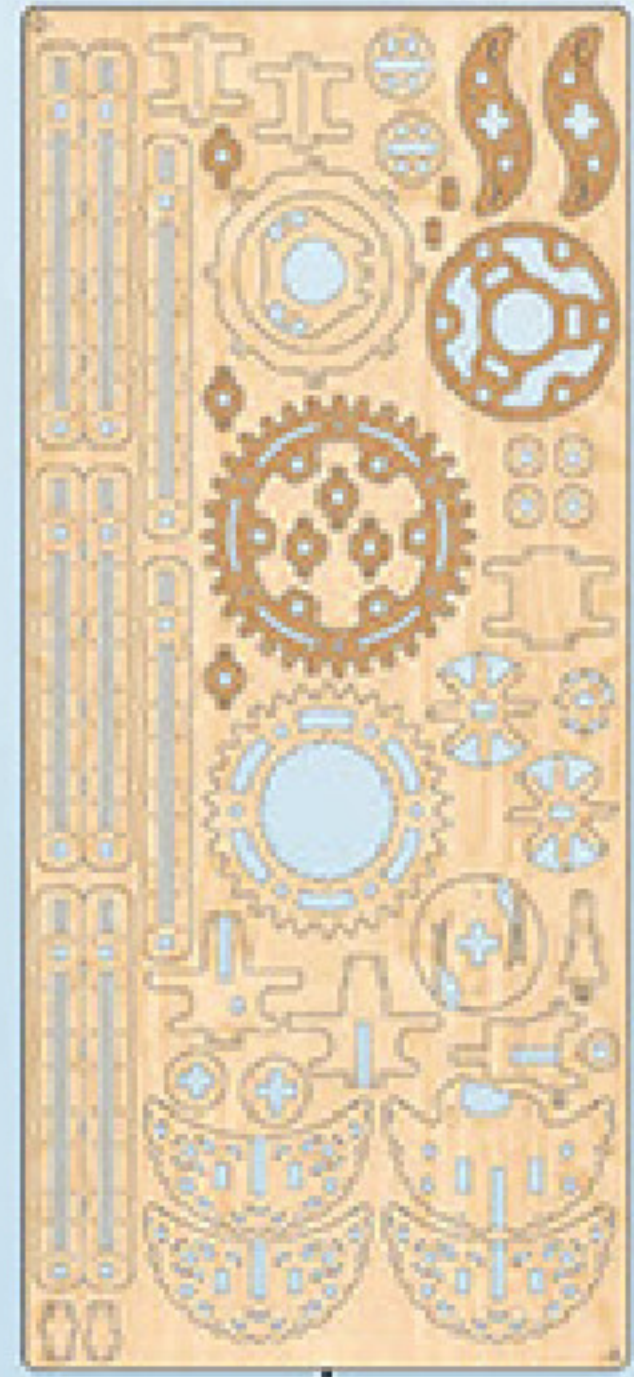

1

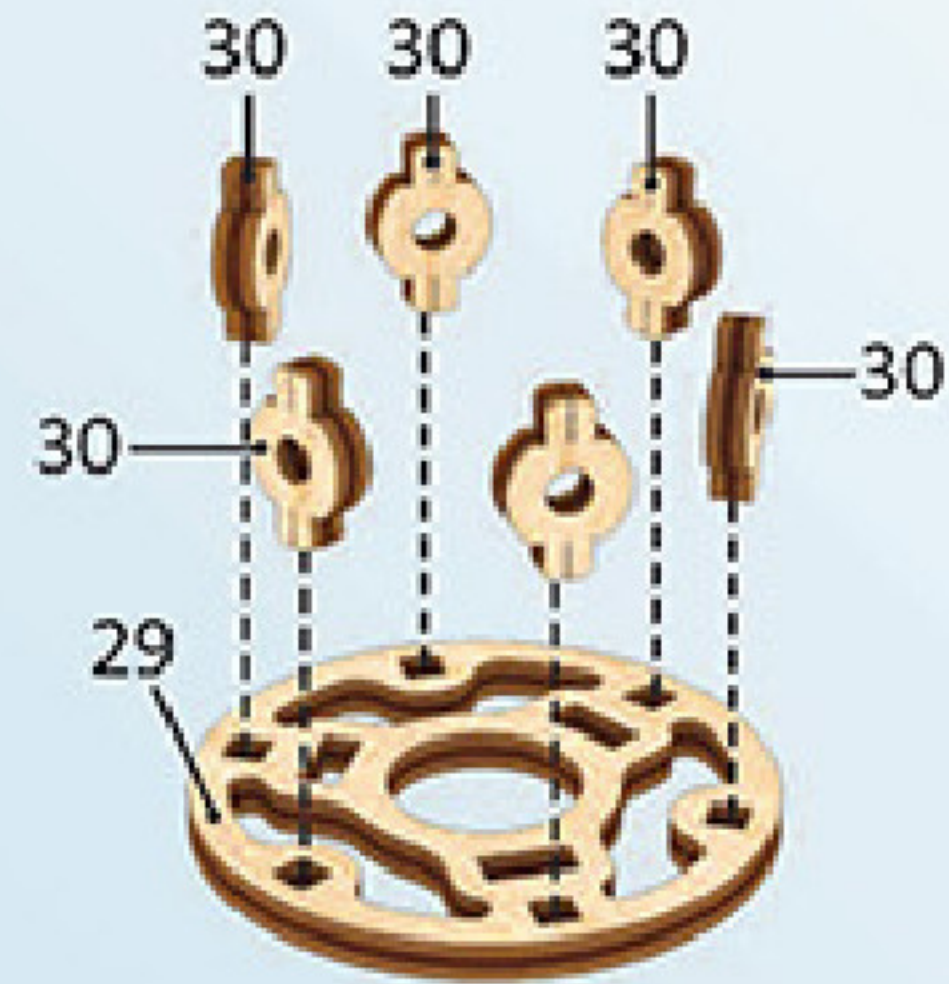

2

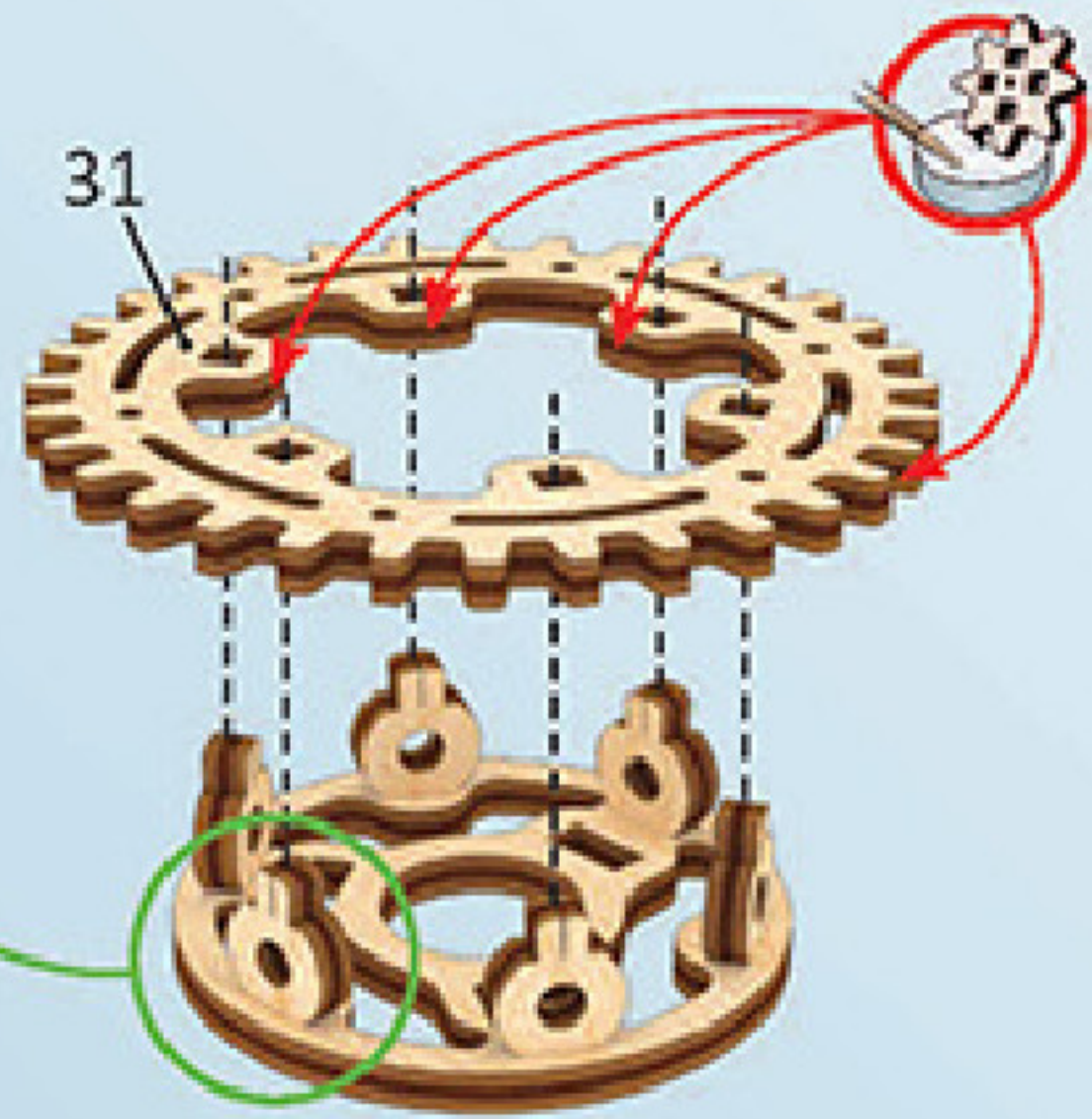

3

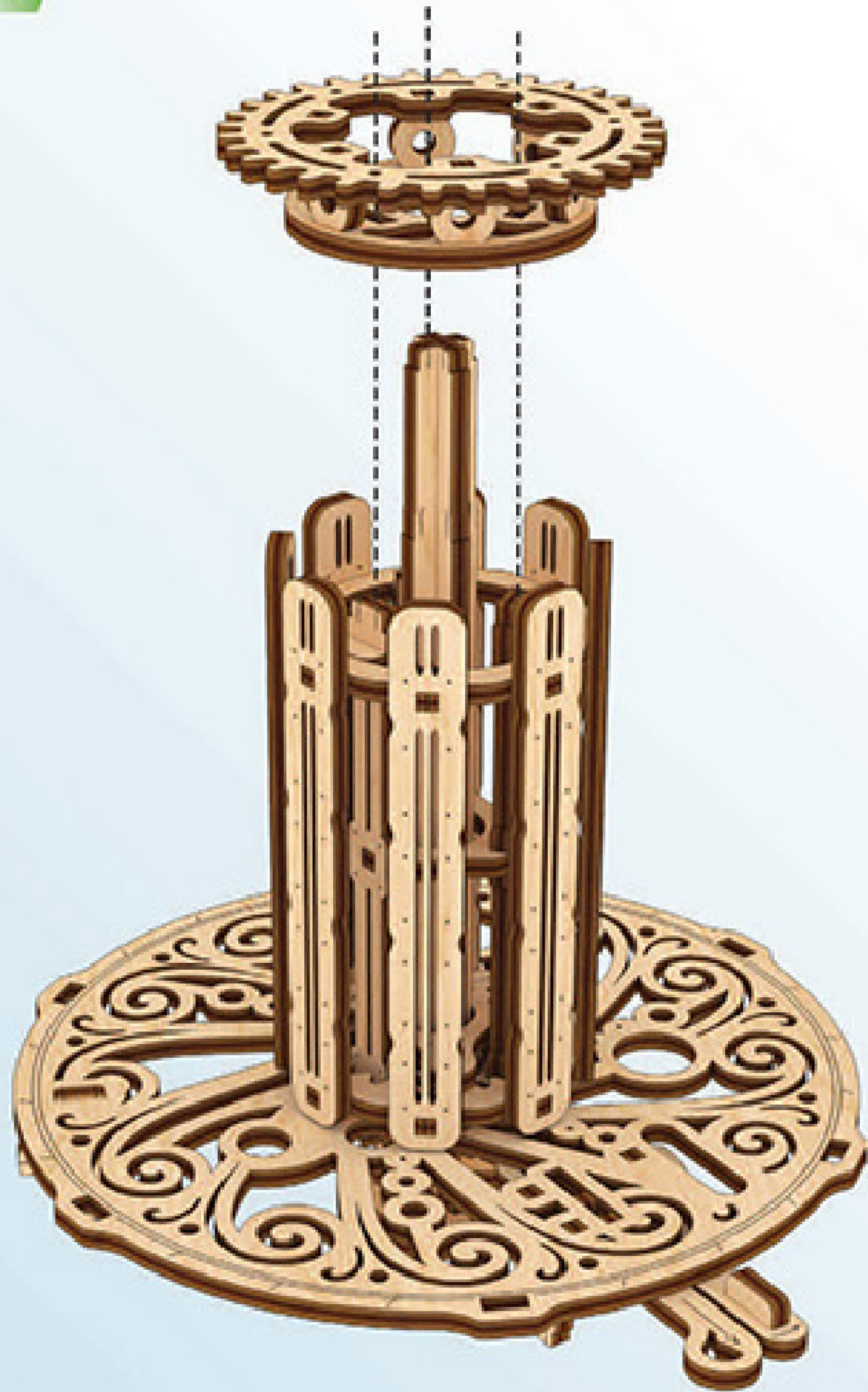

1

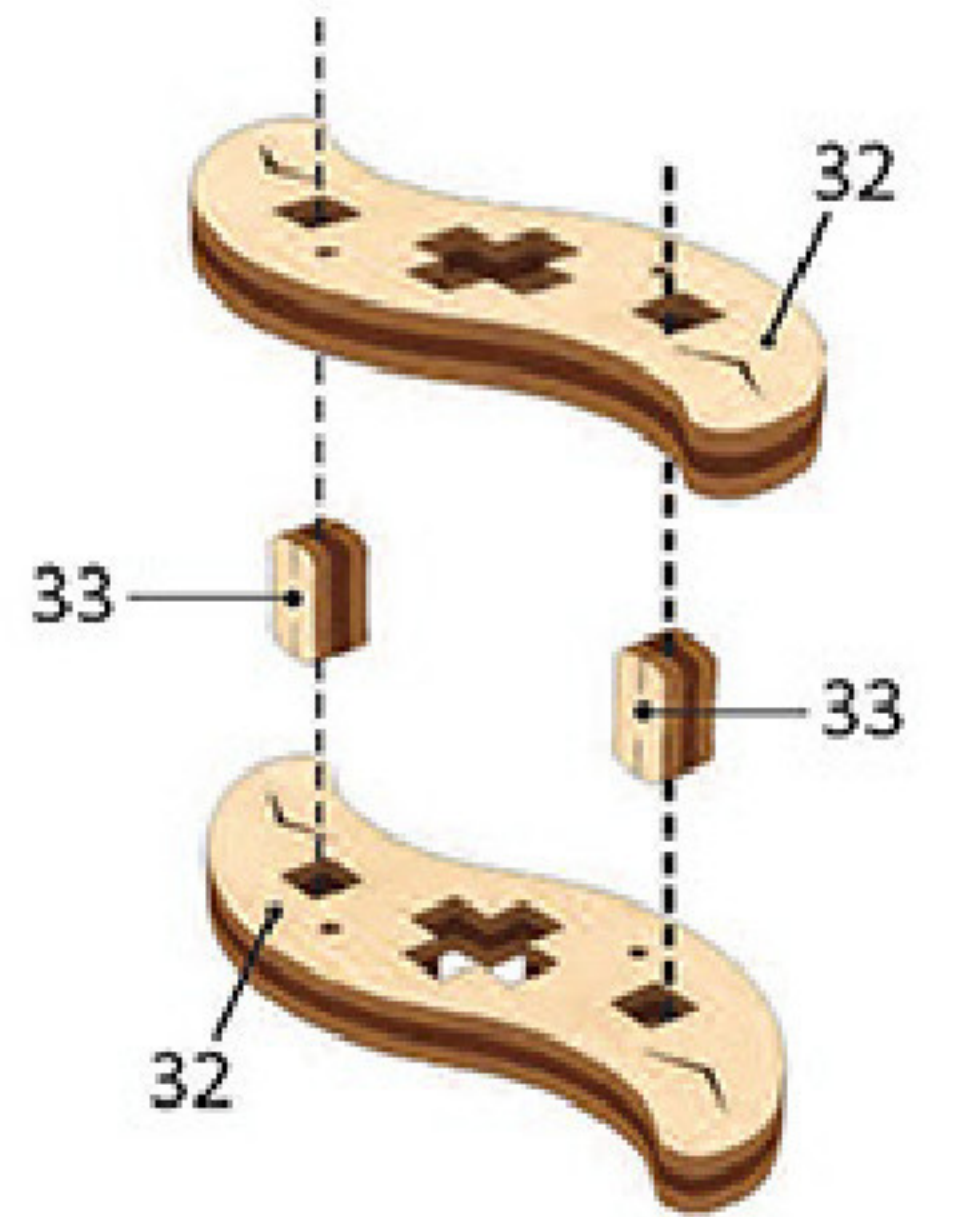

D

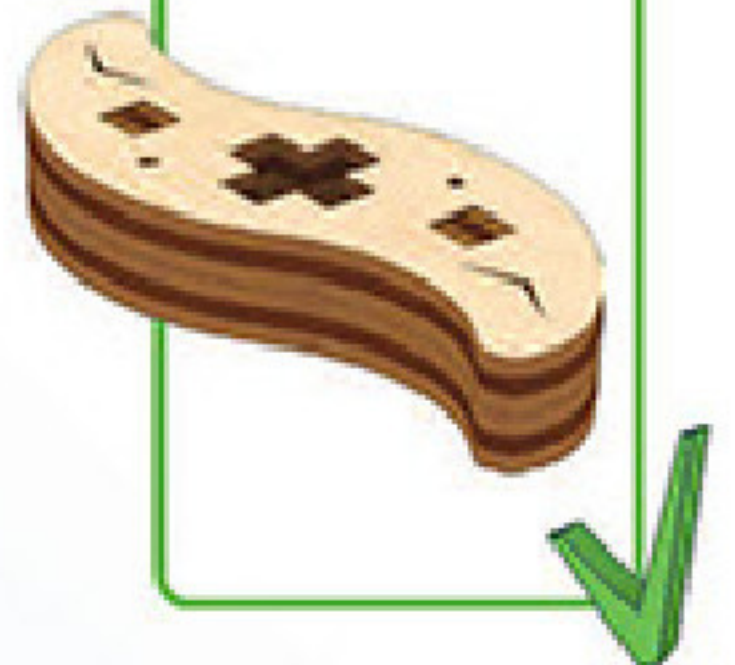



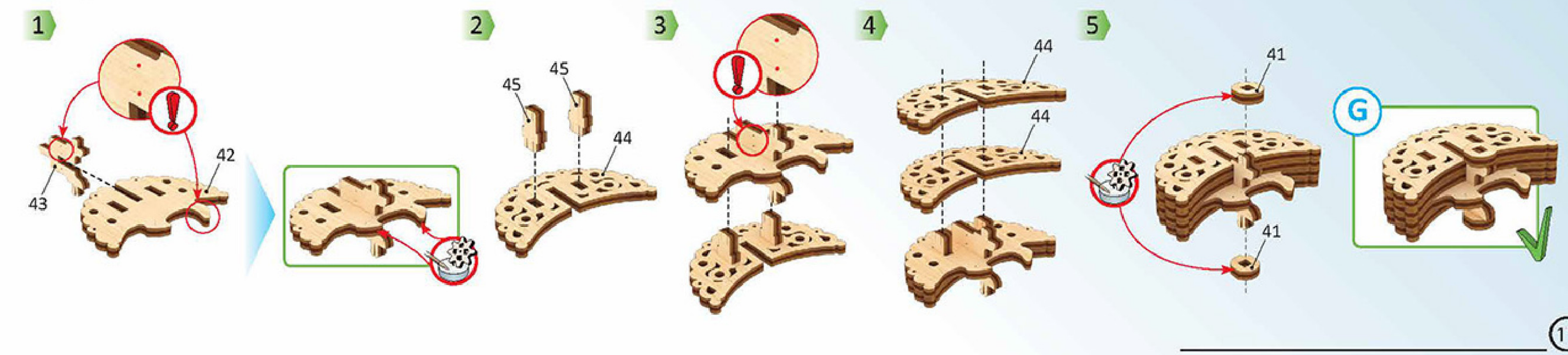
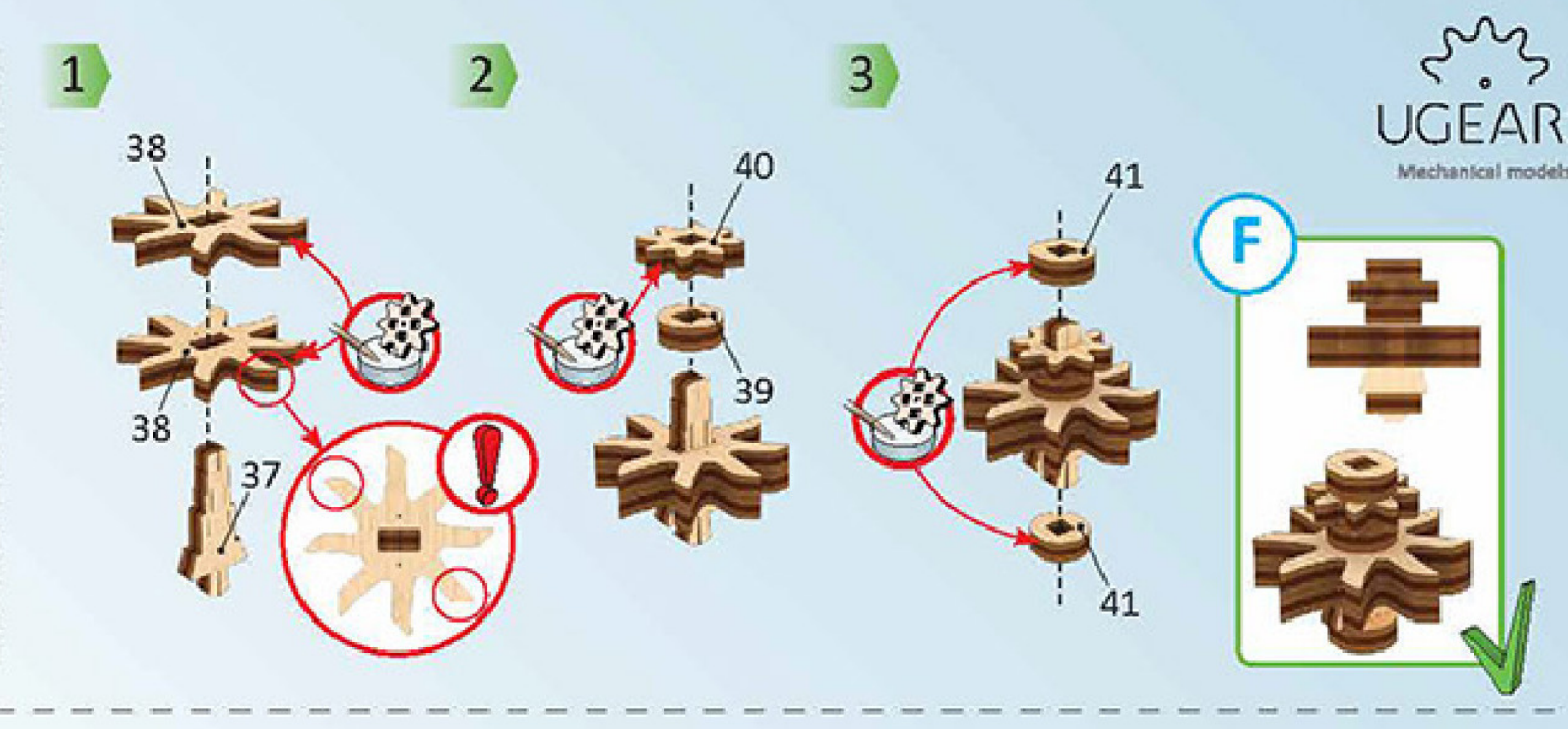
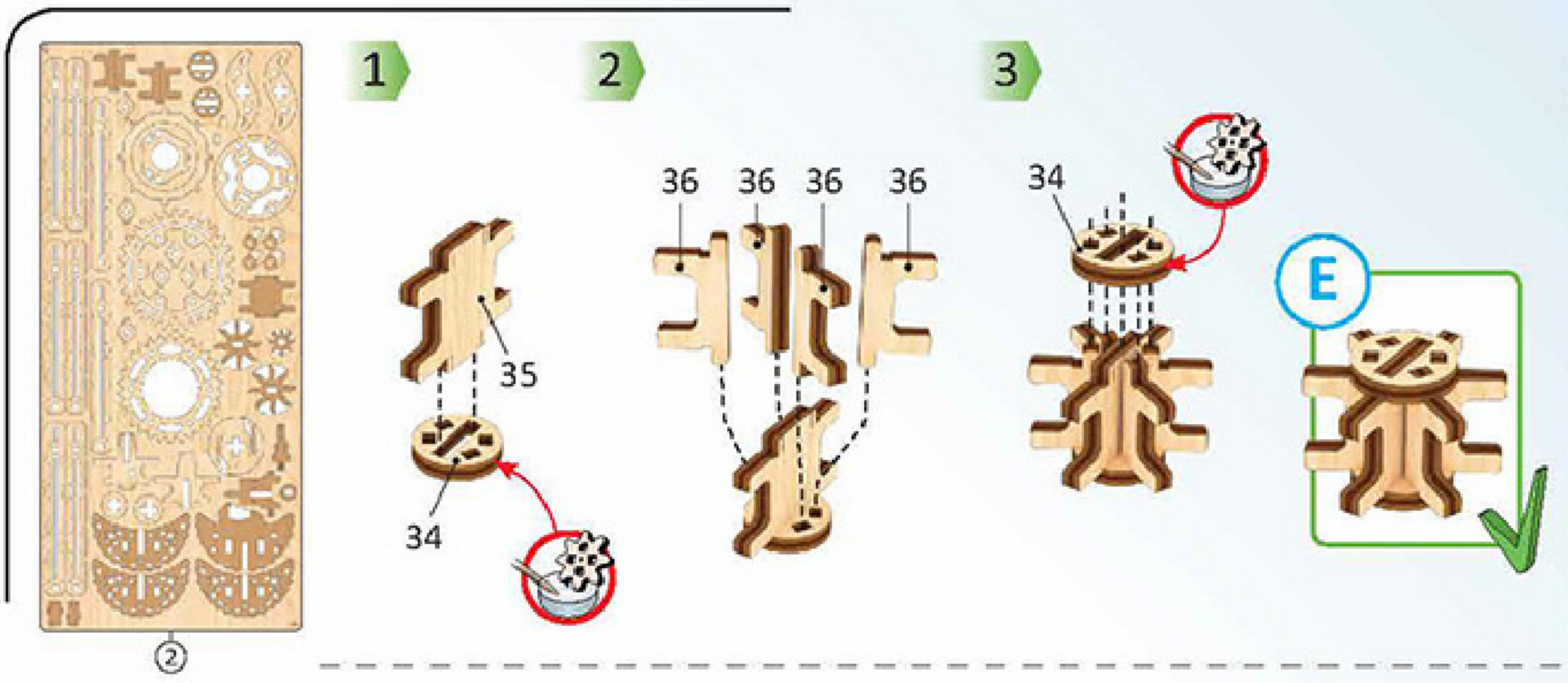



Mechanical models



1



2

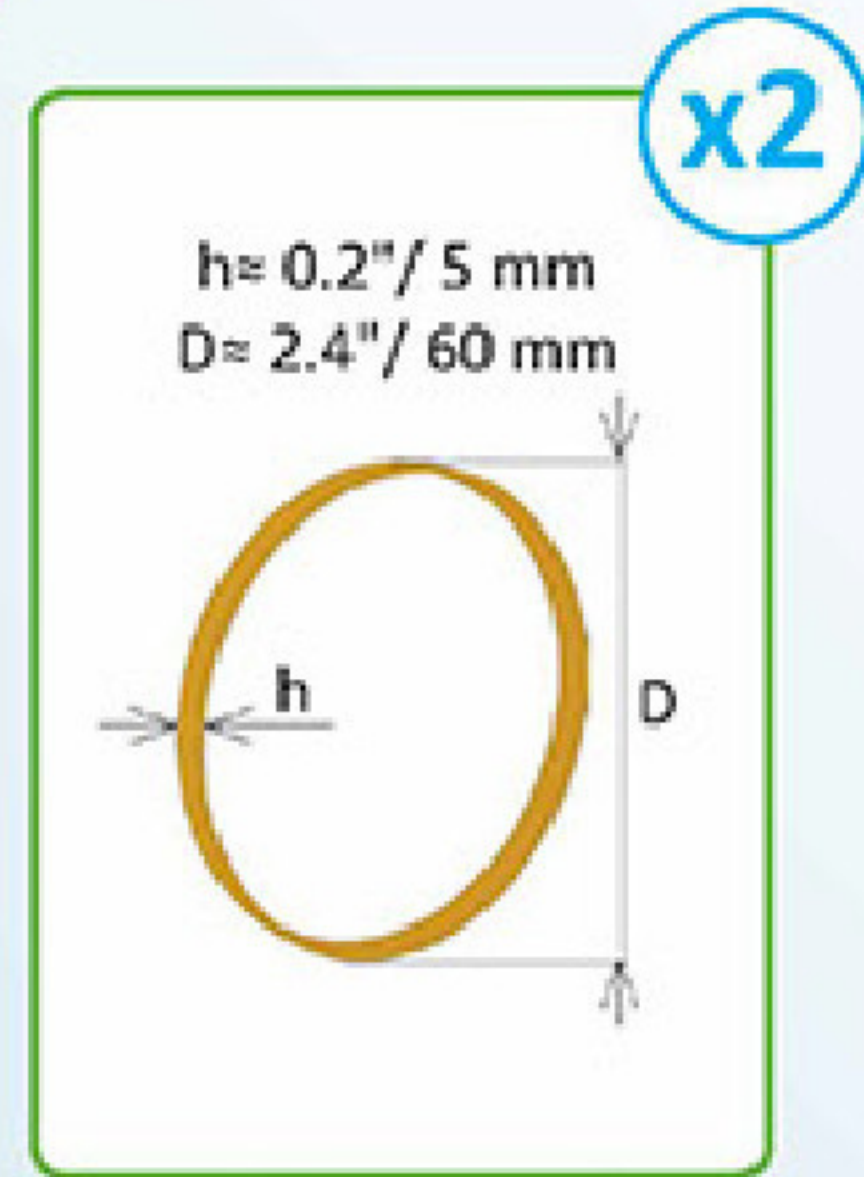

3



4



5

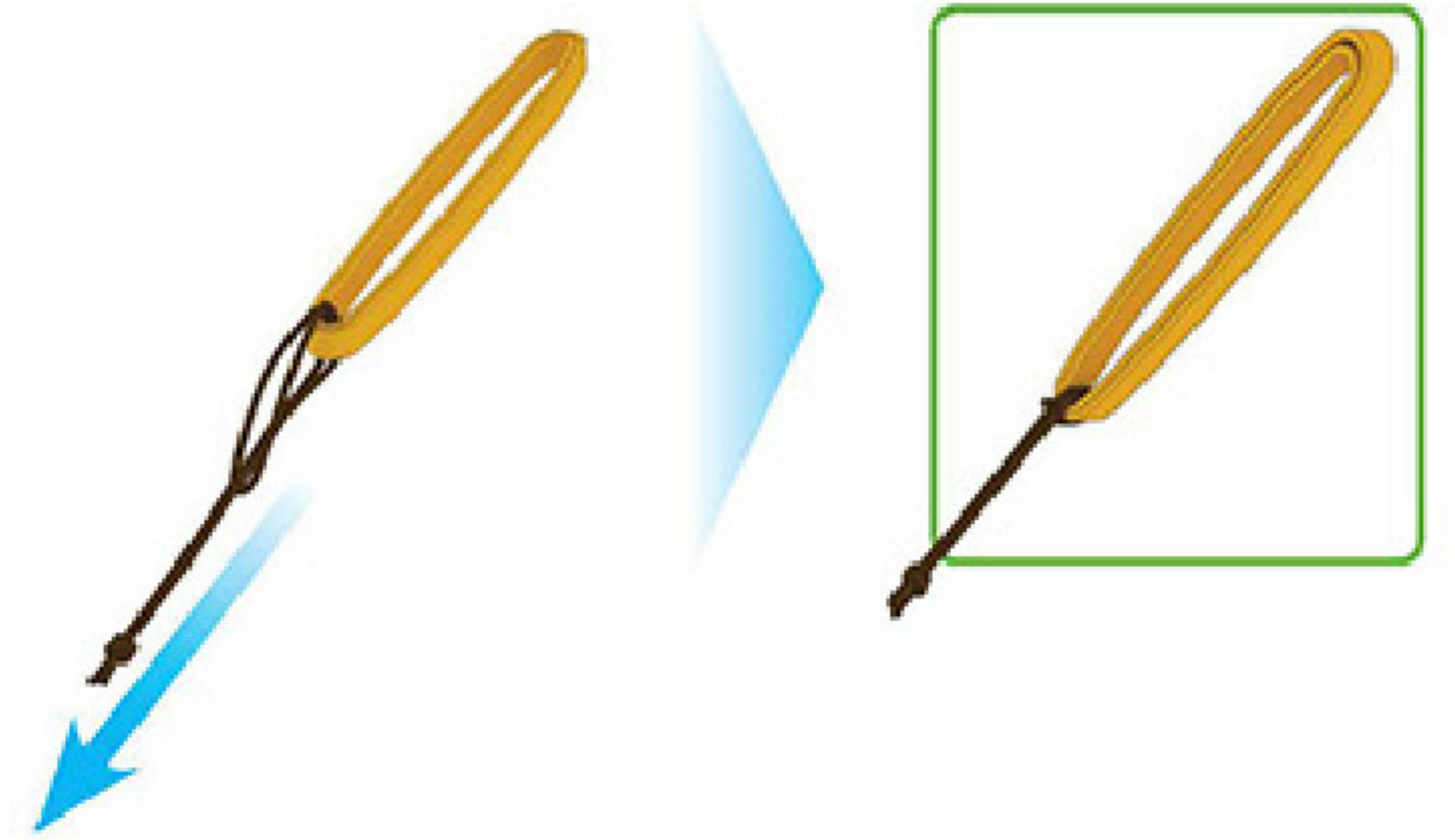

6

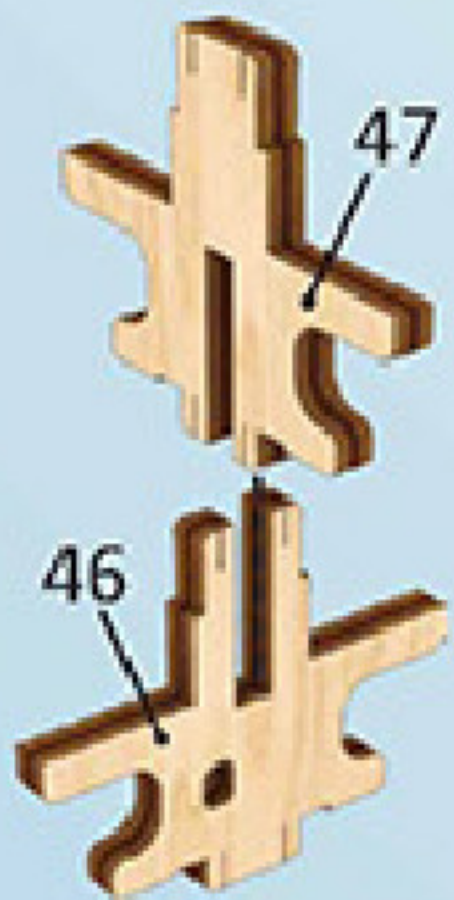

7

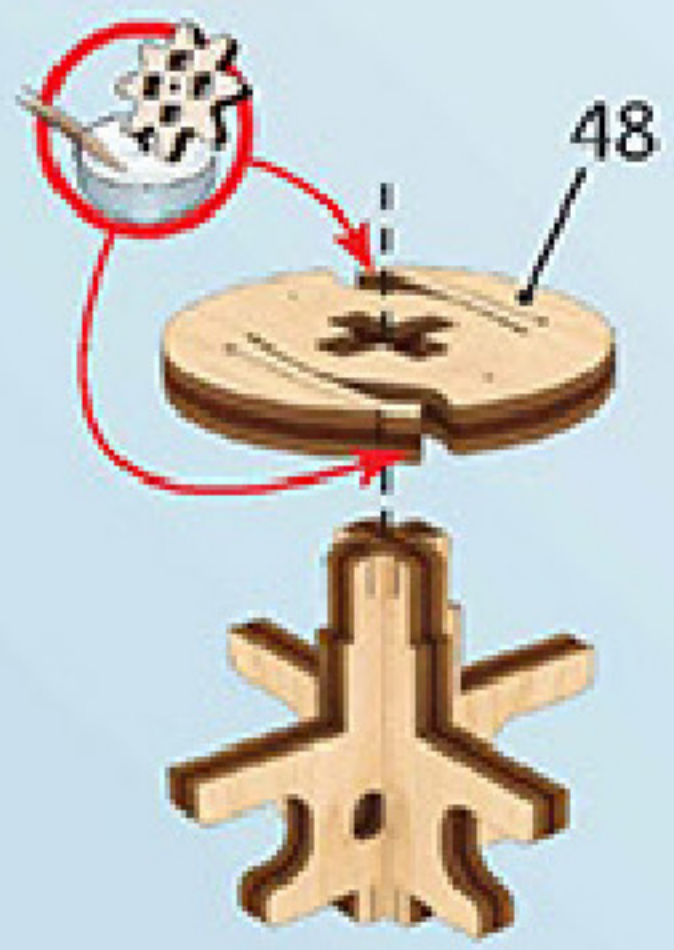

8

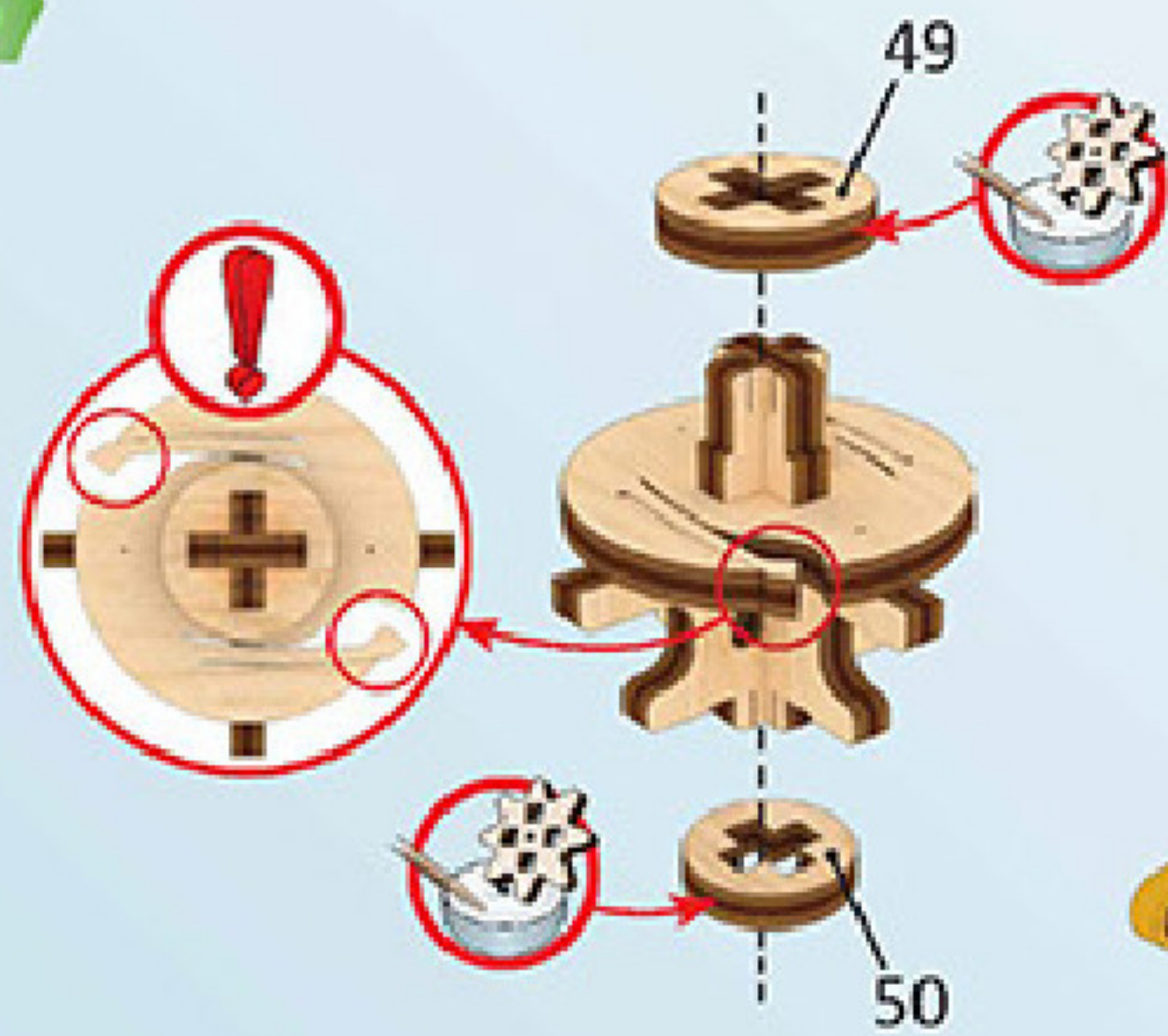

9

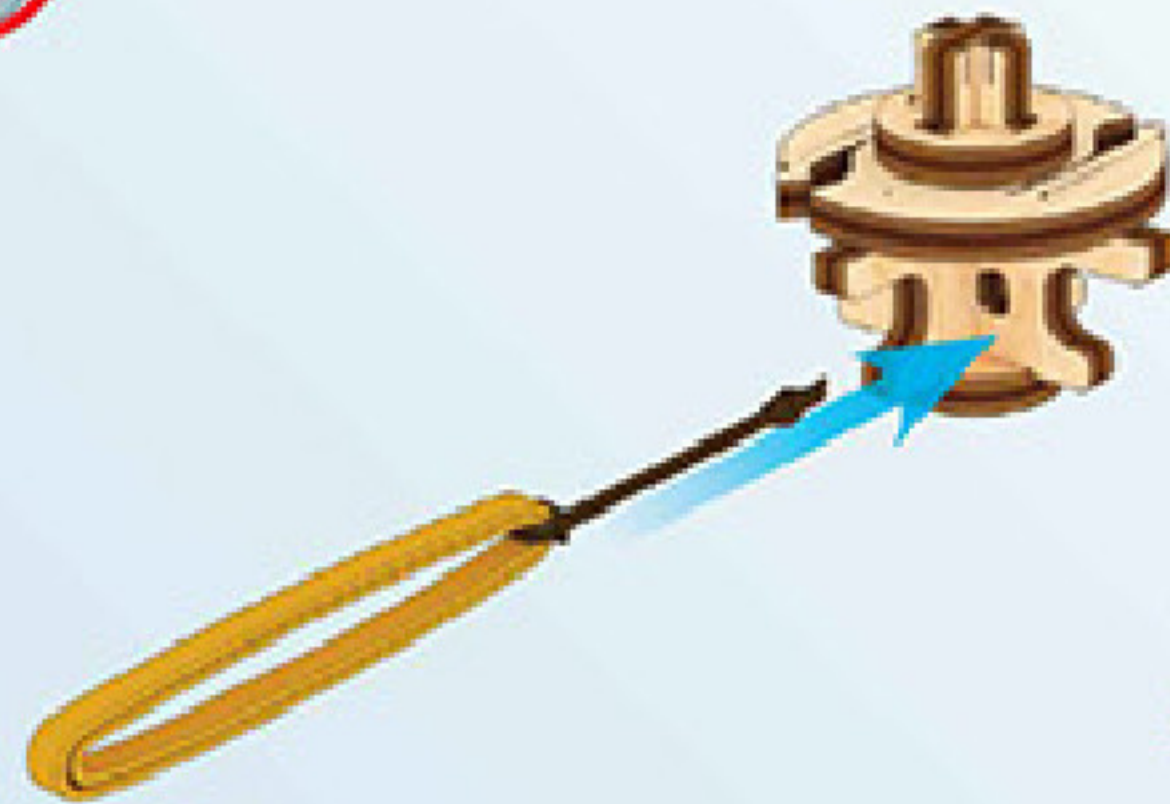

10

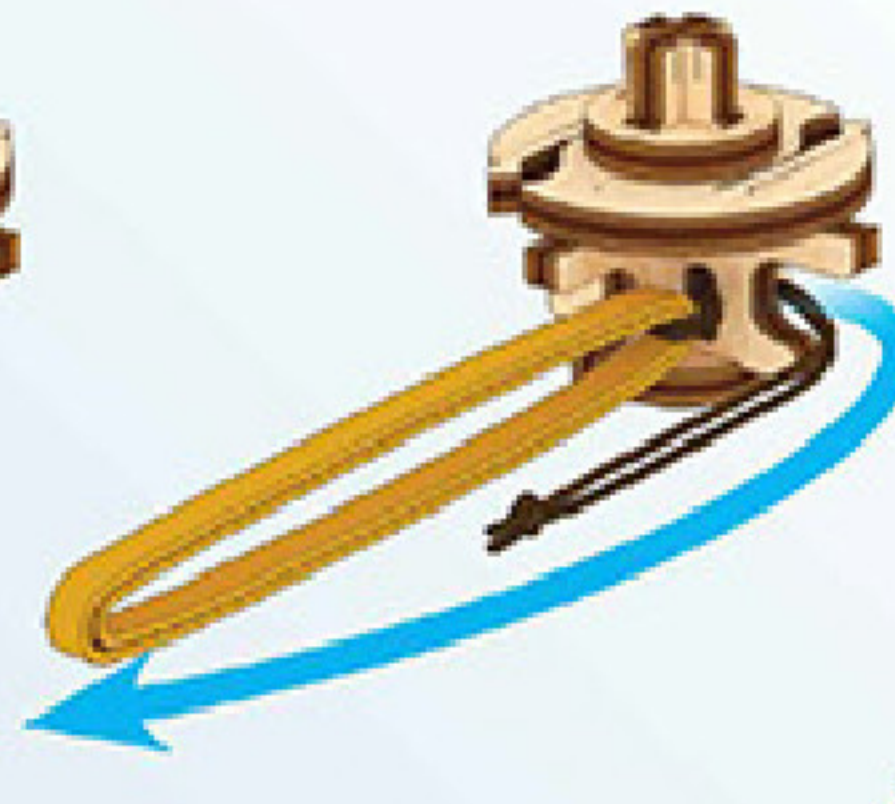

11

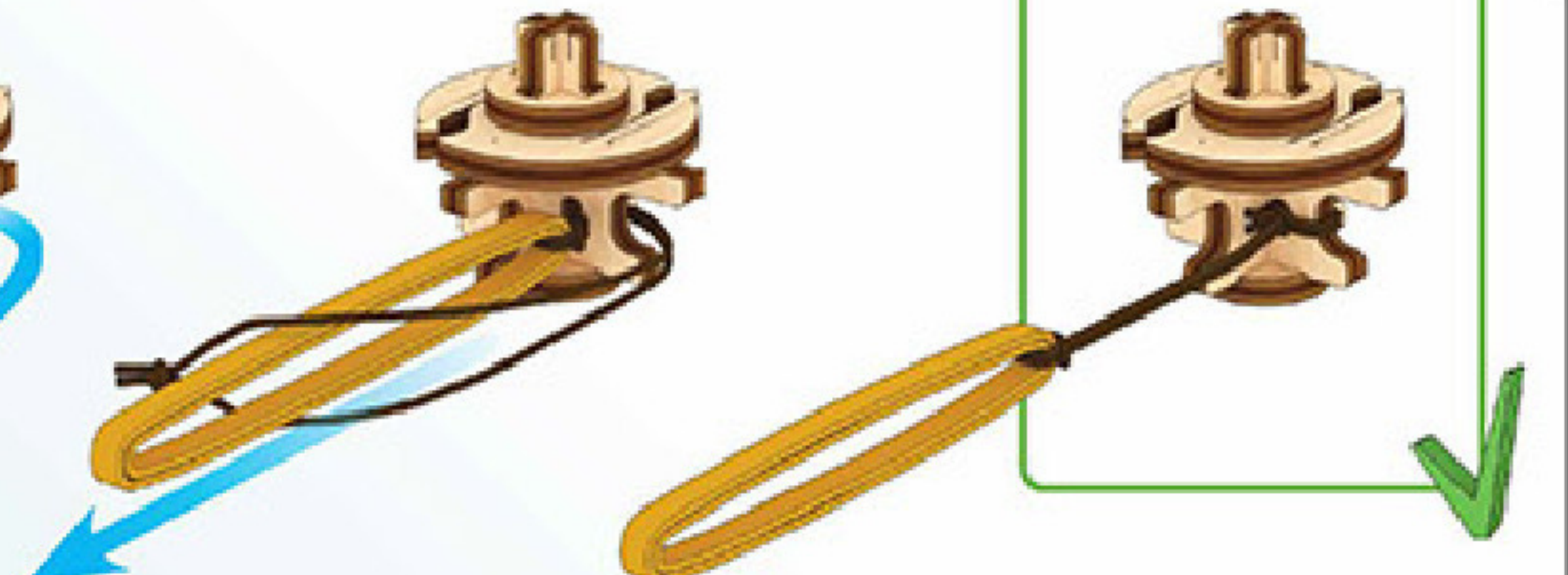



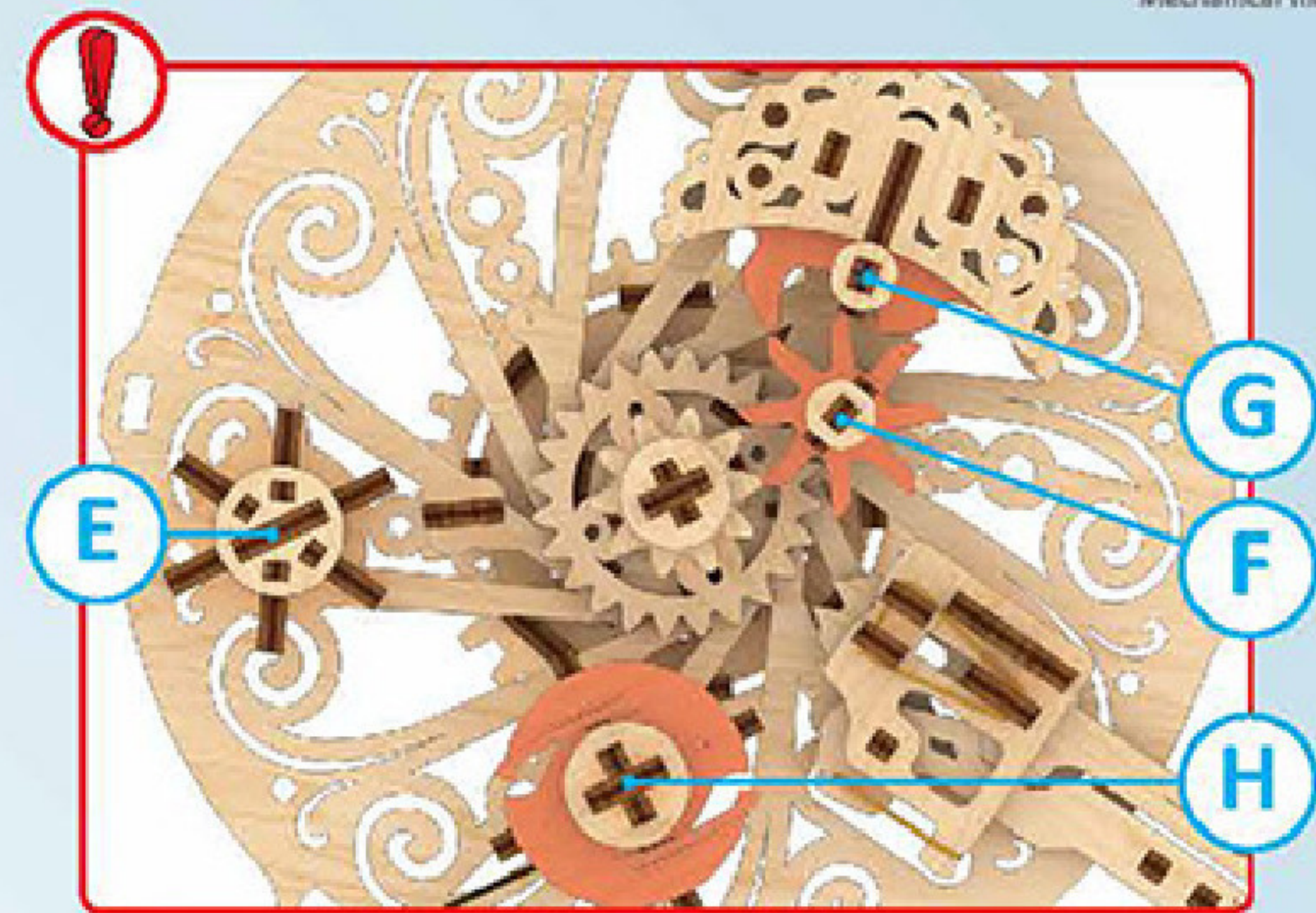
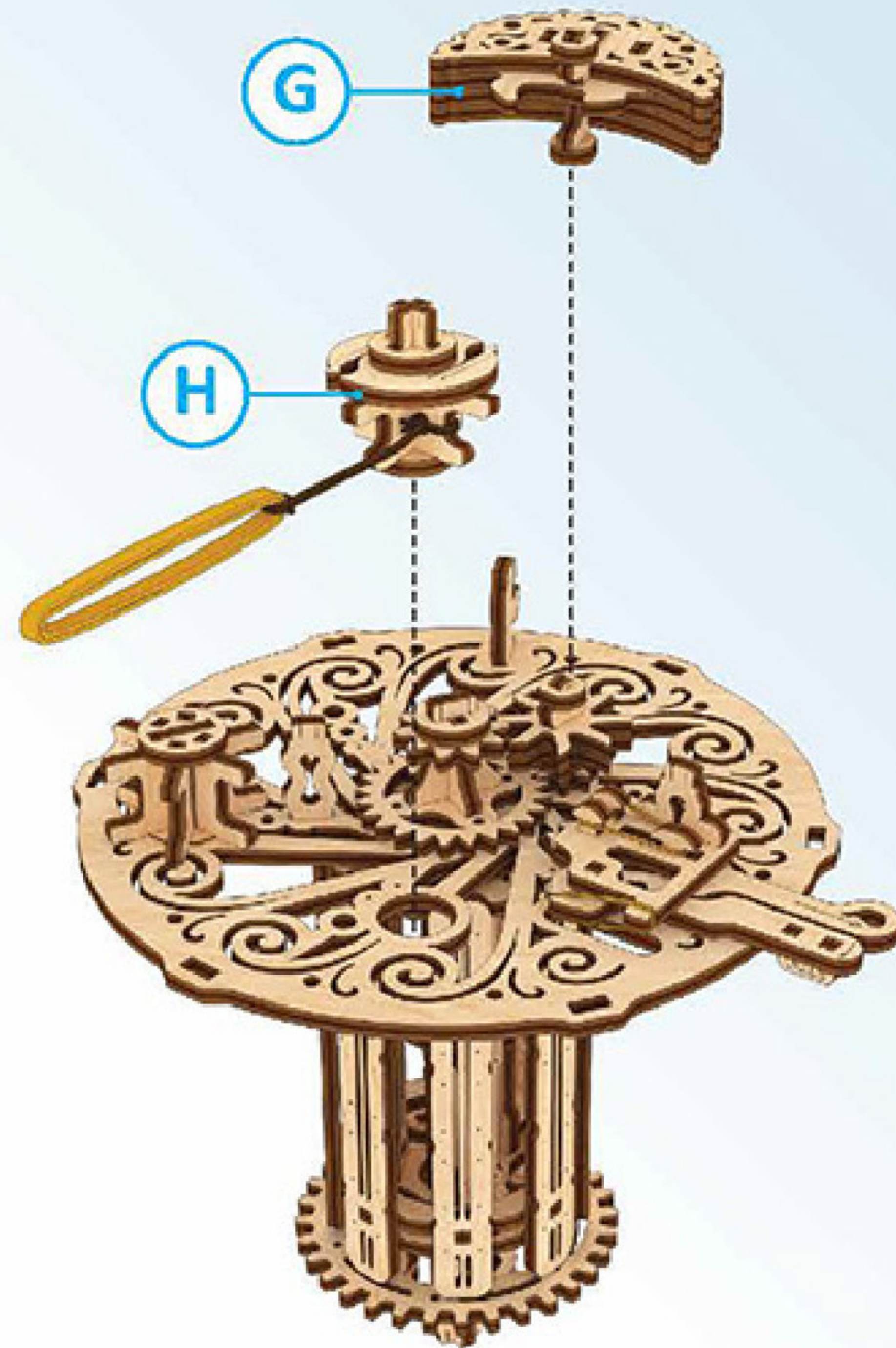
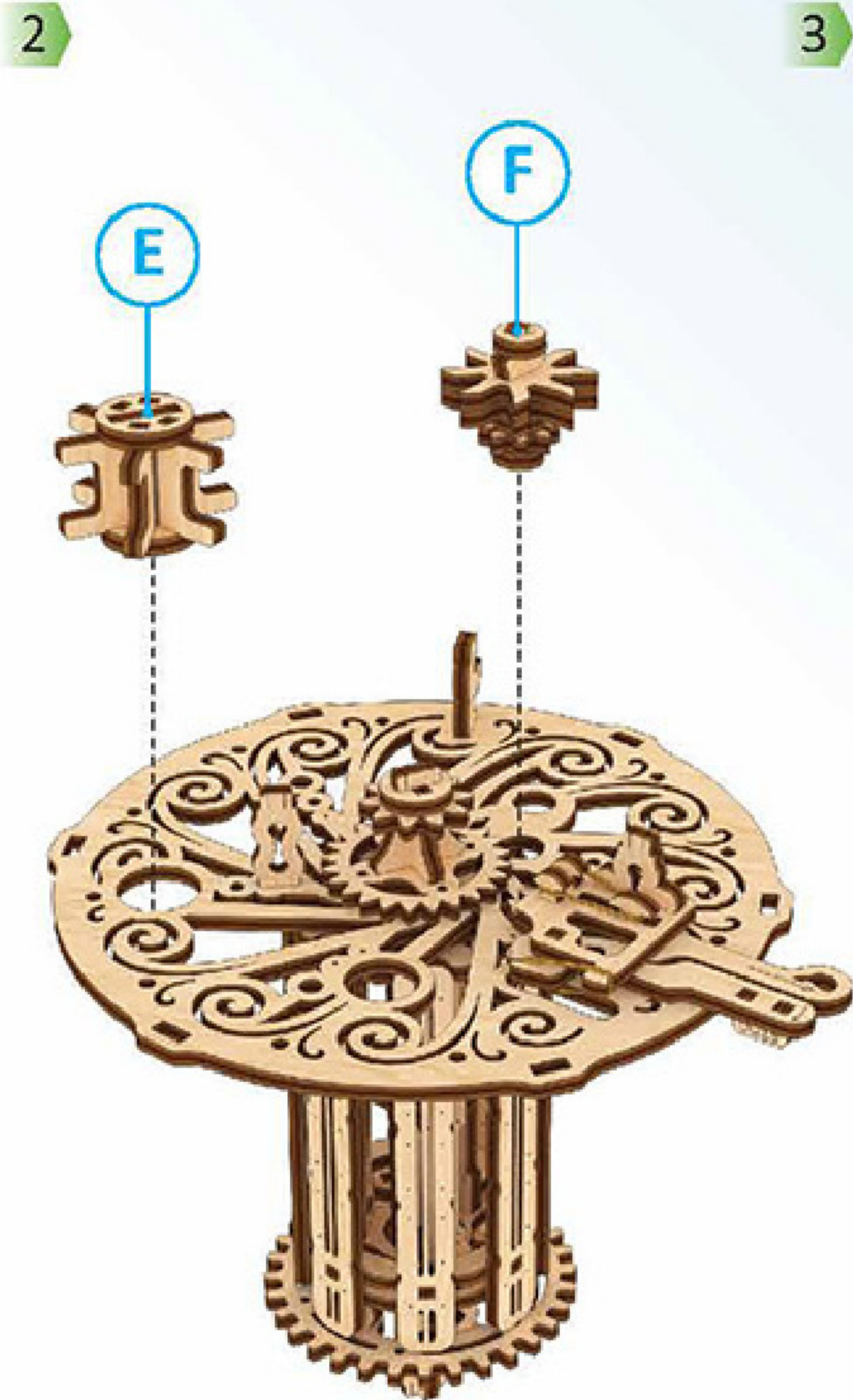



4

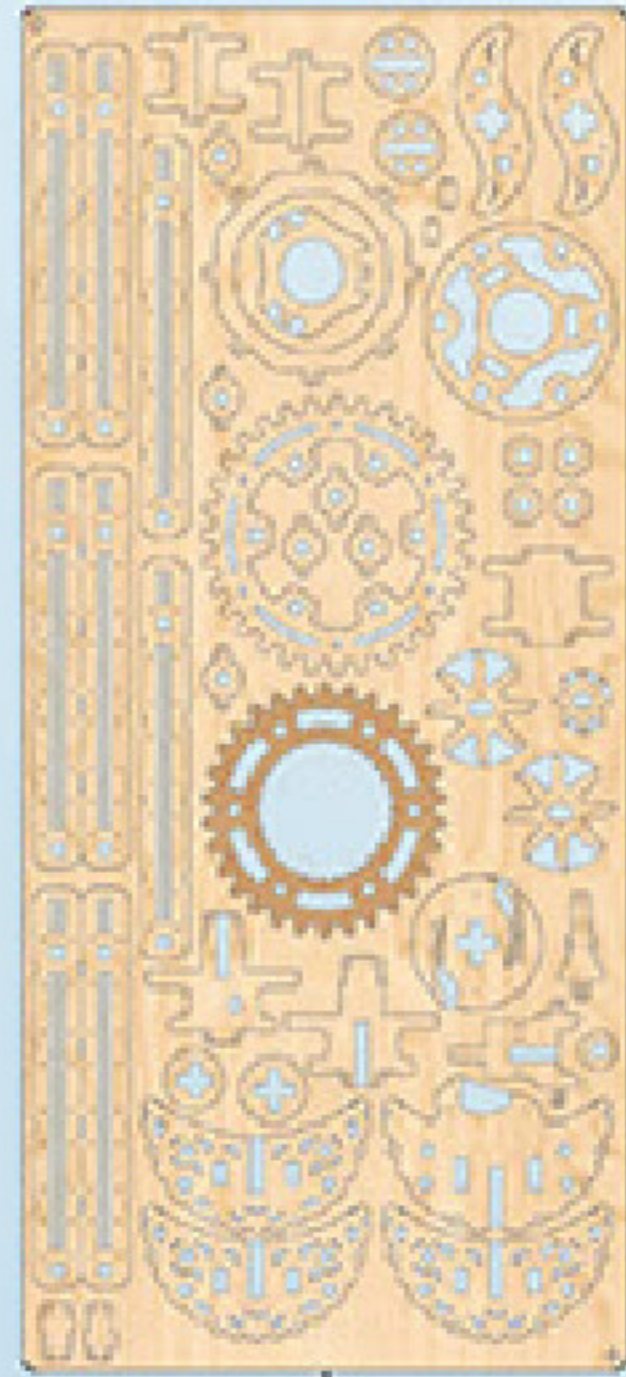

2

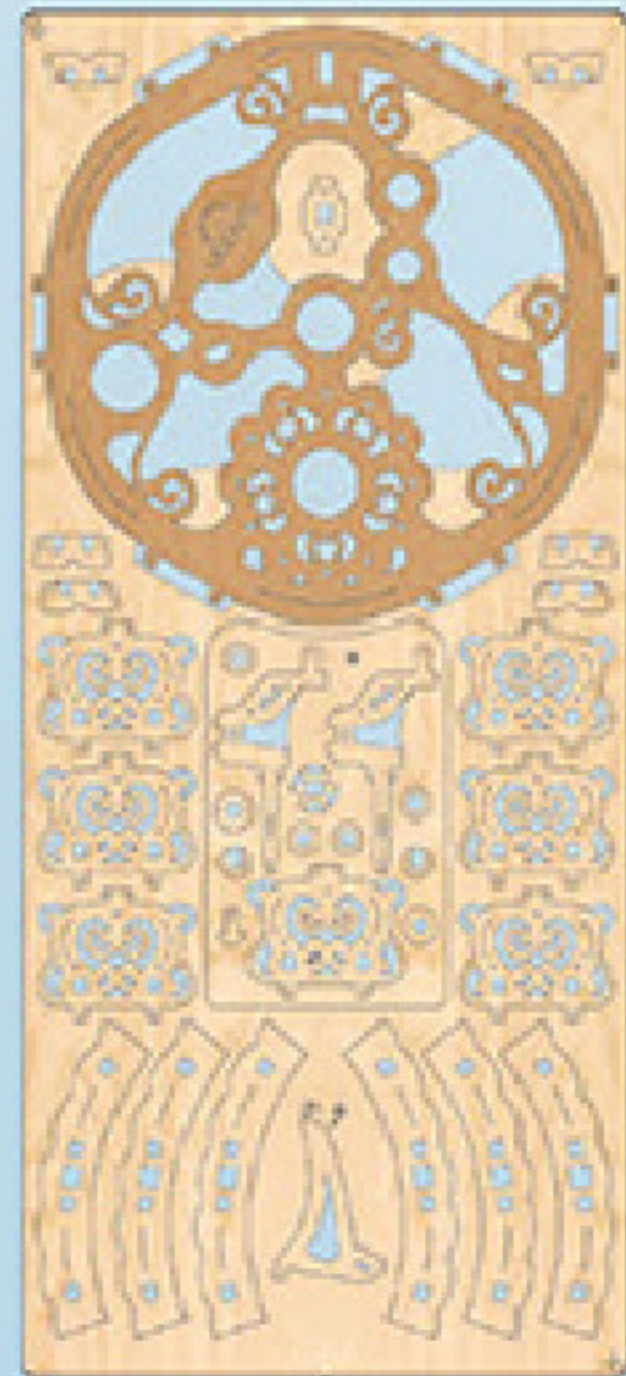

3

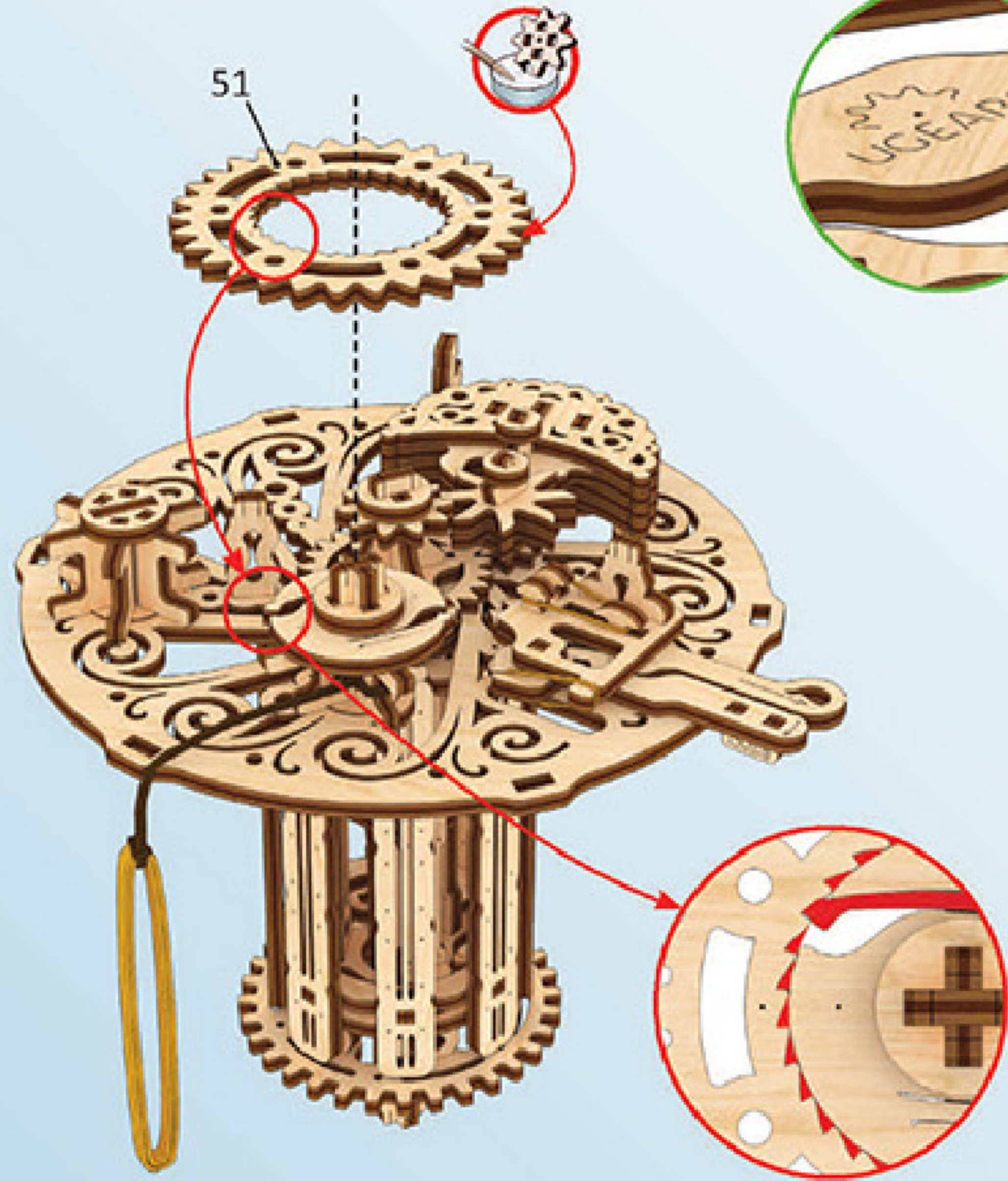

5

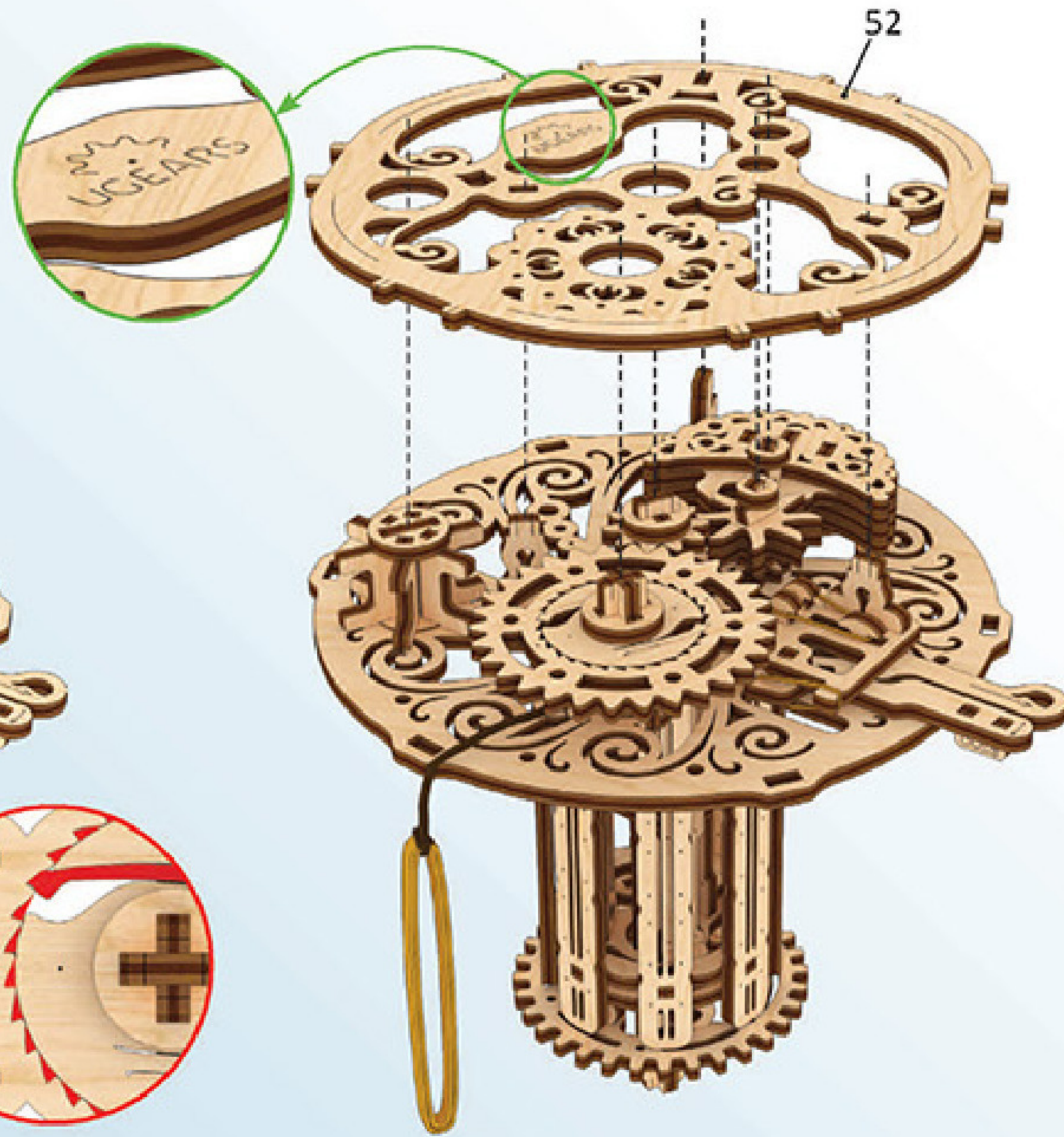

6

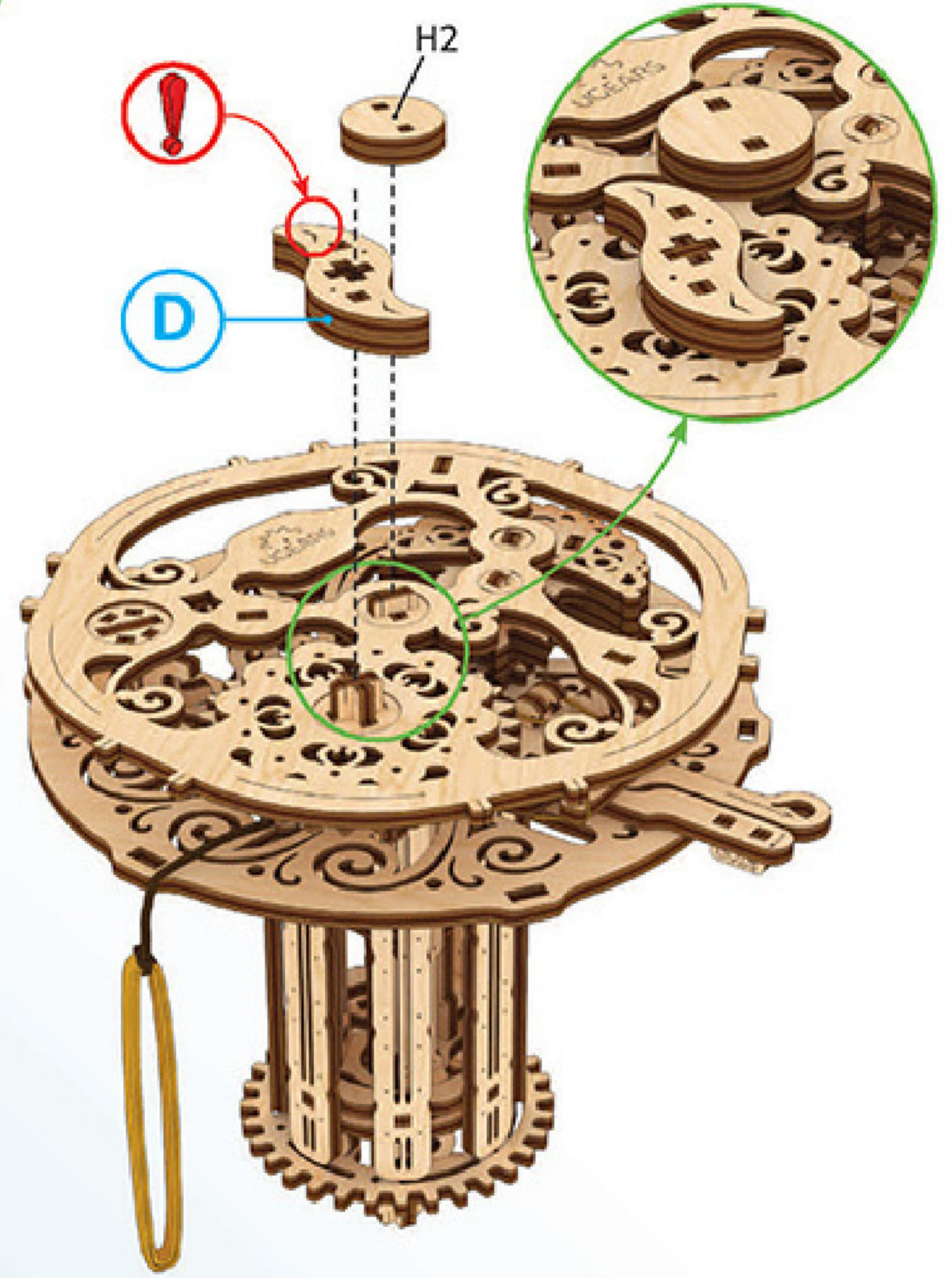



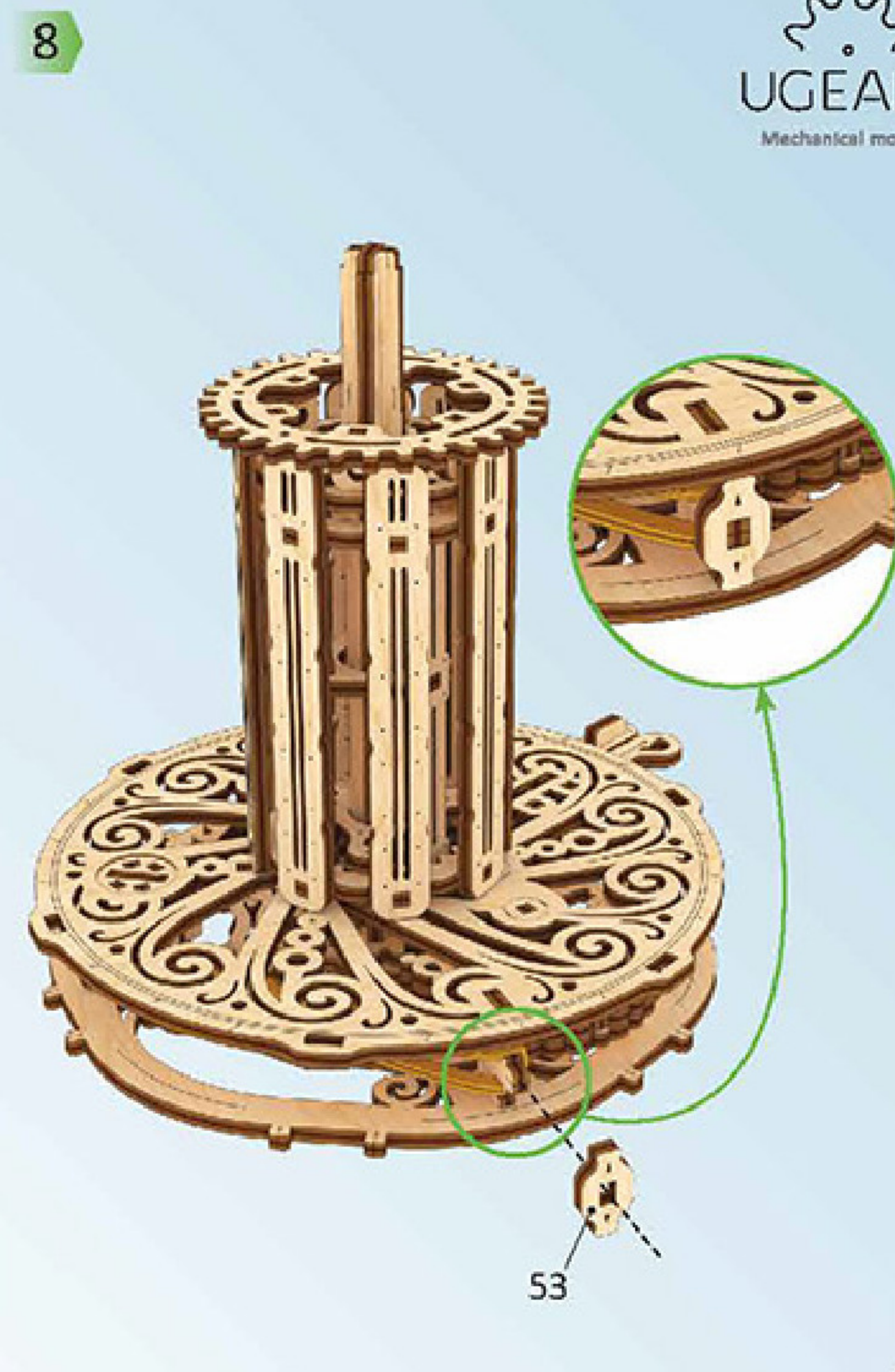
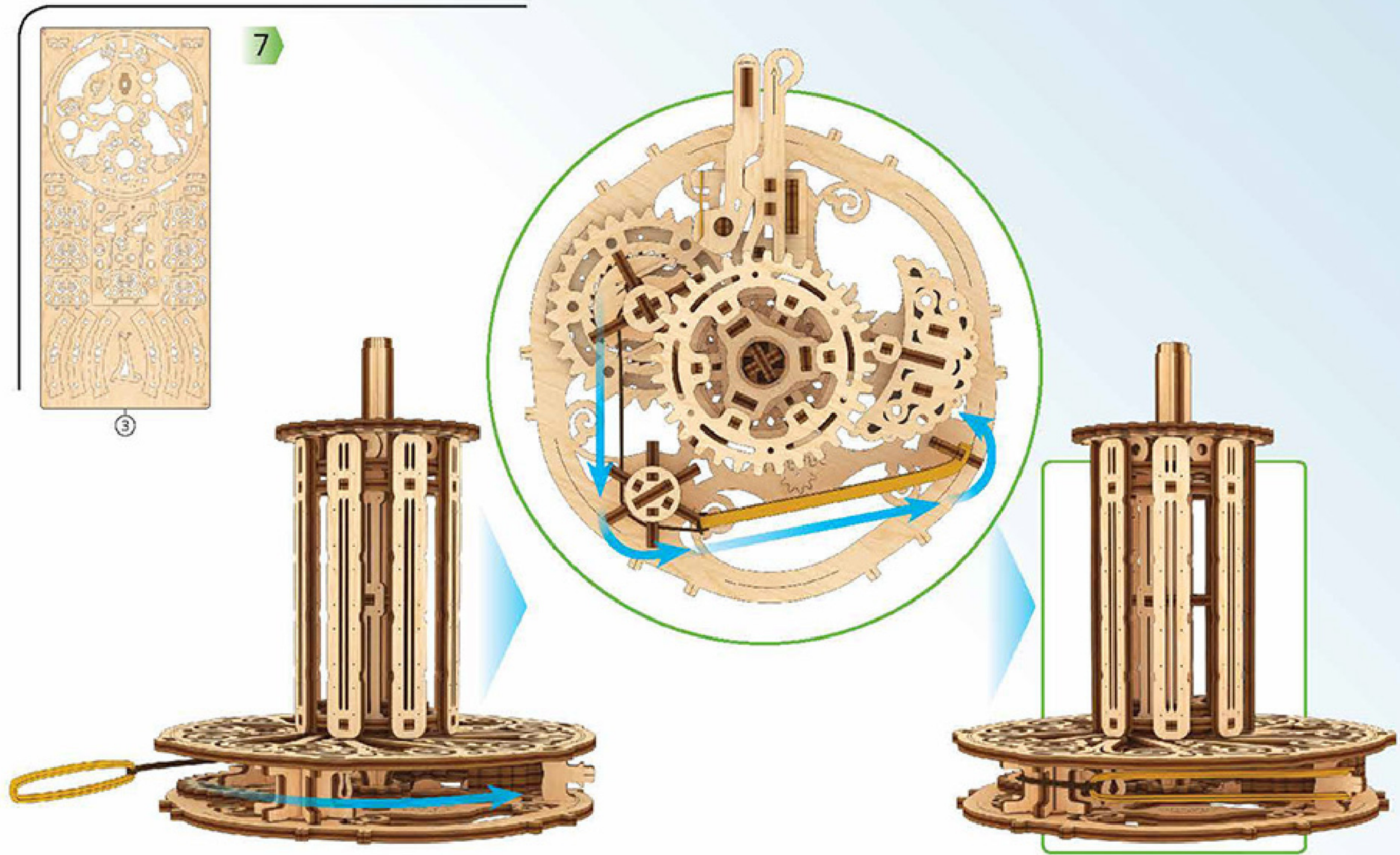



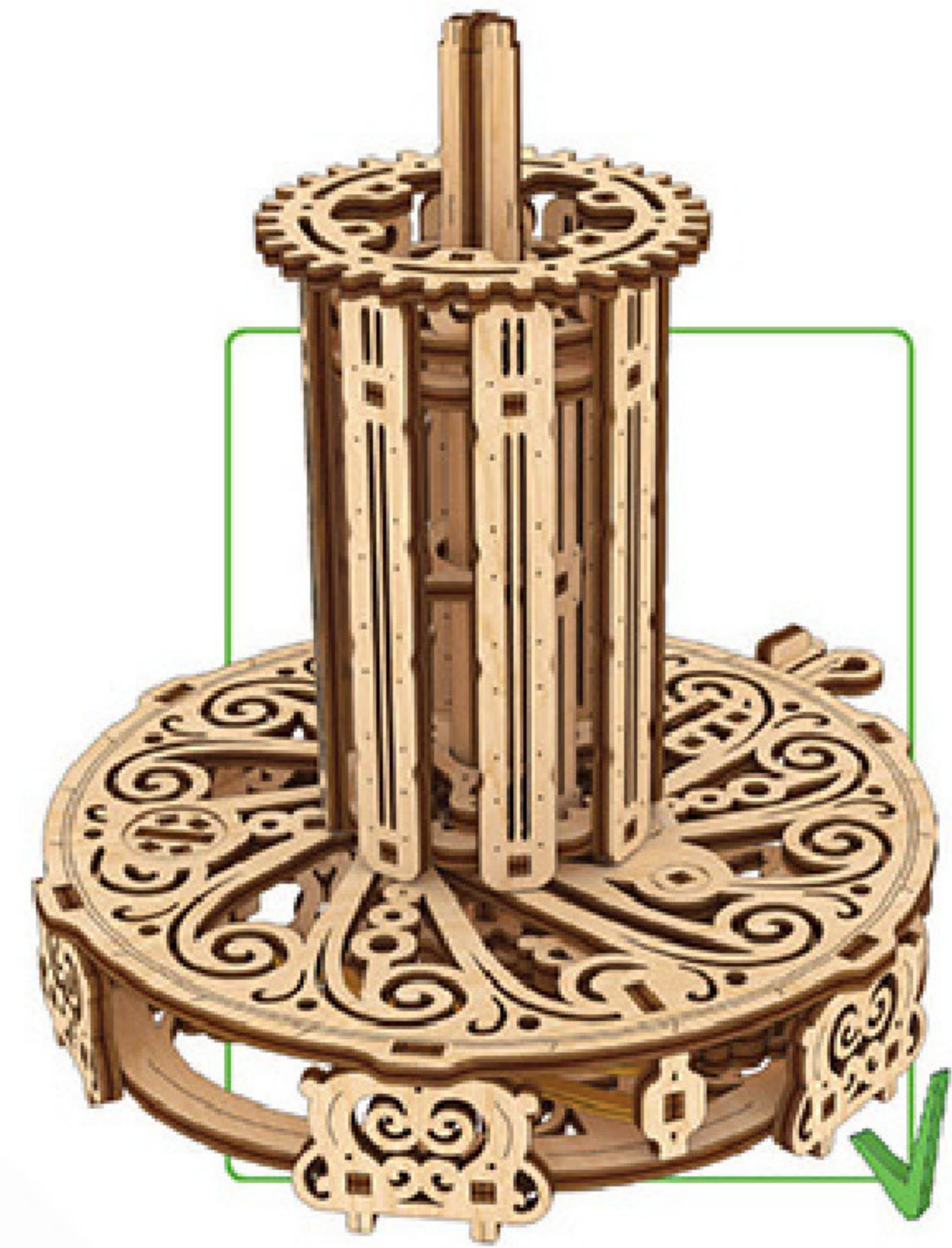
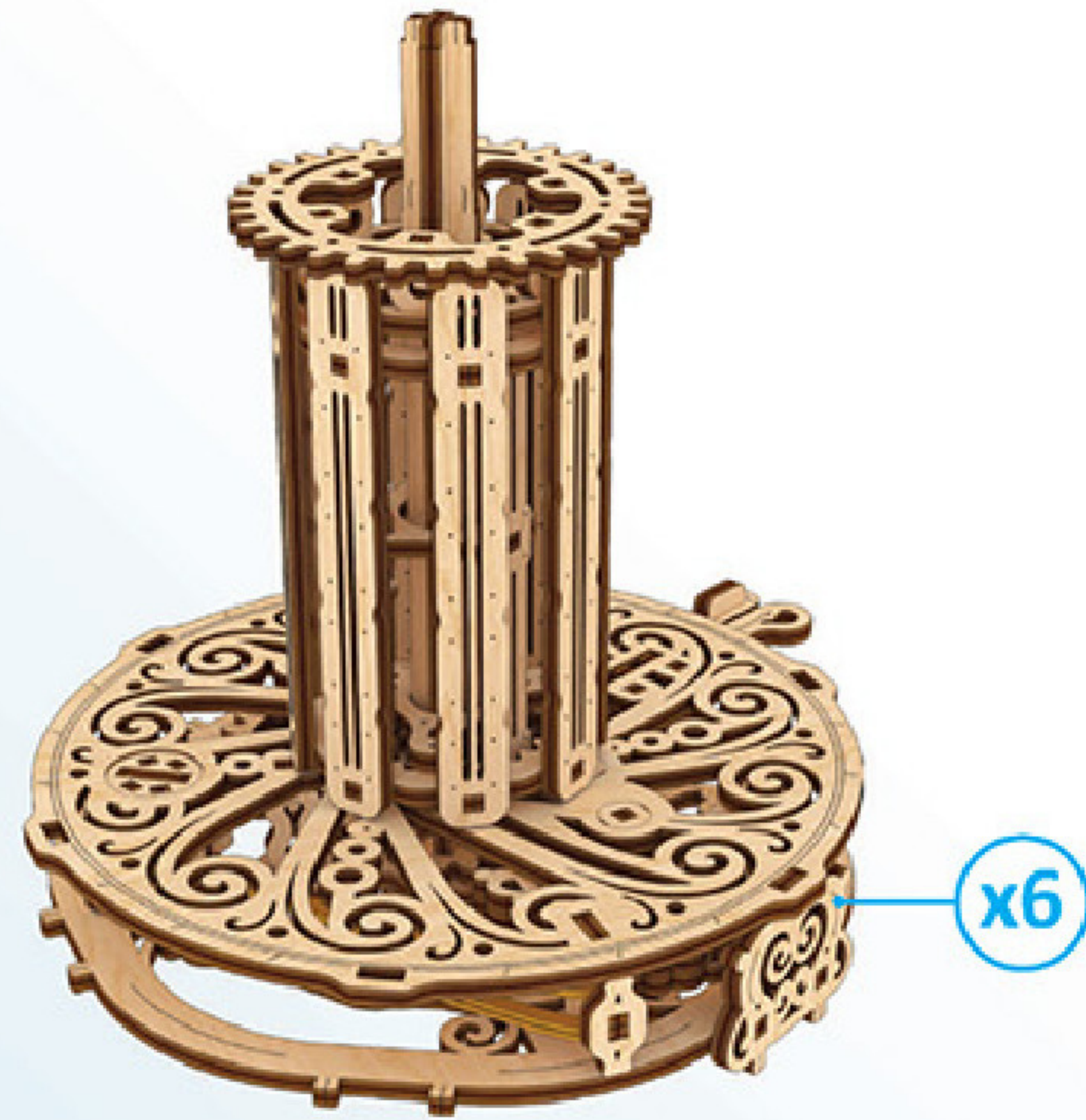
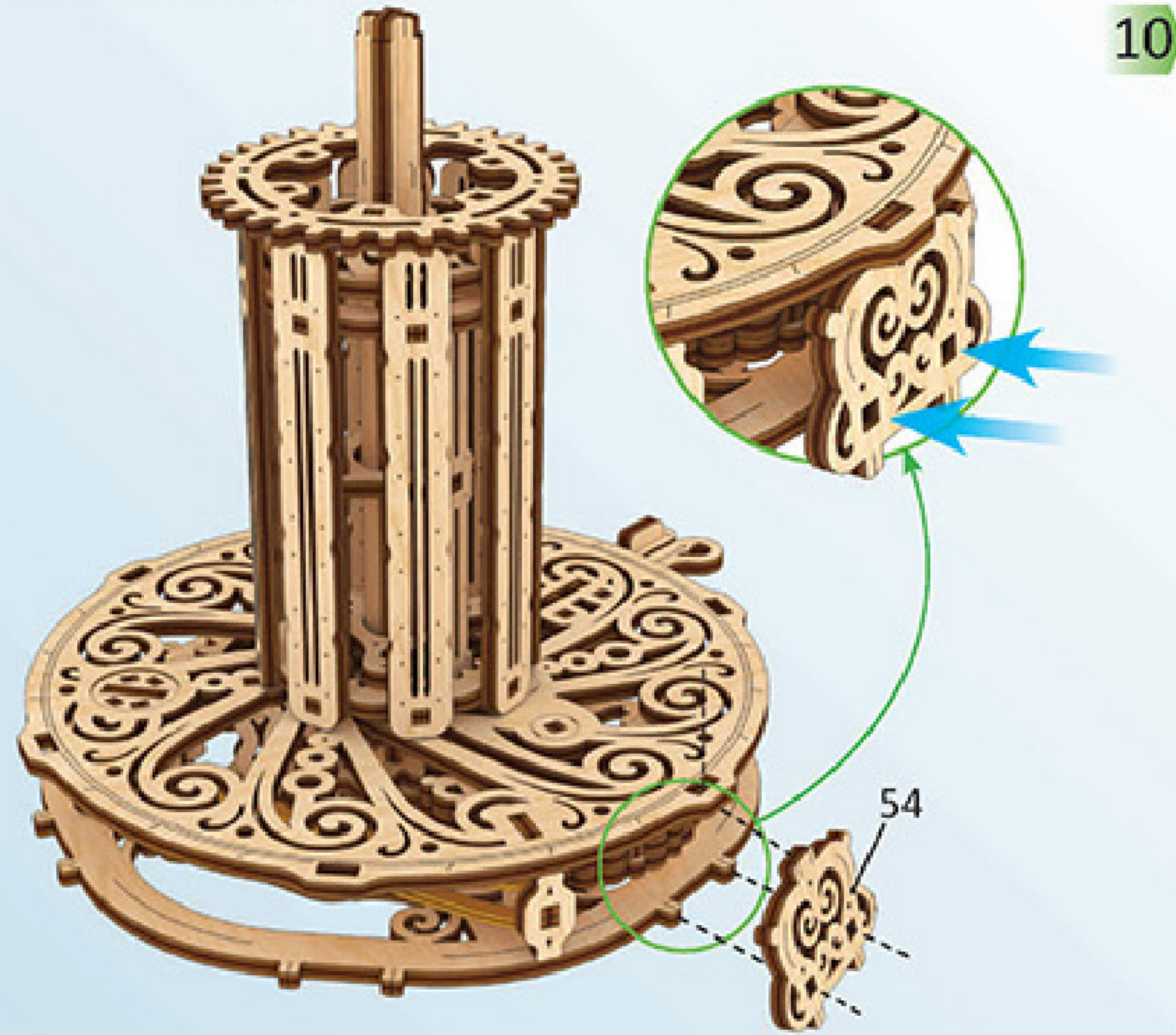
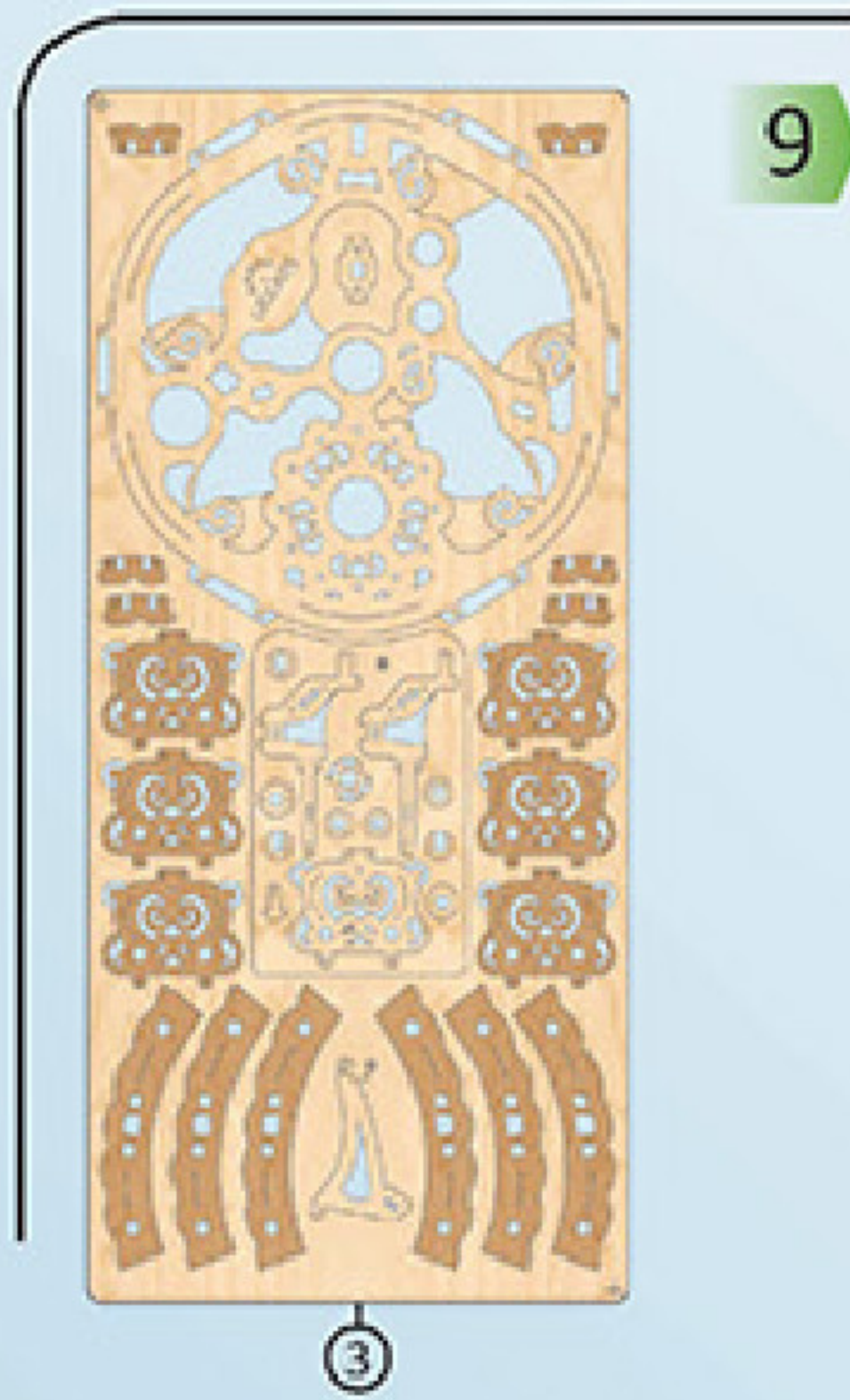

1

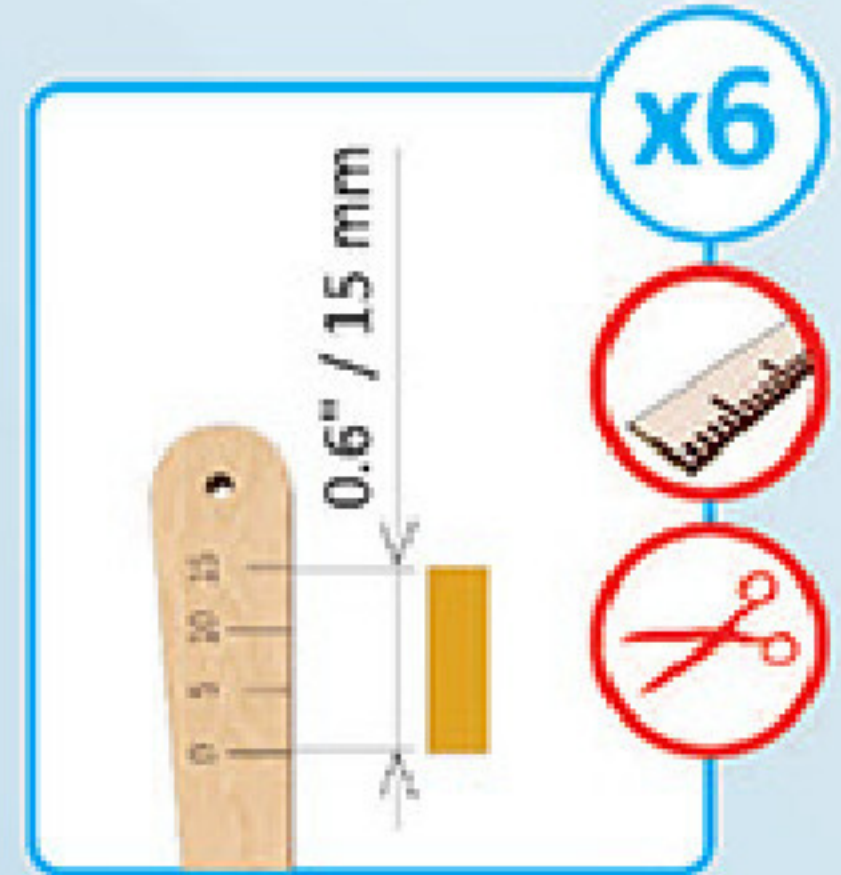
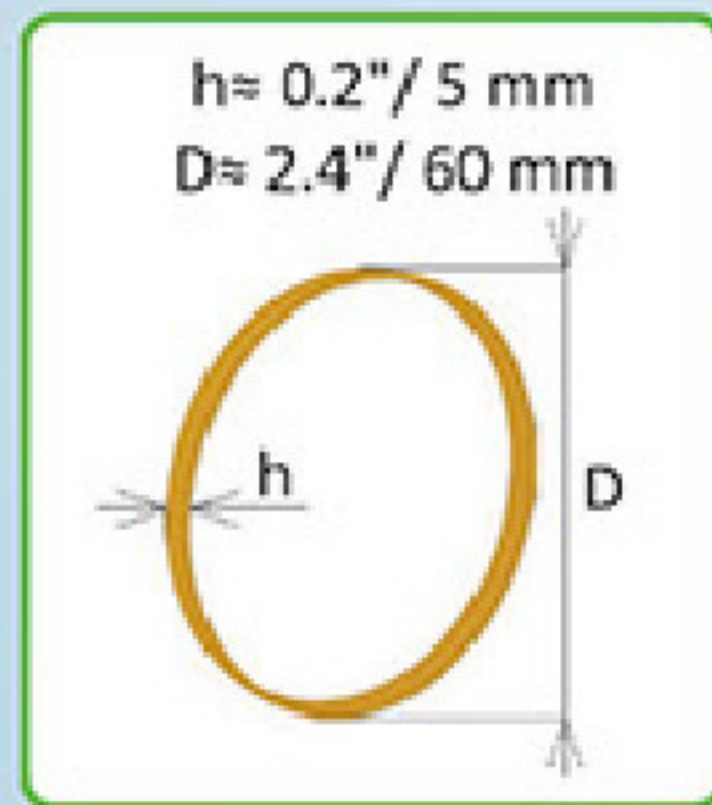

2



3

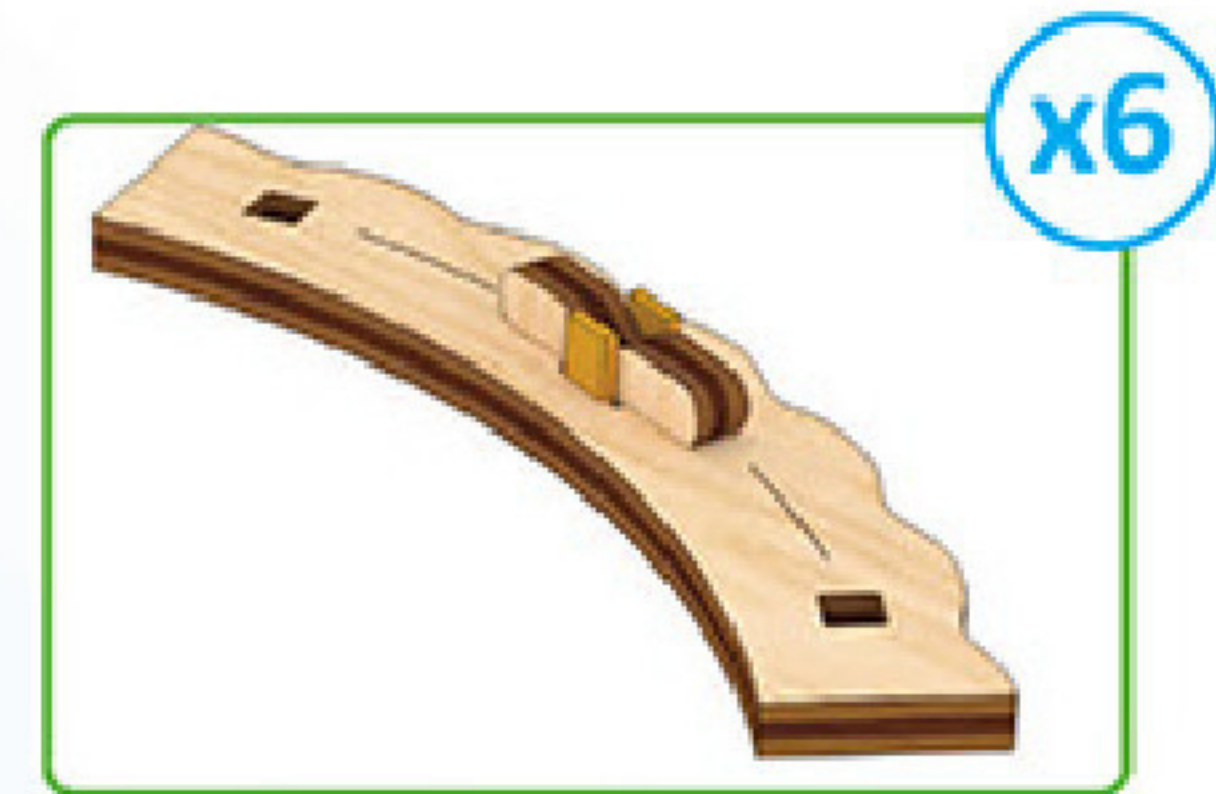
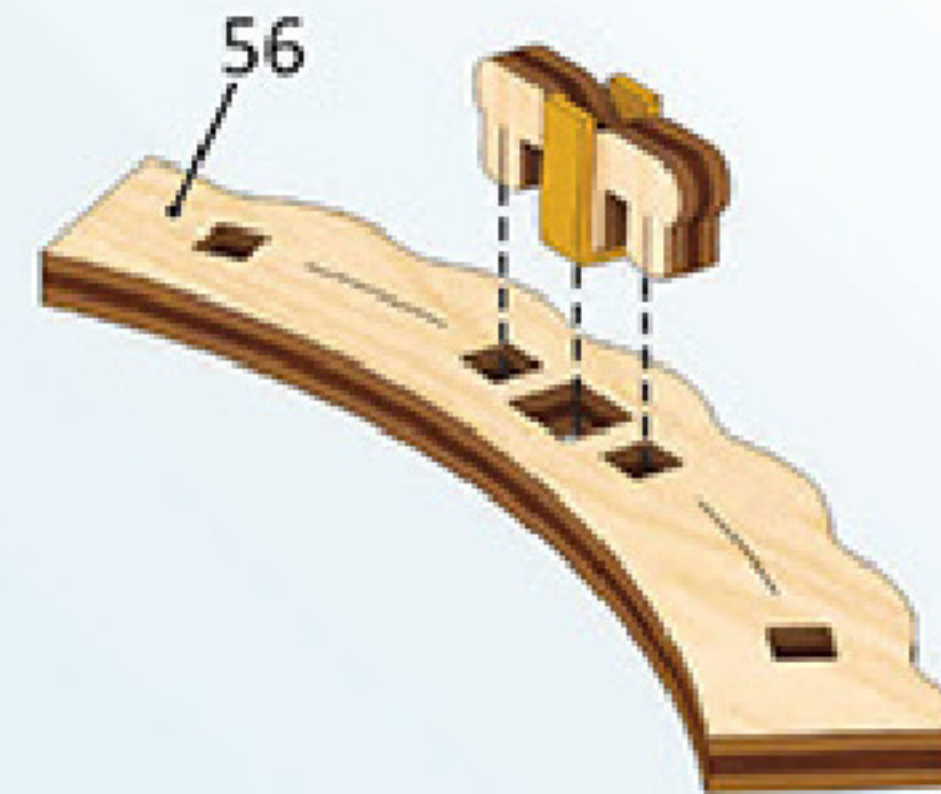



4

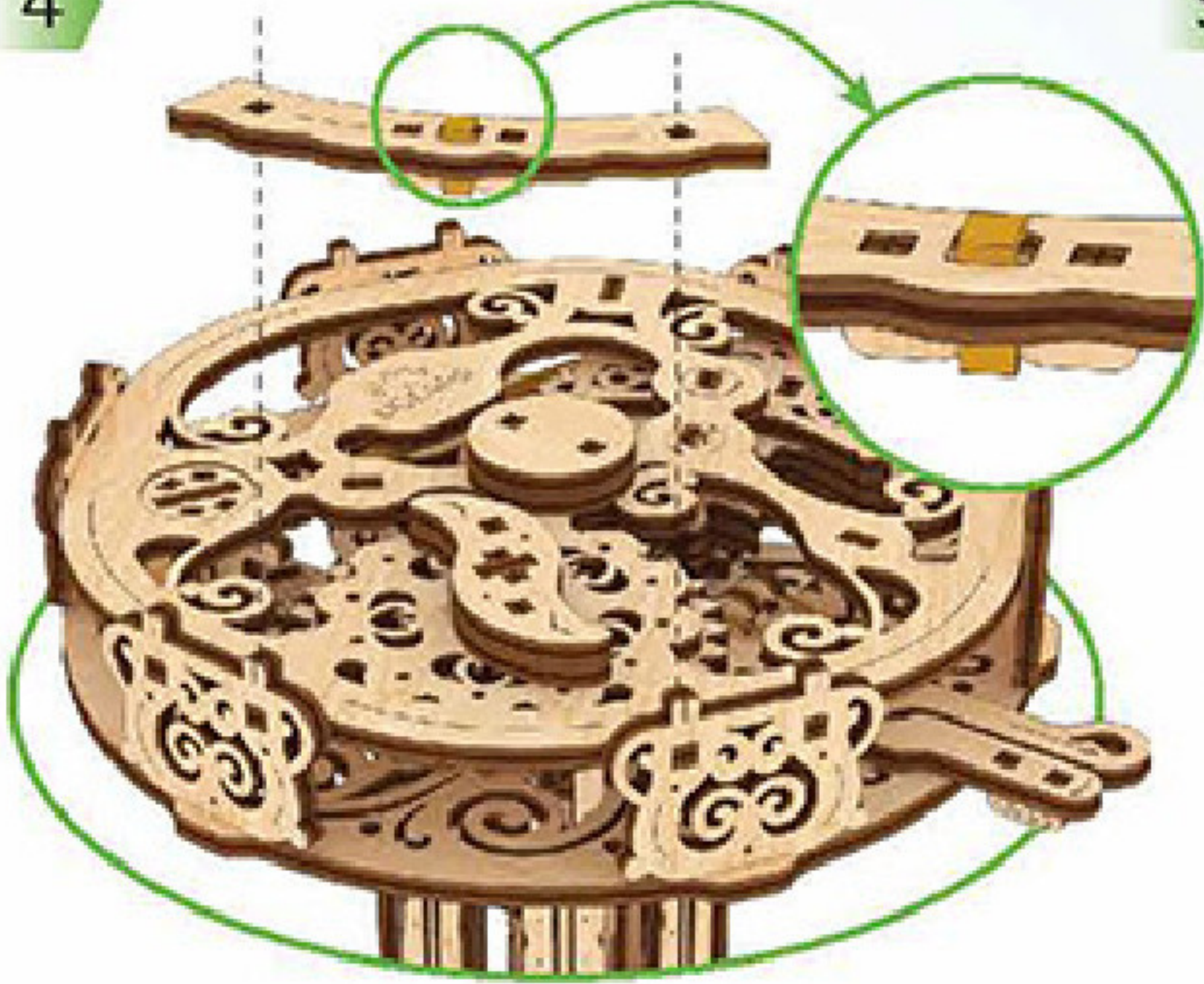

5



6

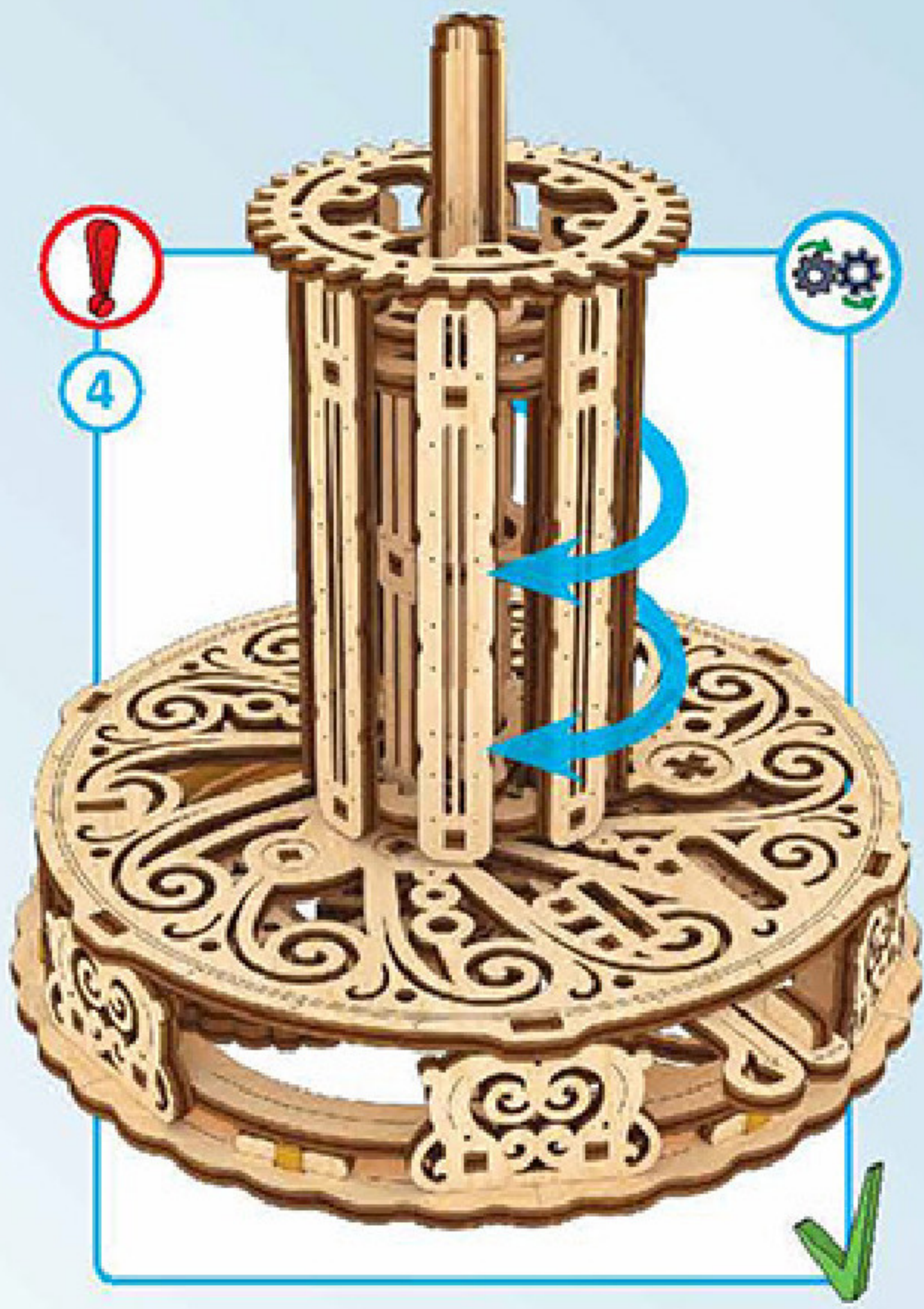
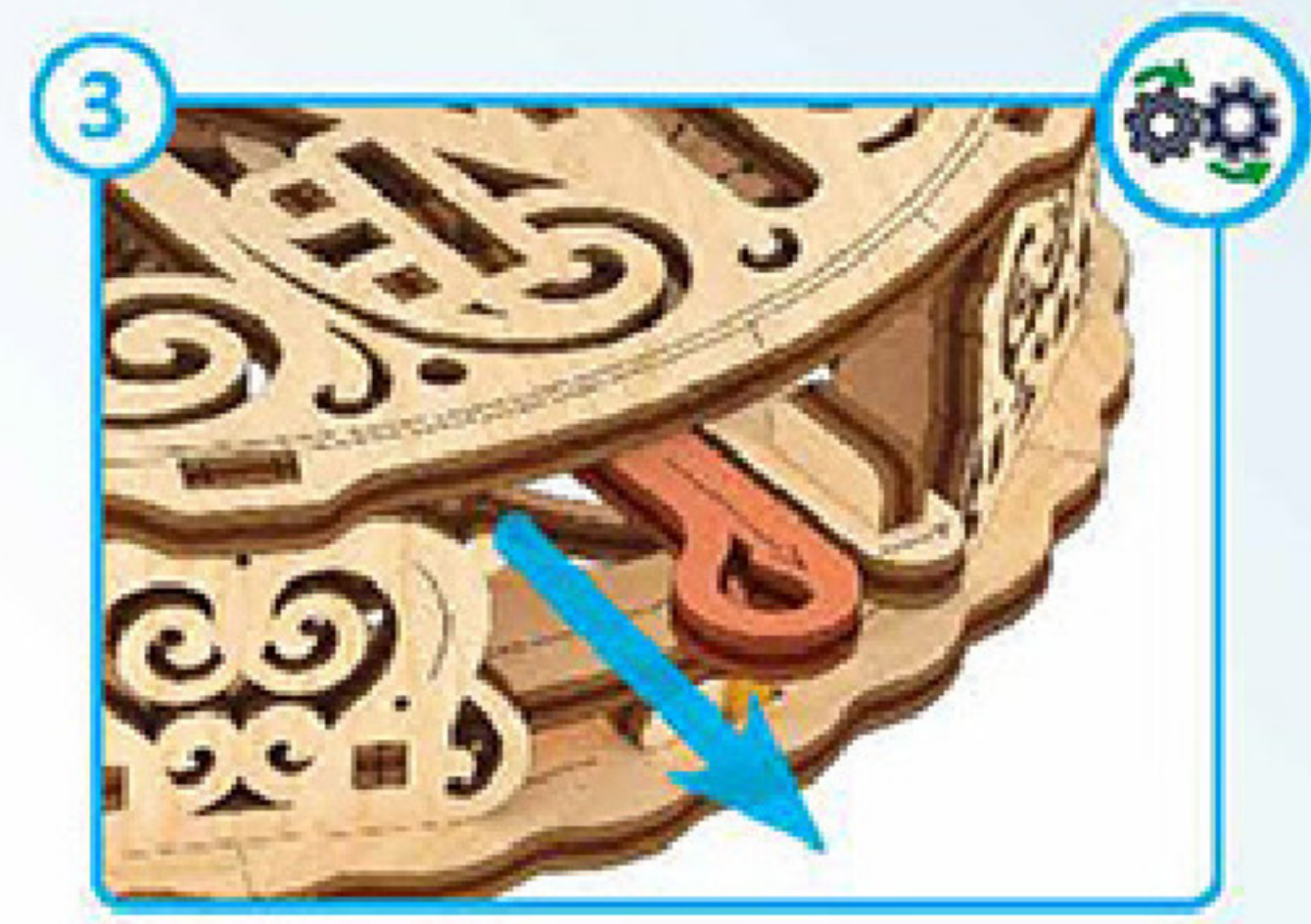
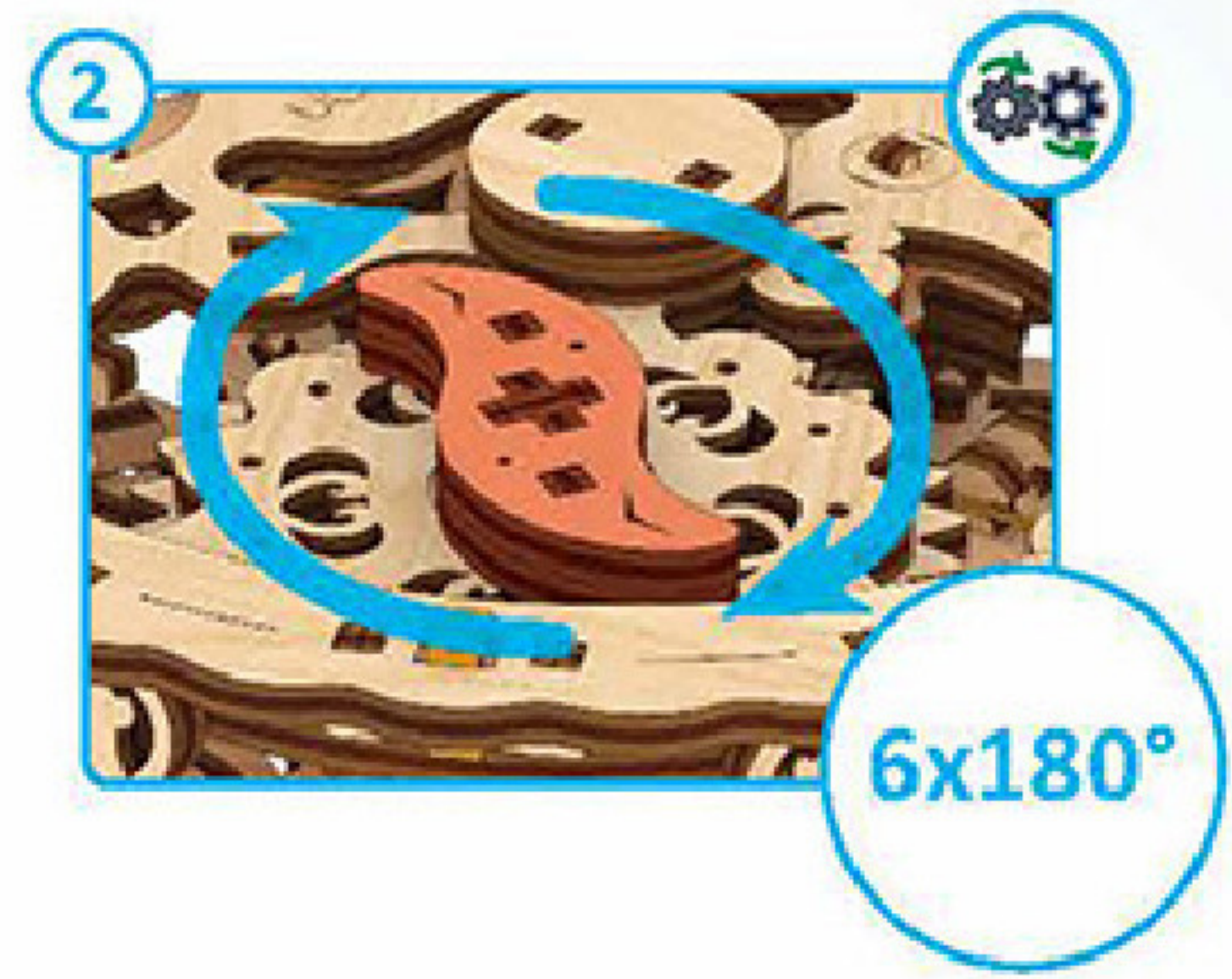



1

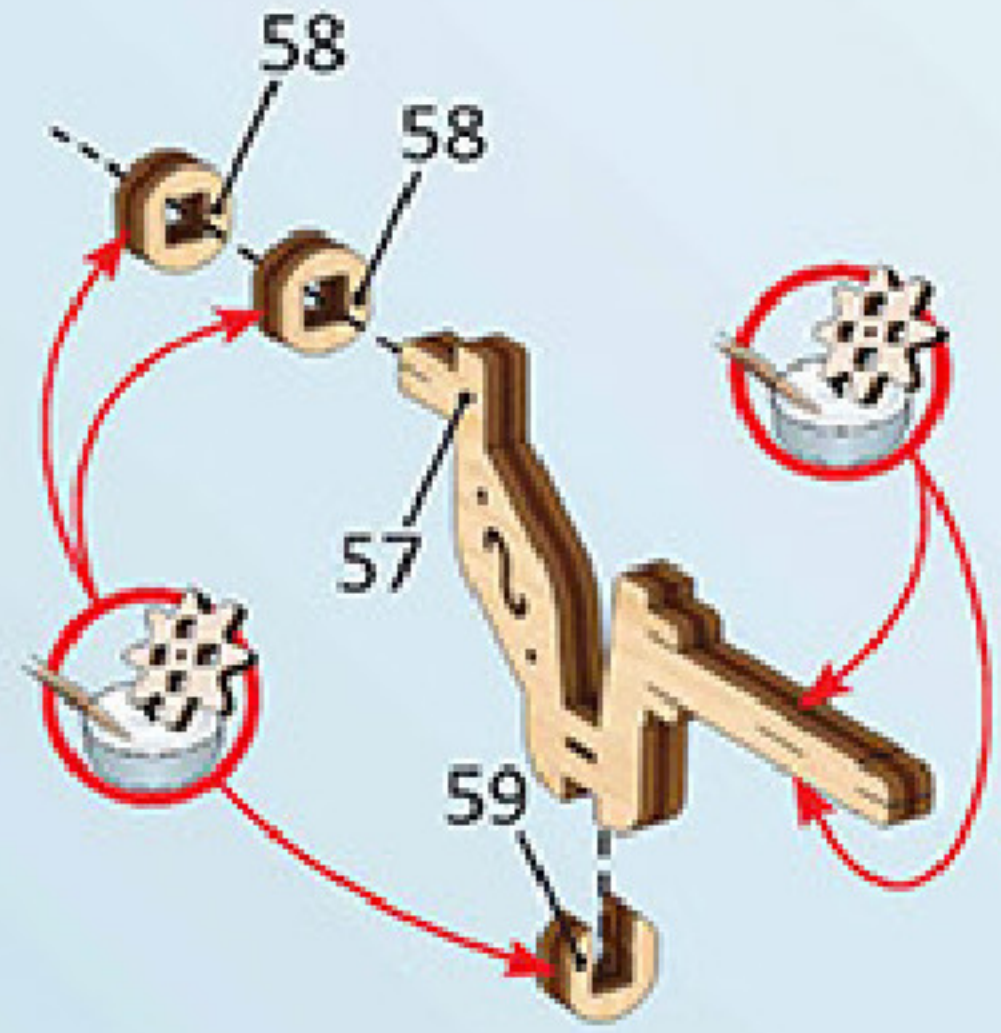

2

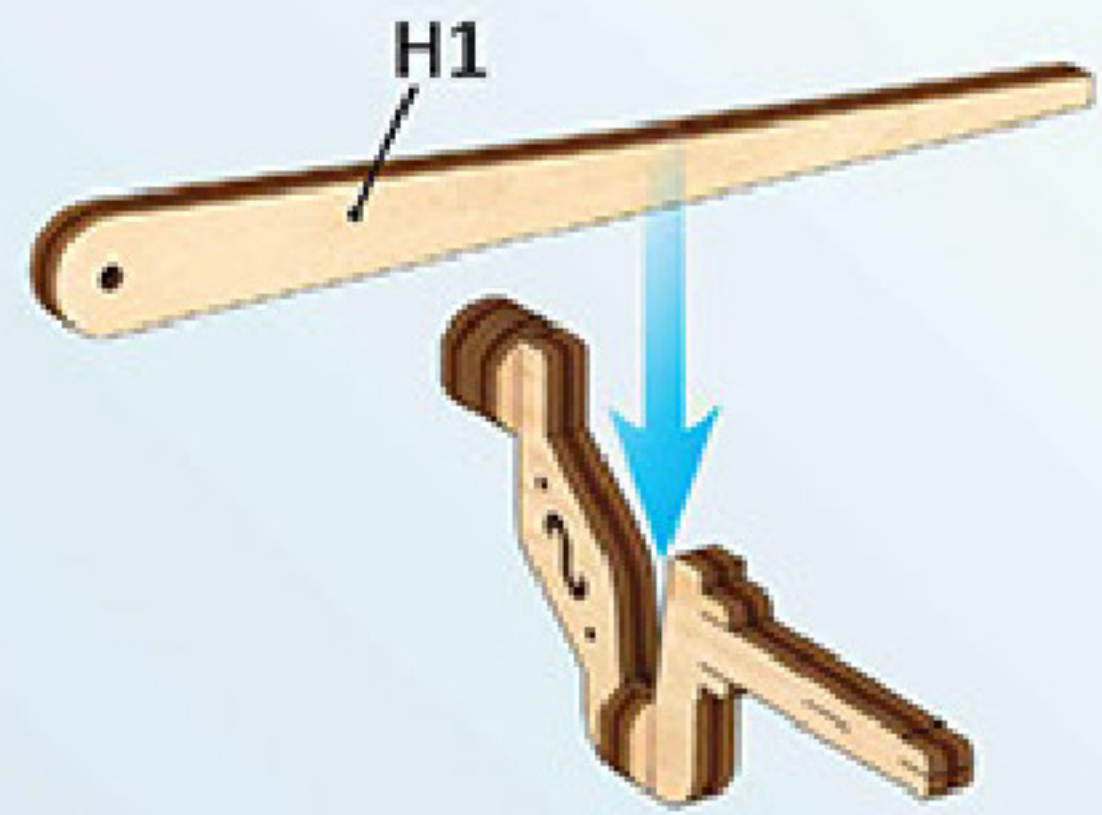

3

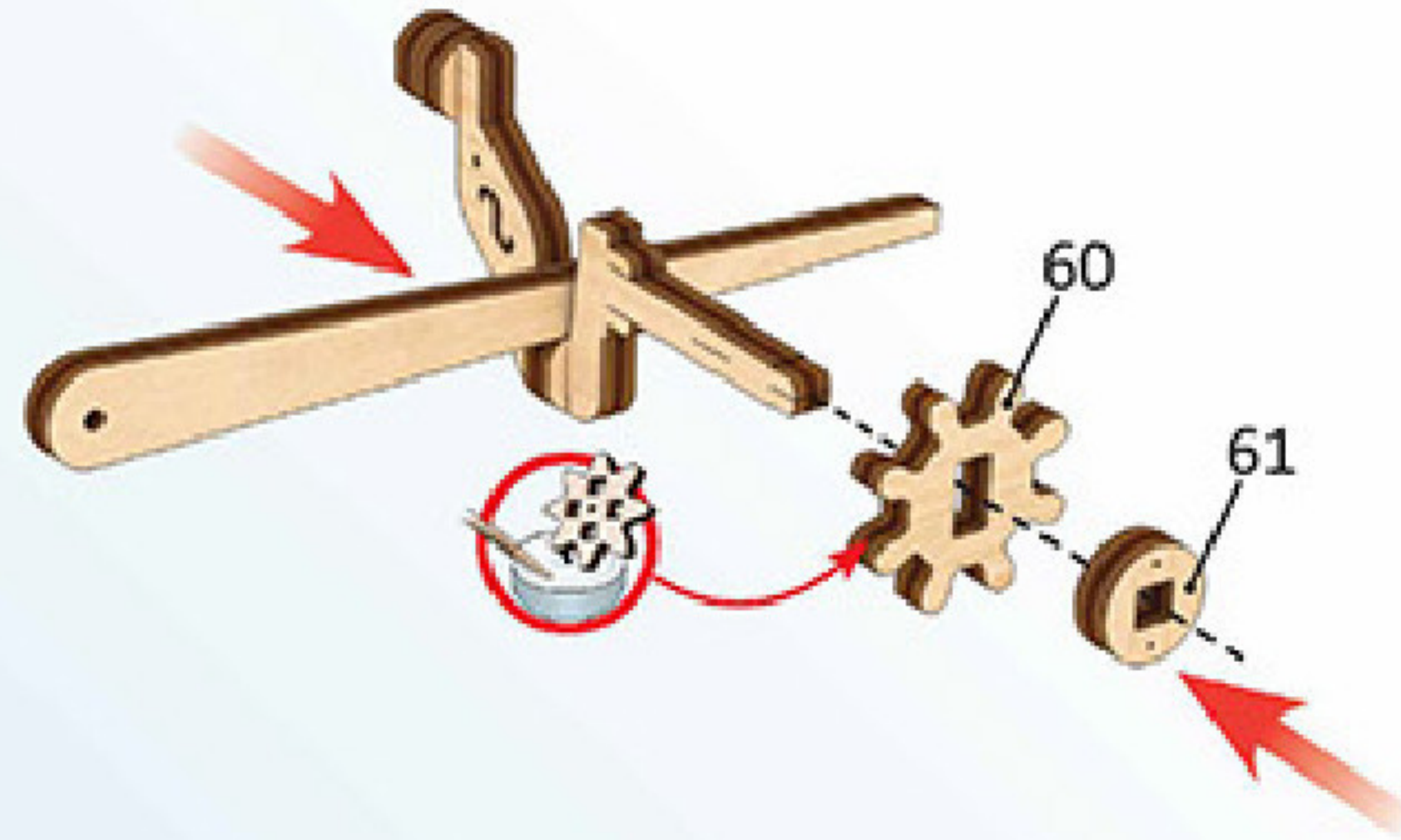

4

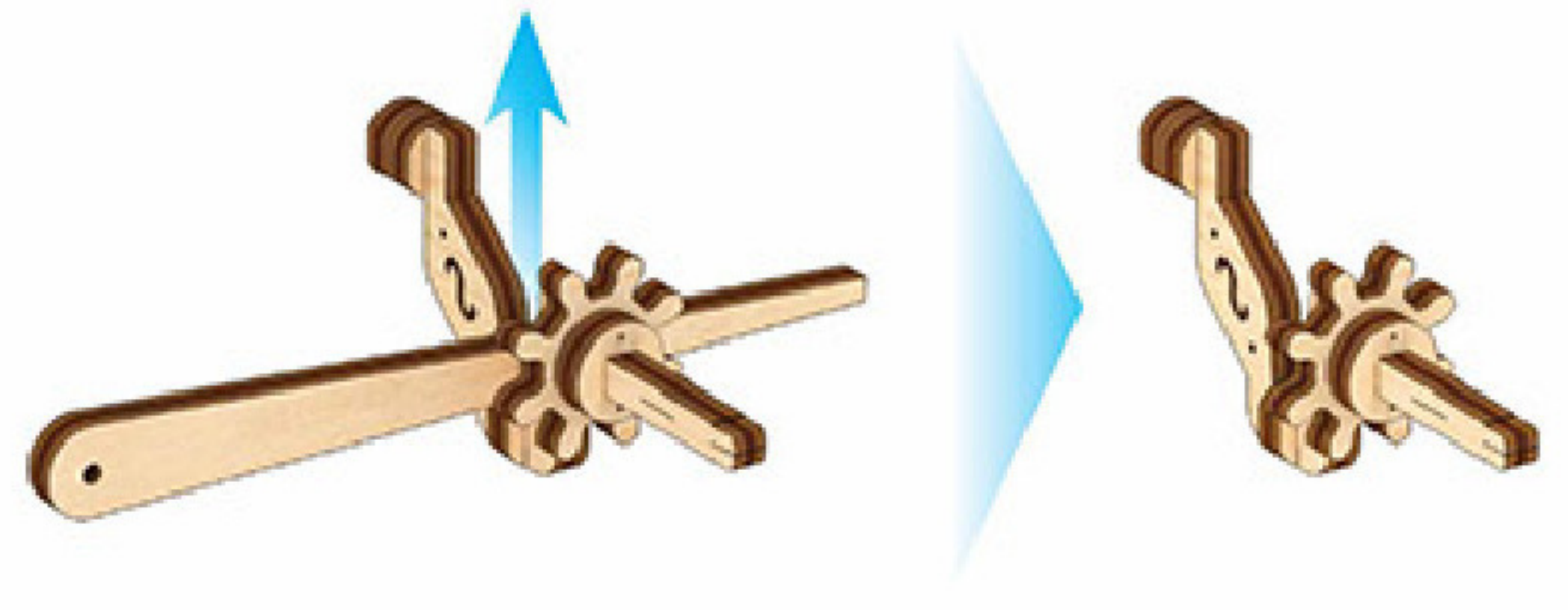

5

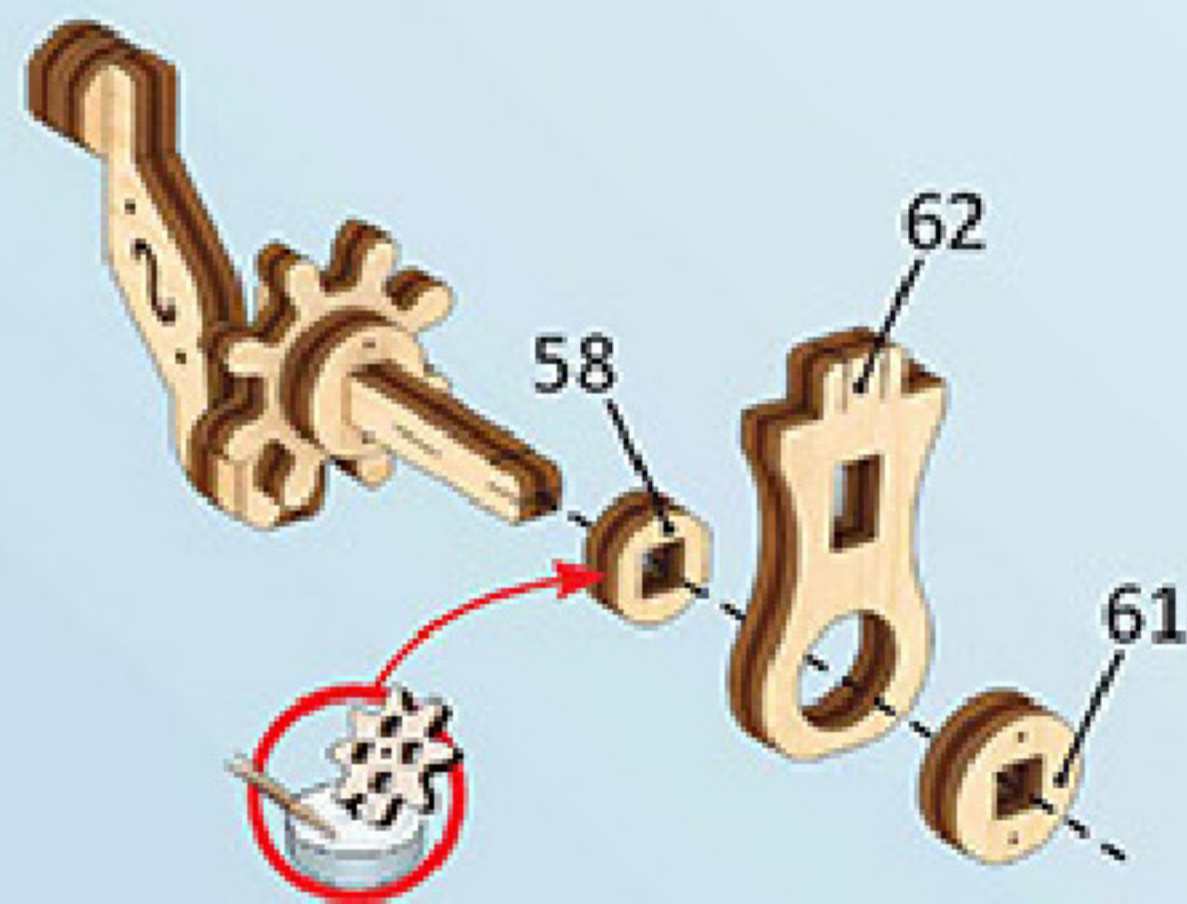

6

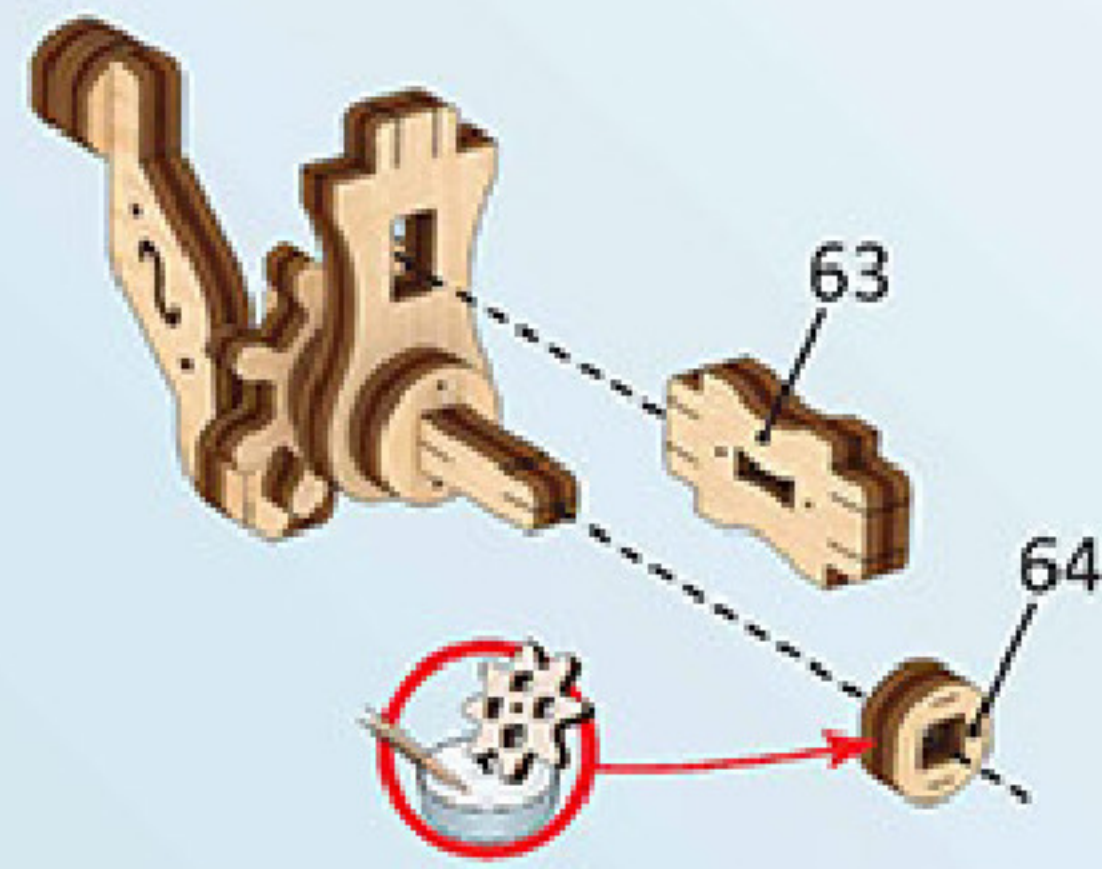

7

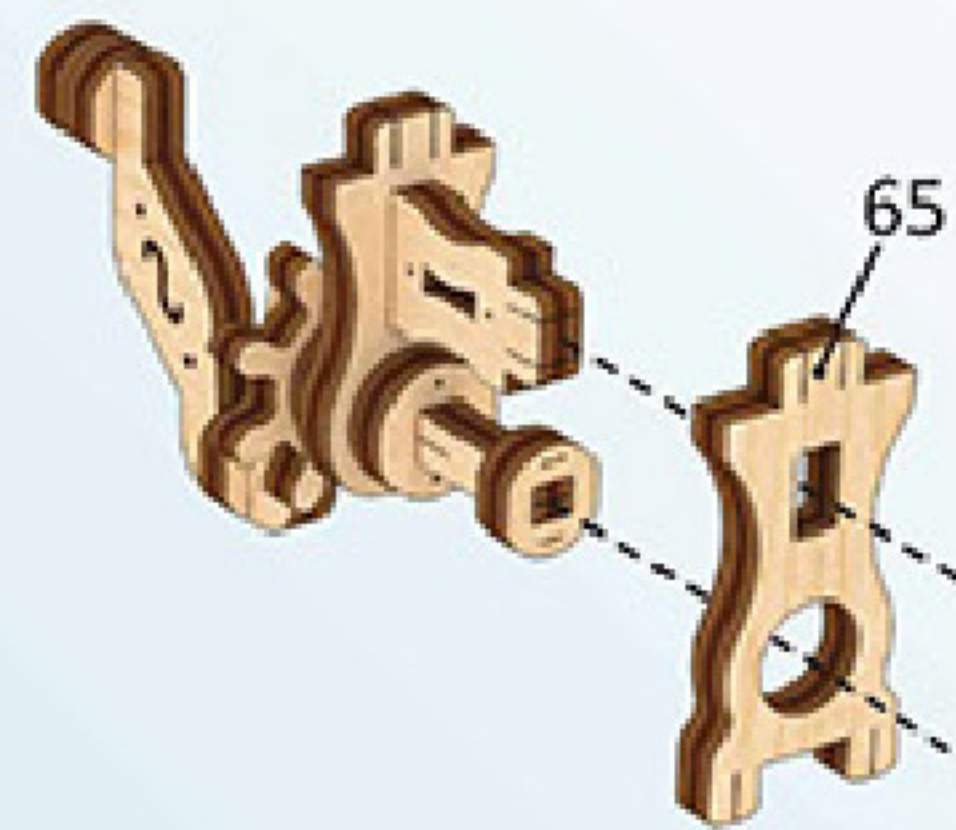





④

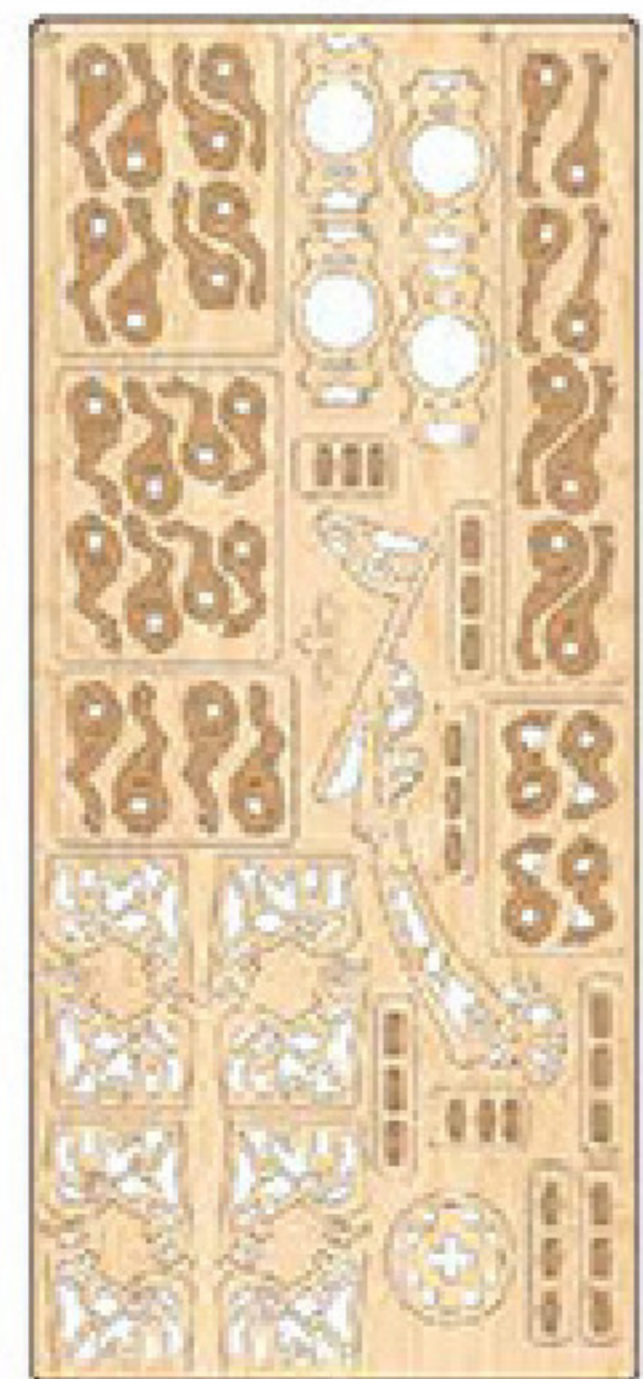

⑤

1

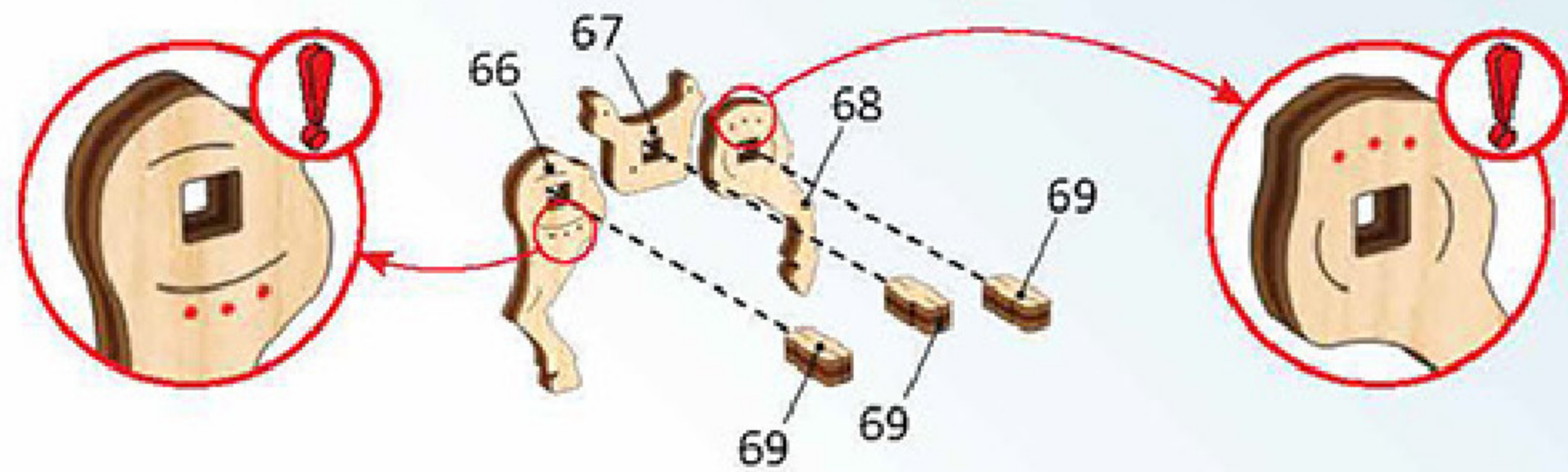

2

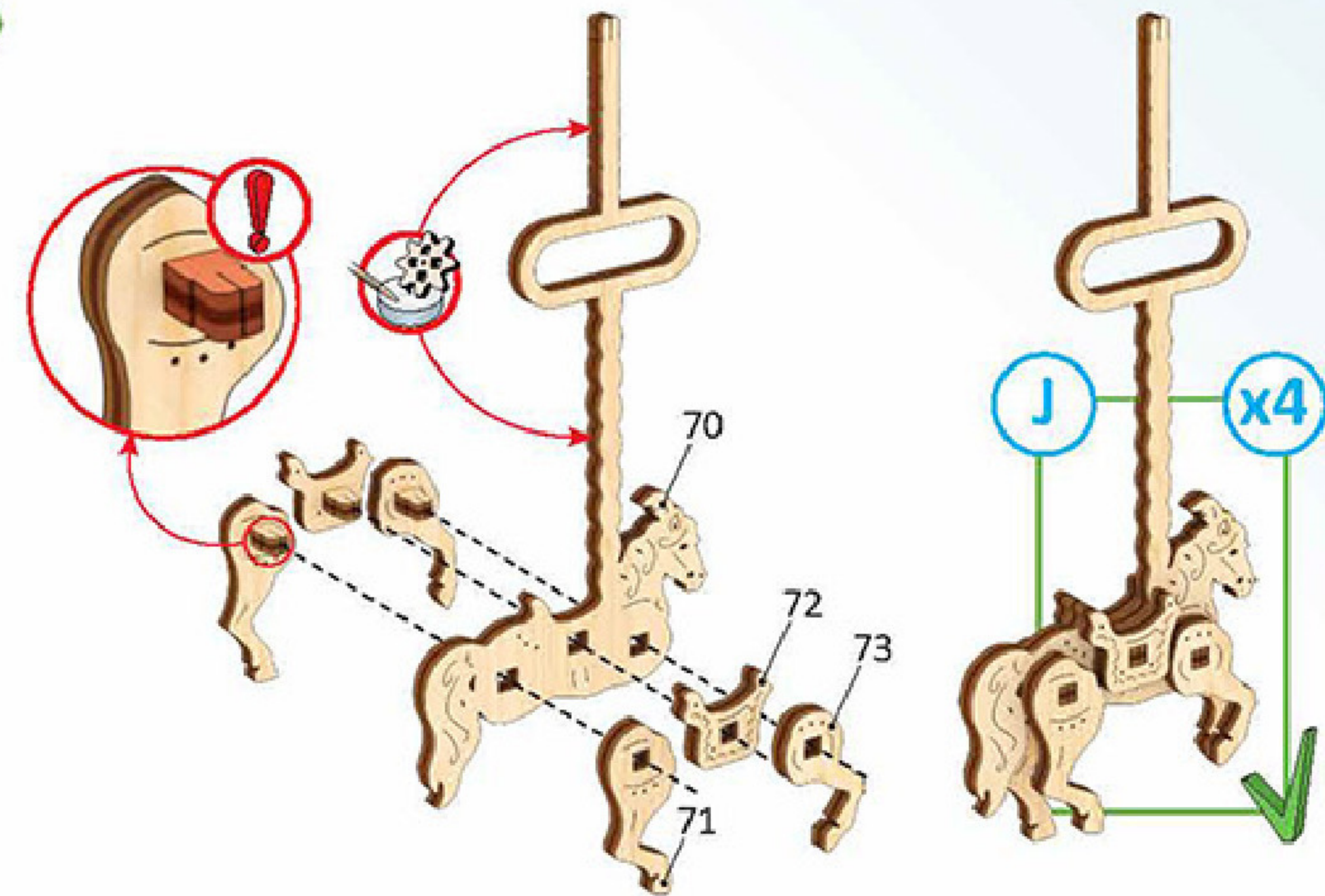

1

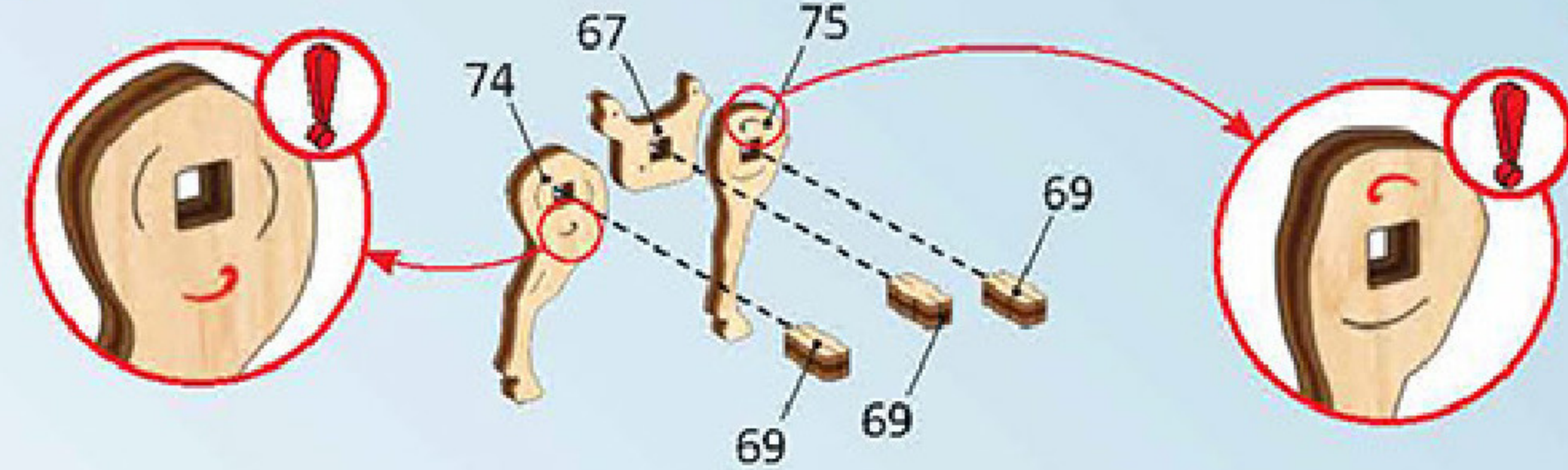

2

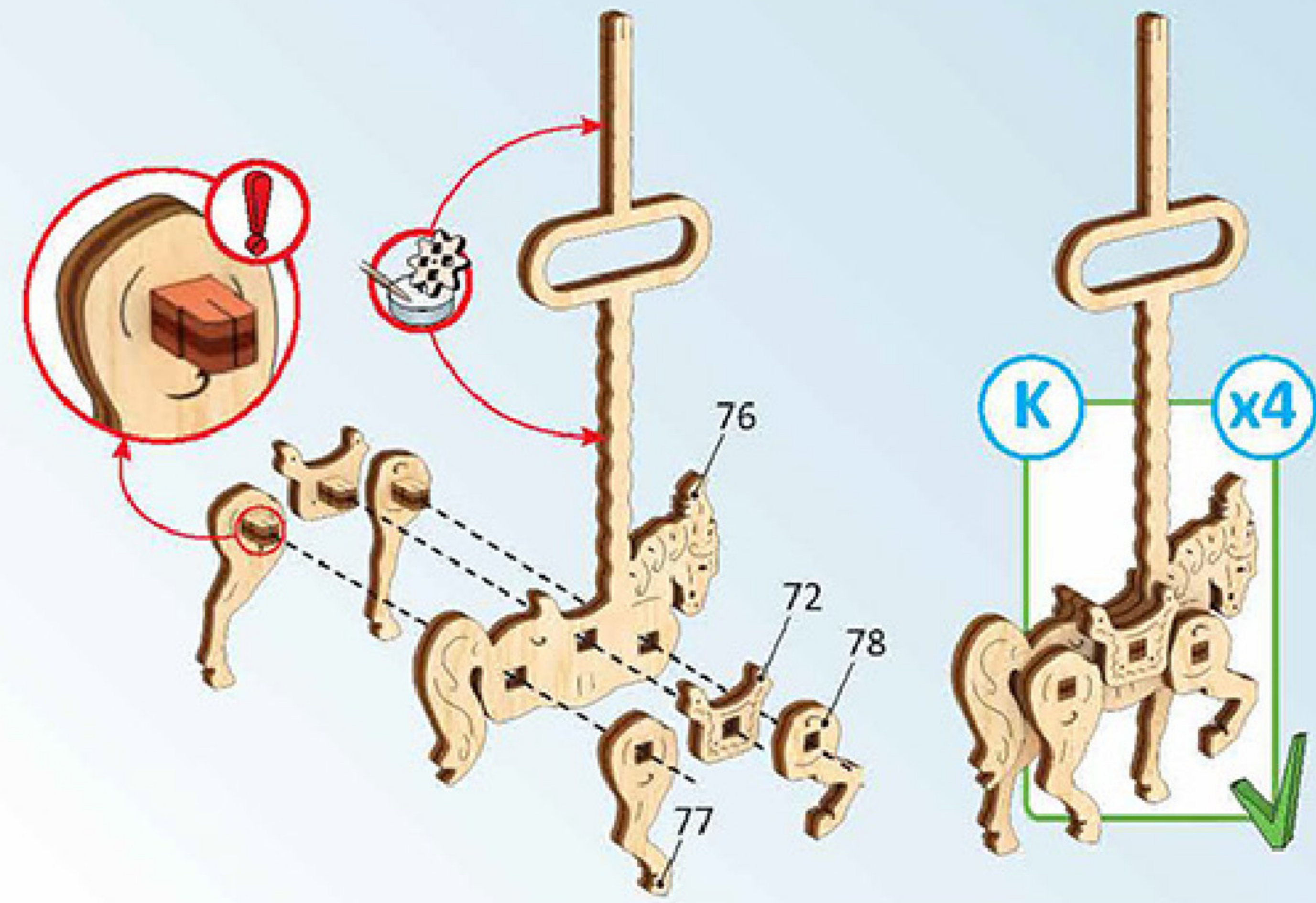



1

2

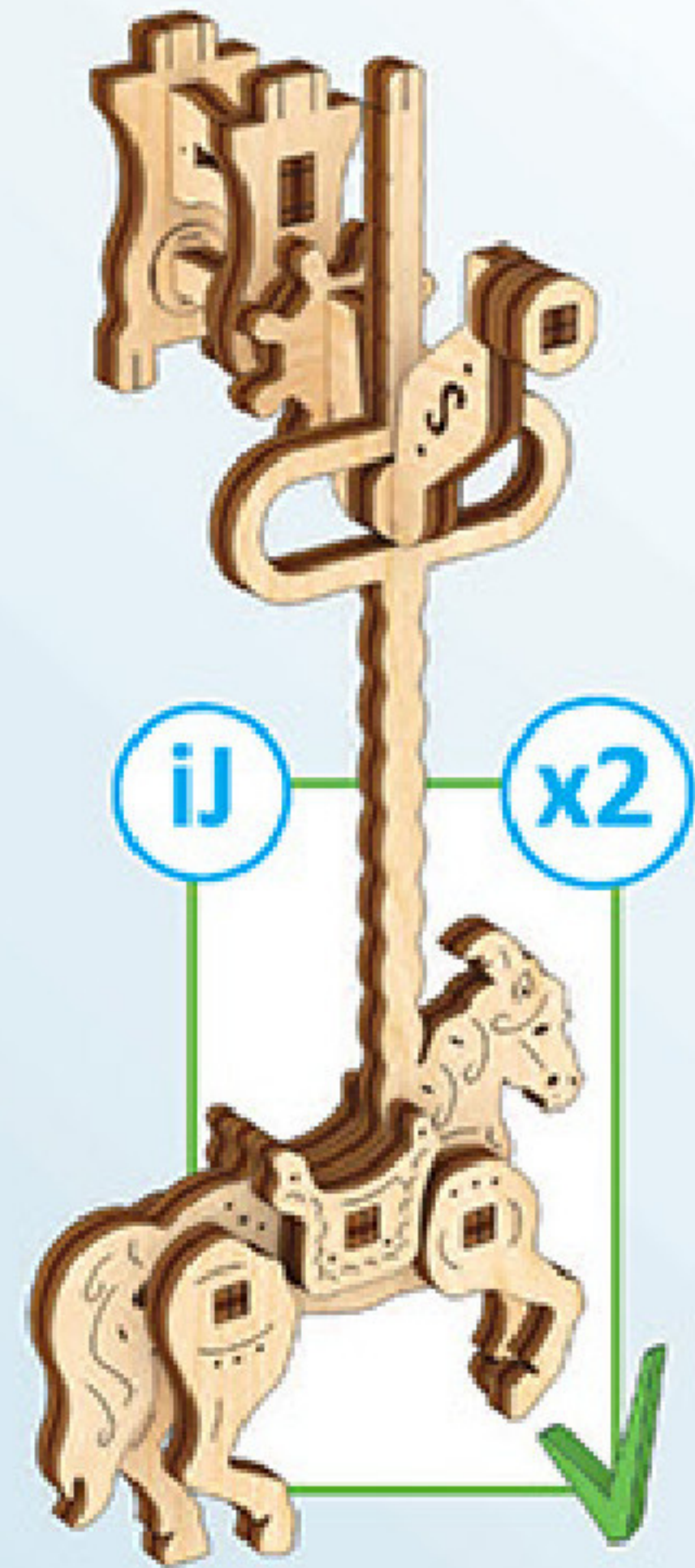
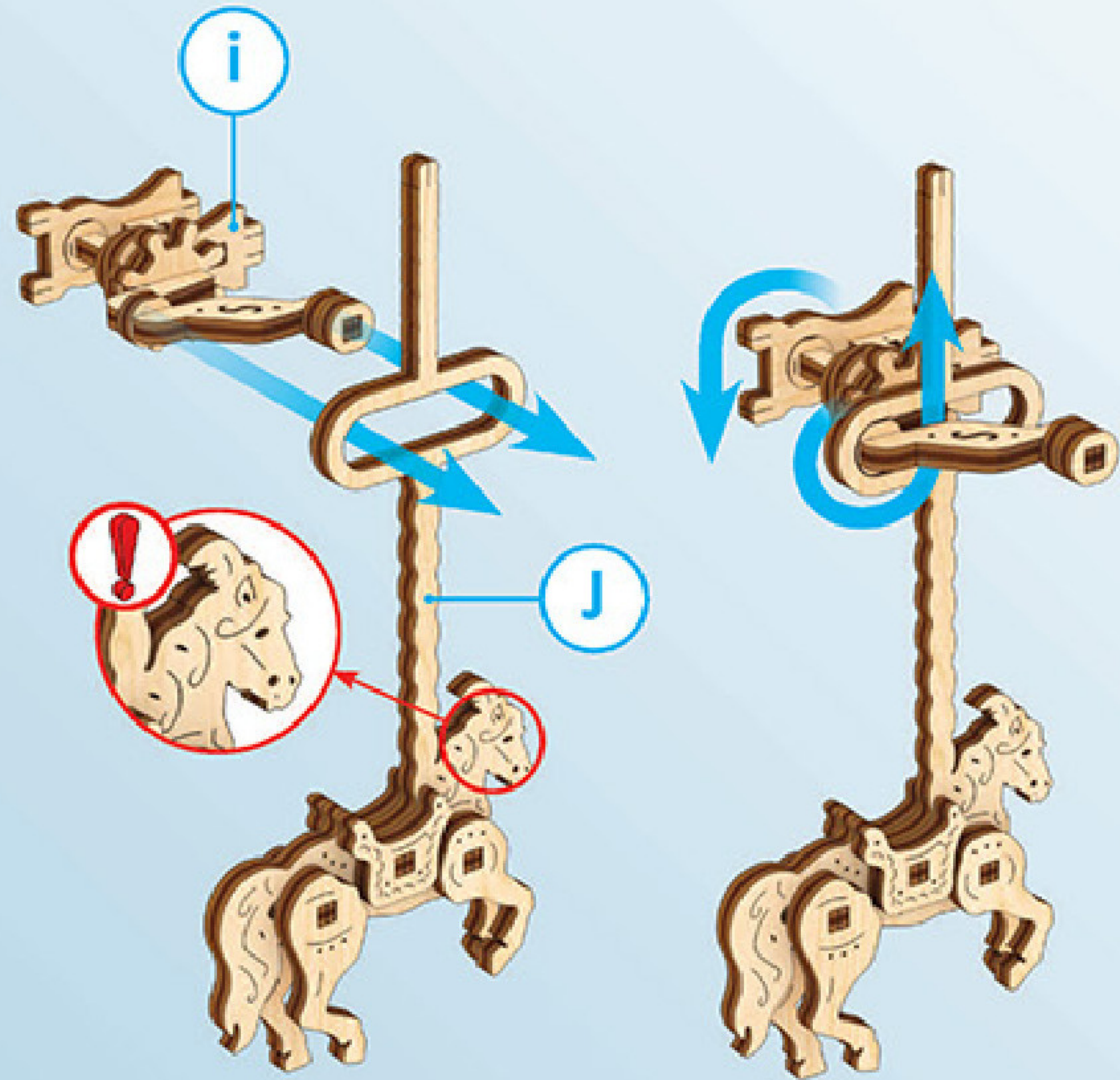

1

2

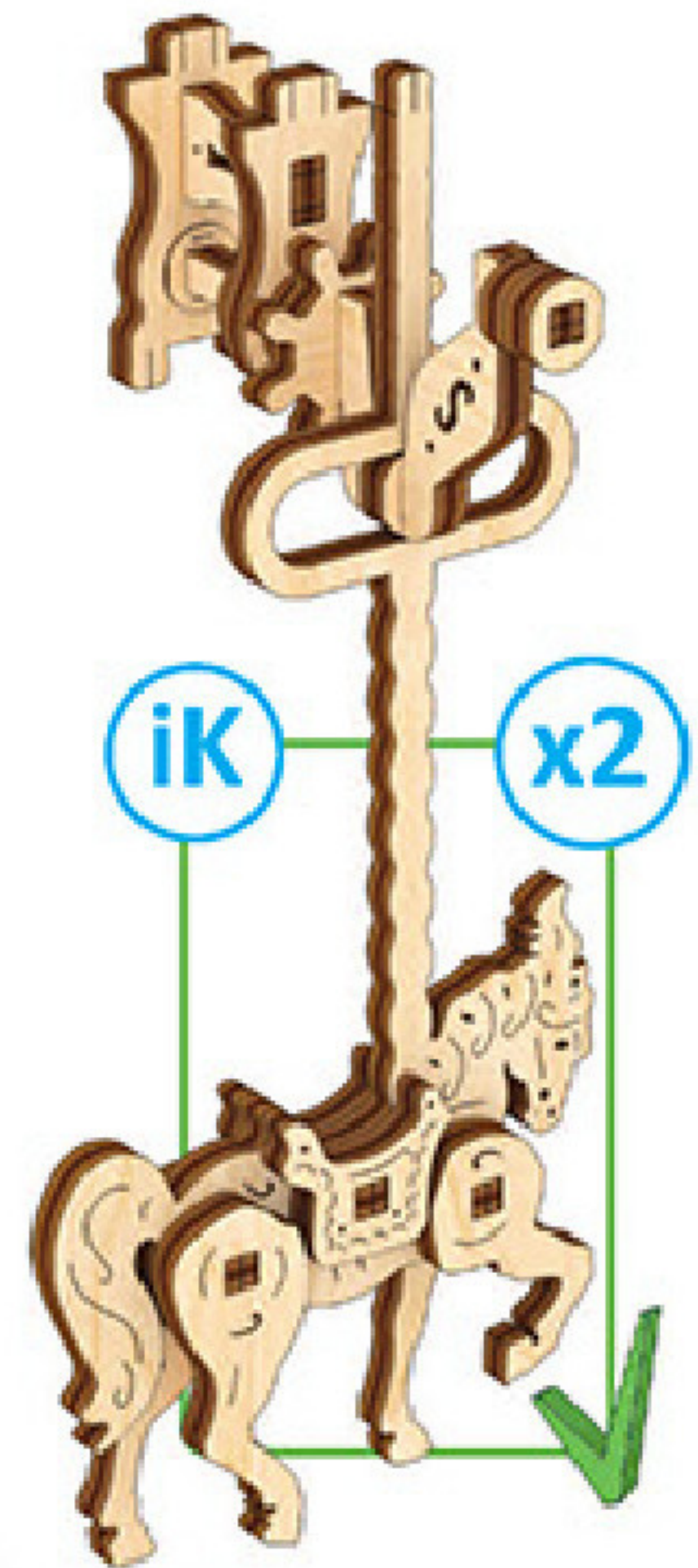
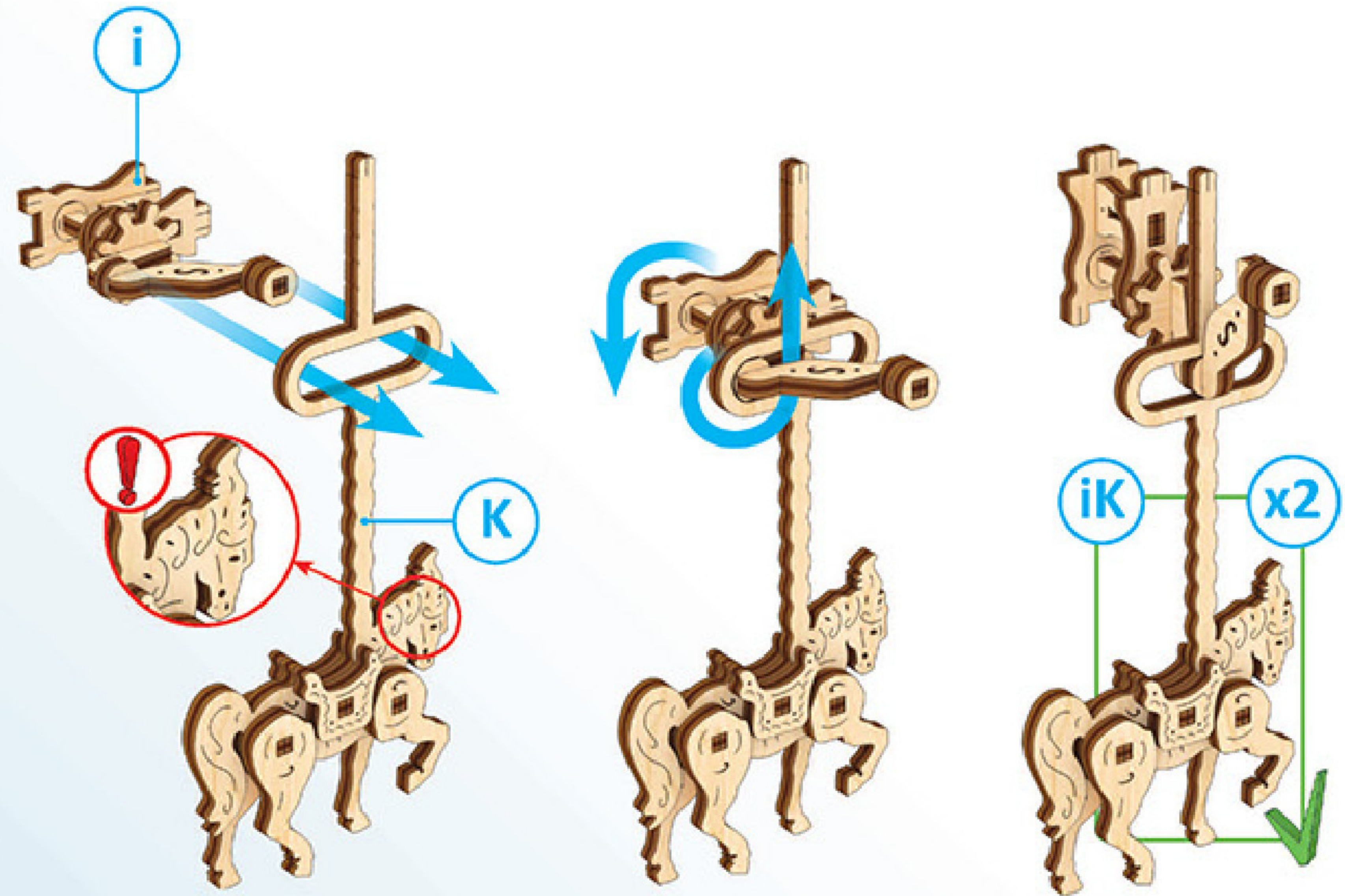



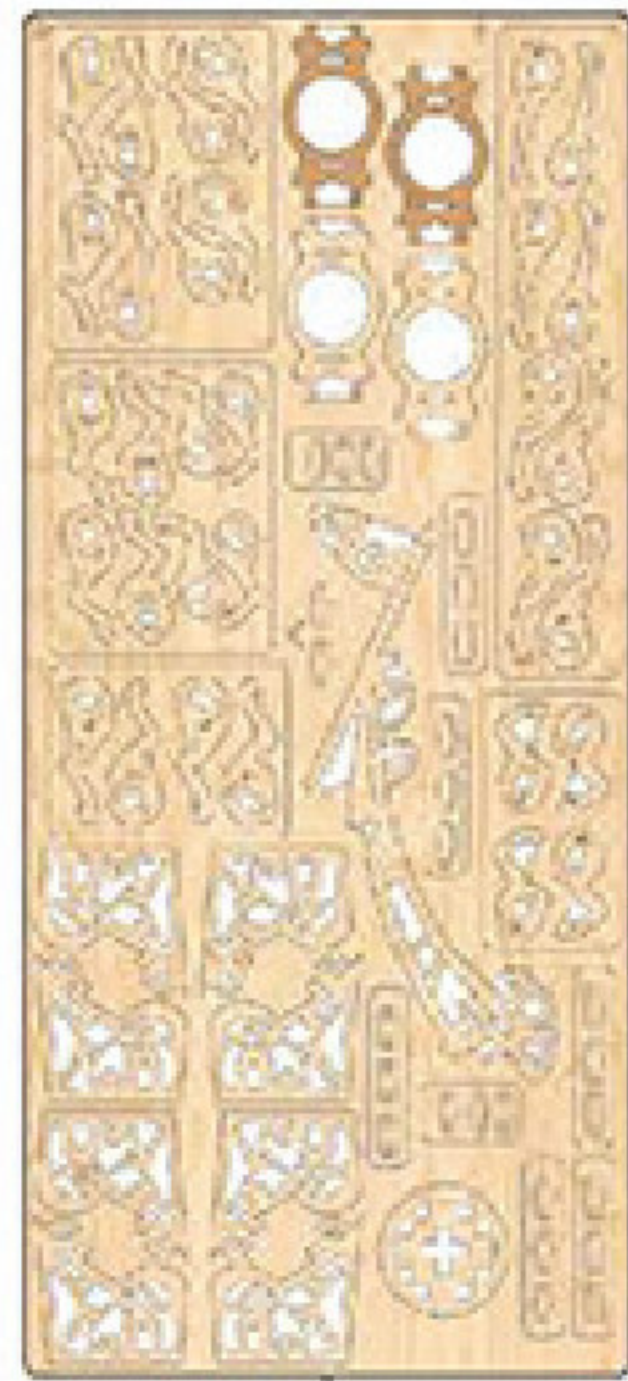

1

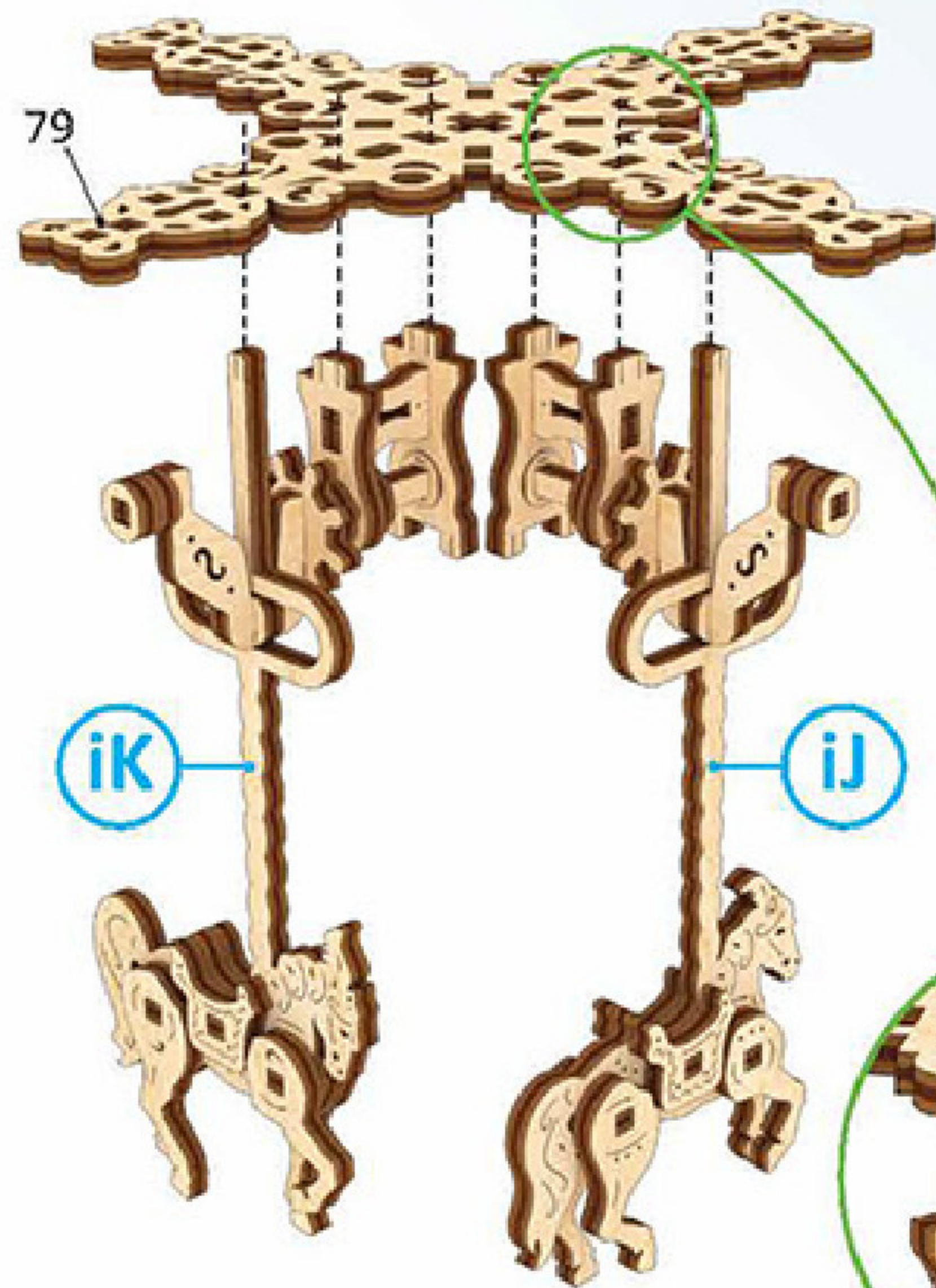

2

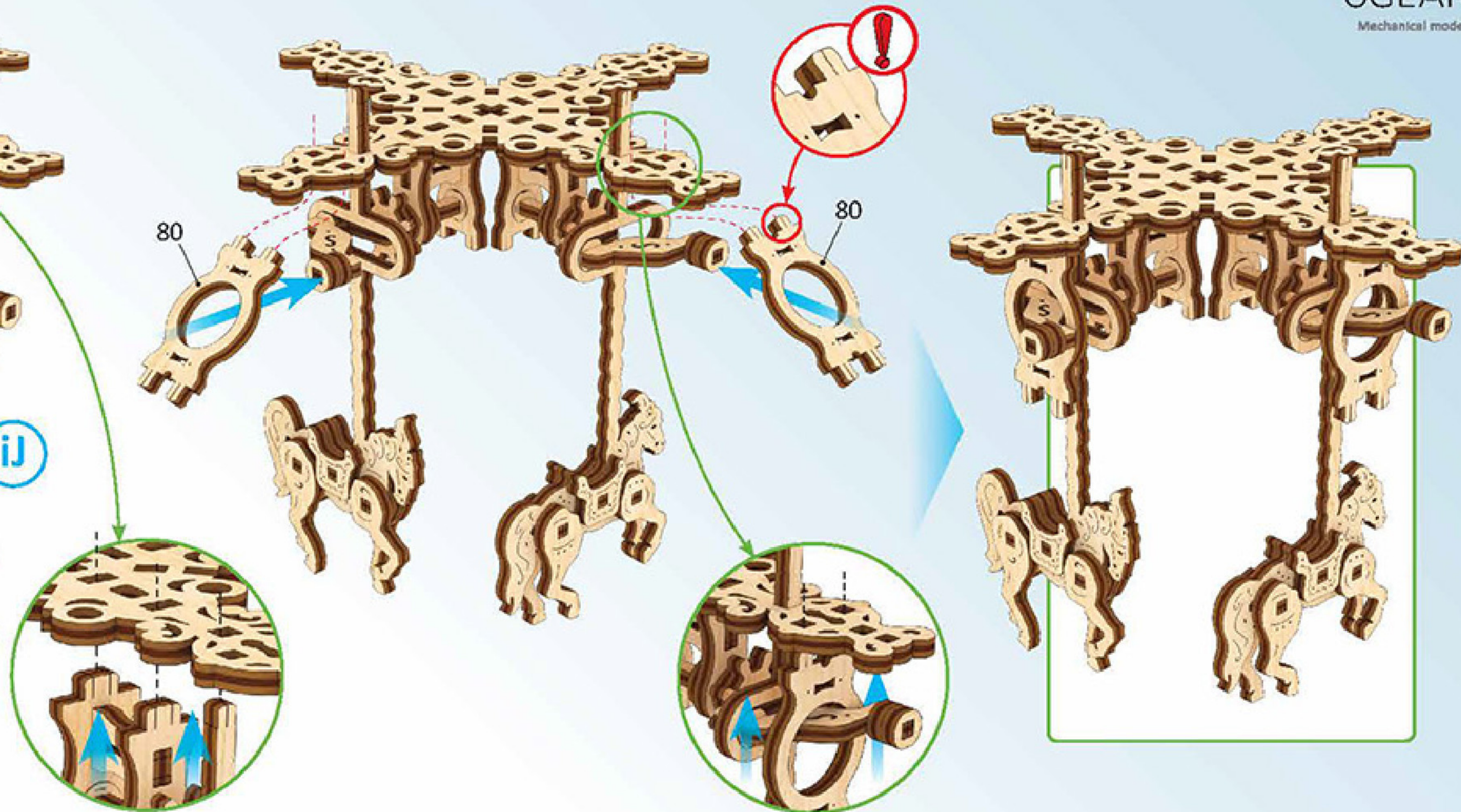



3

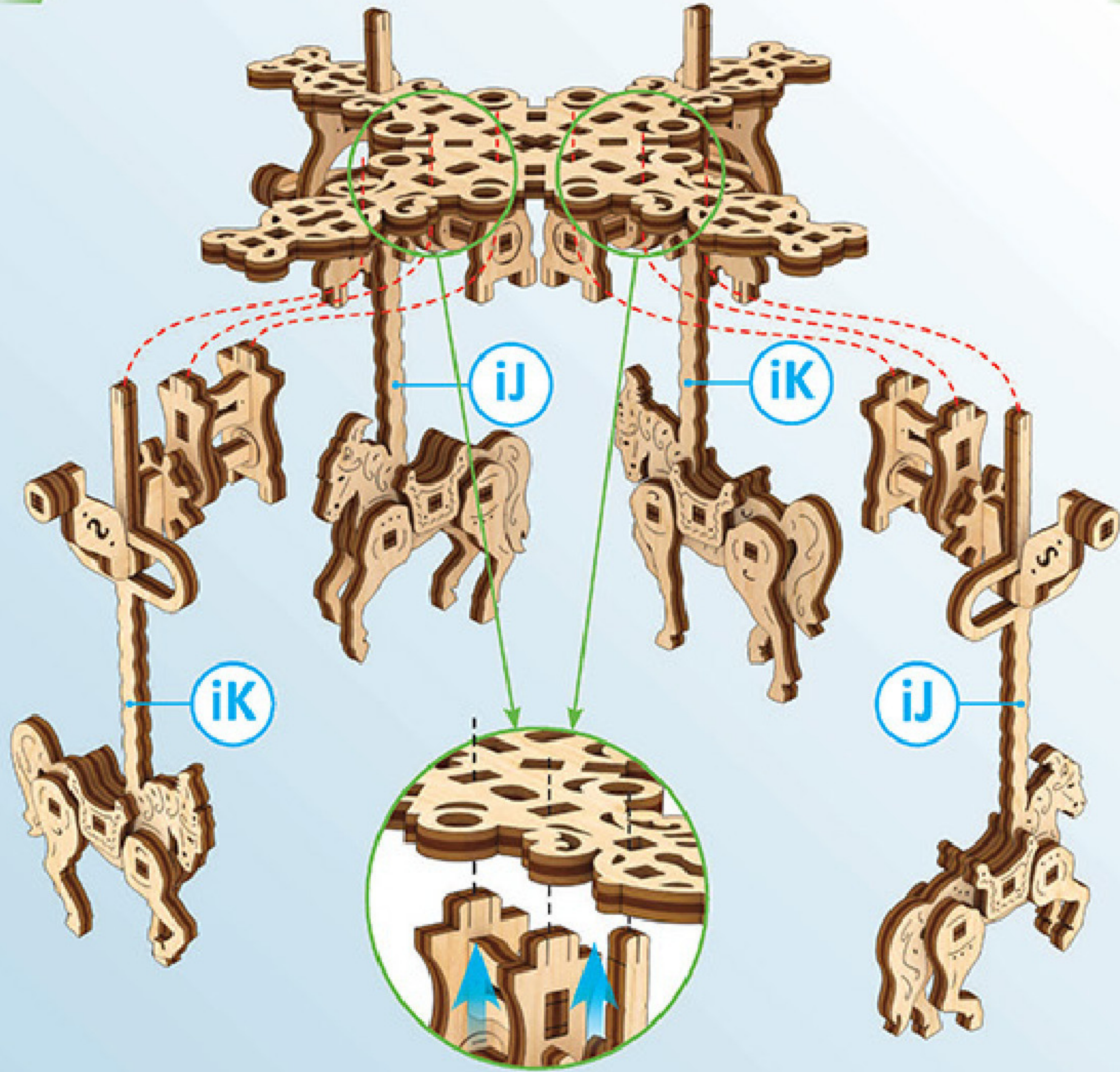
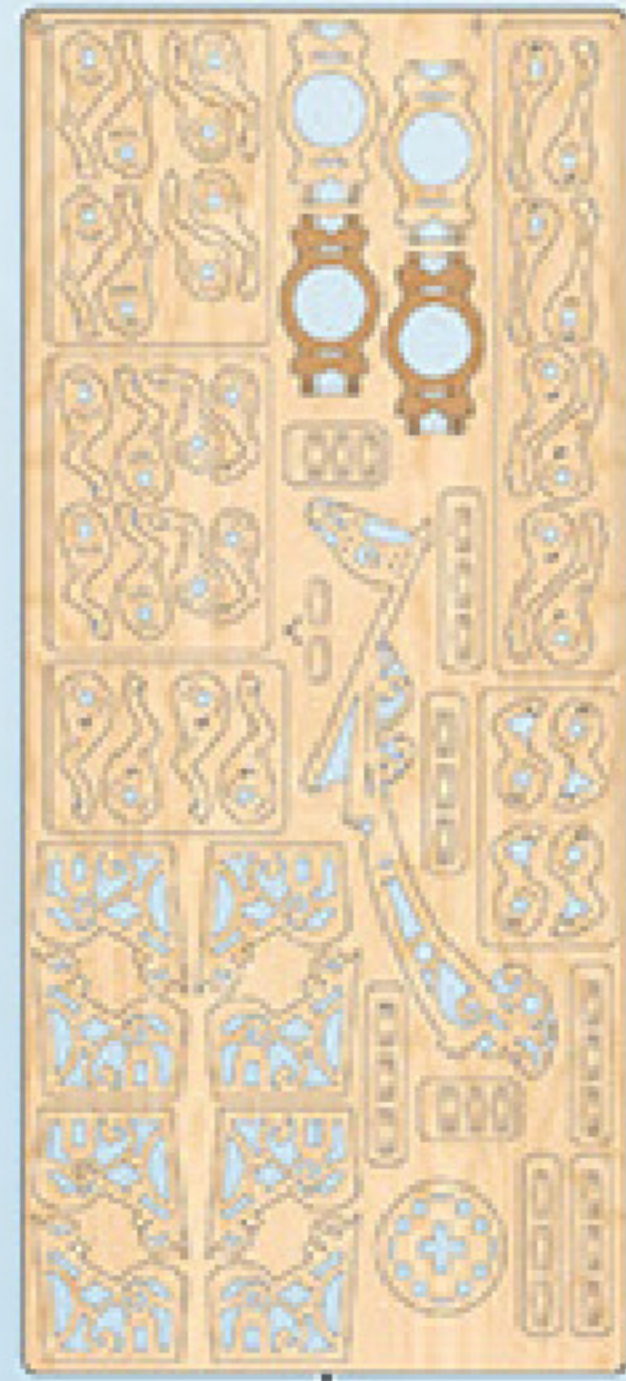

4

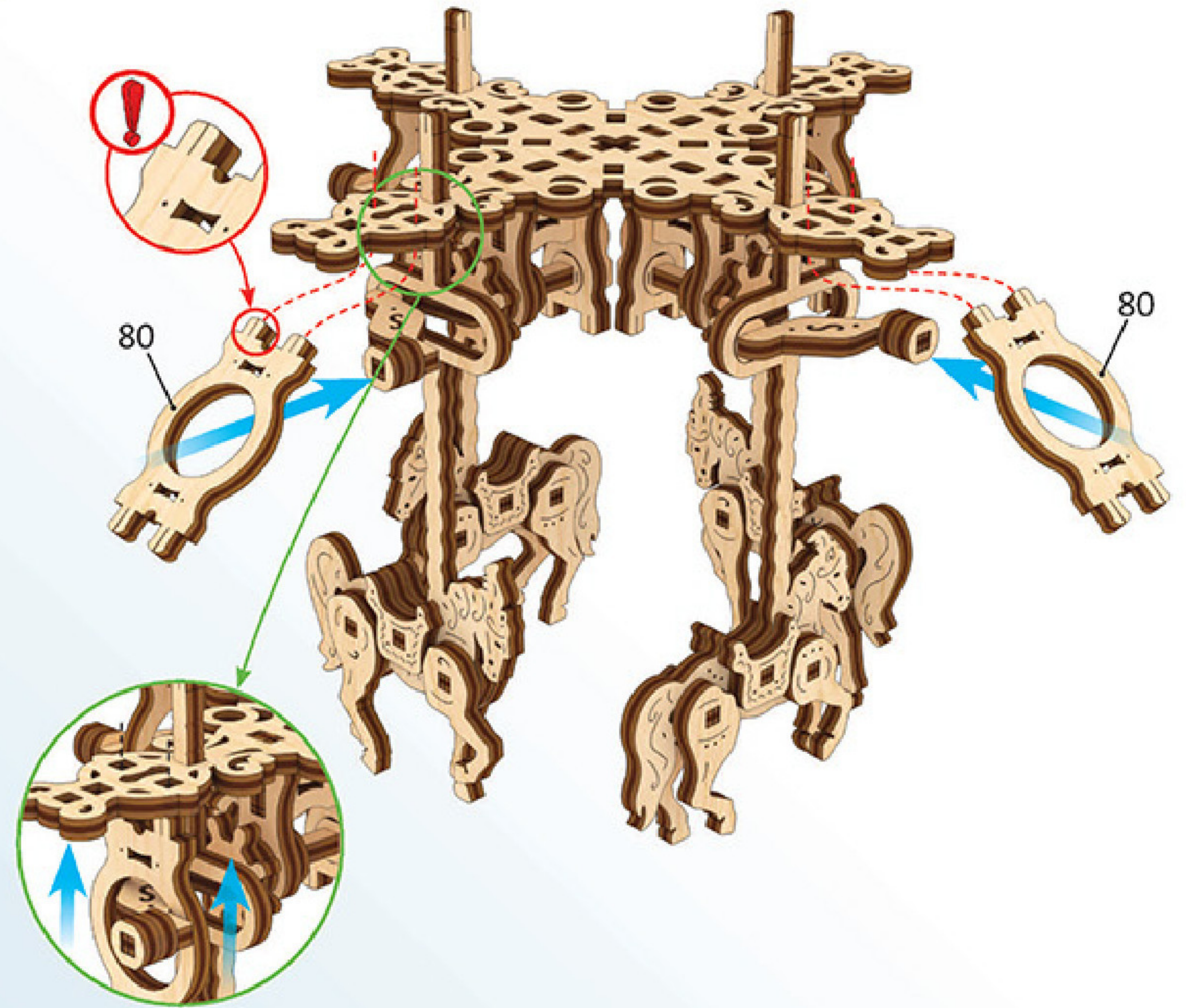



5

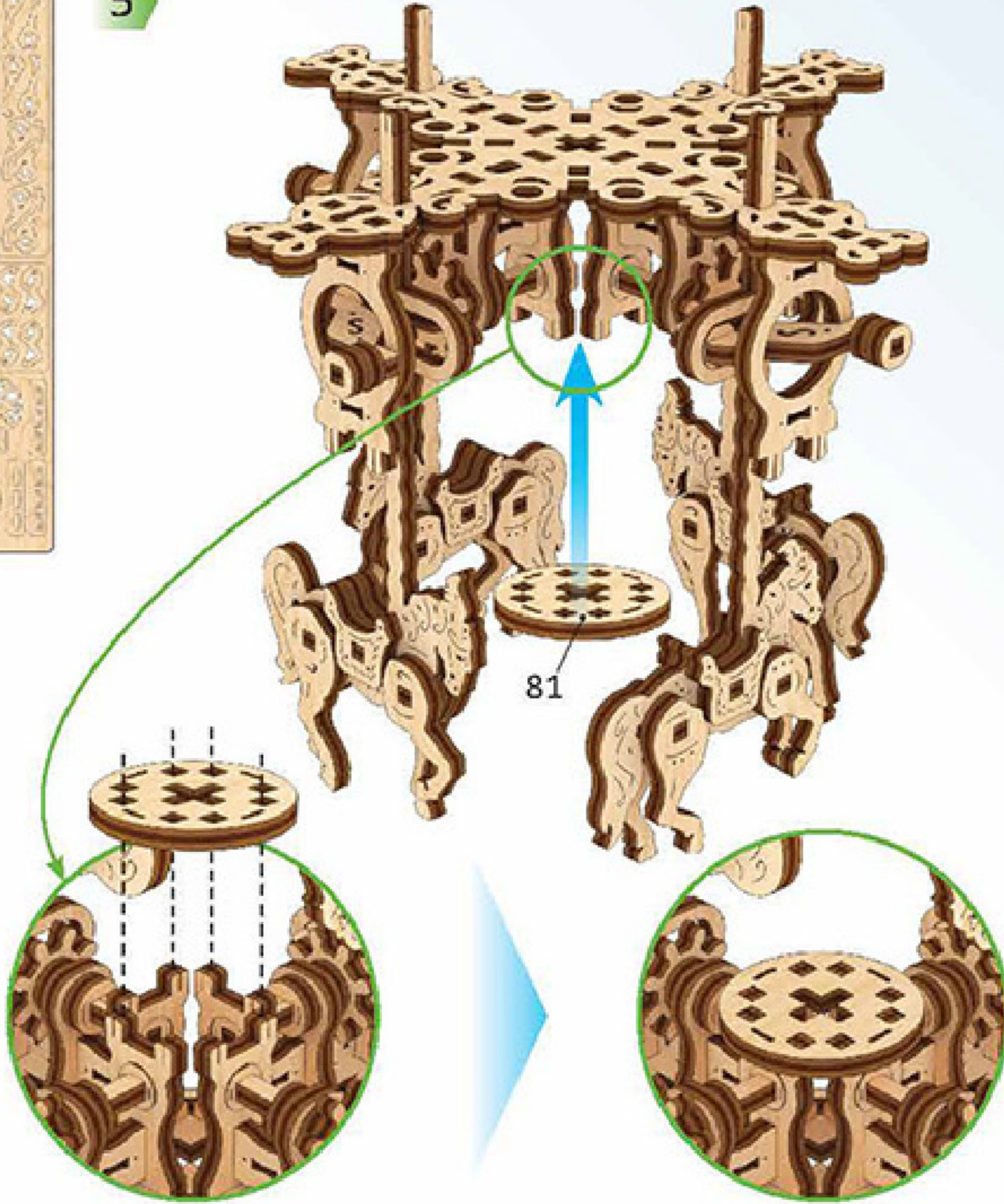

6

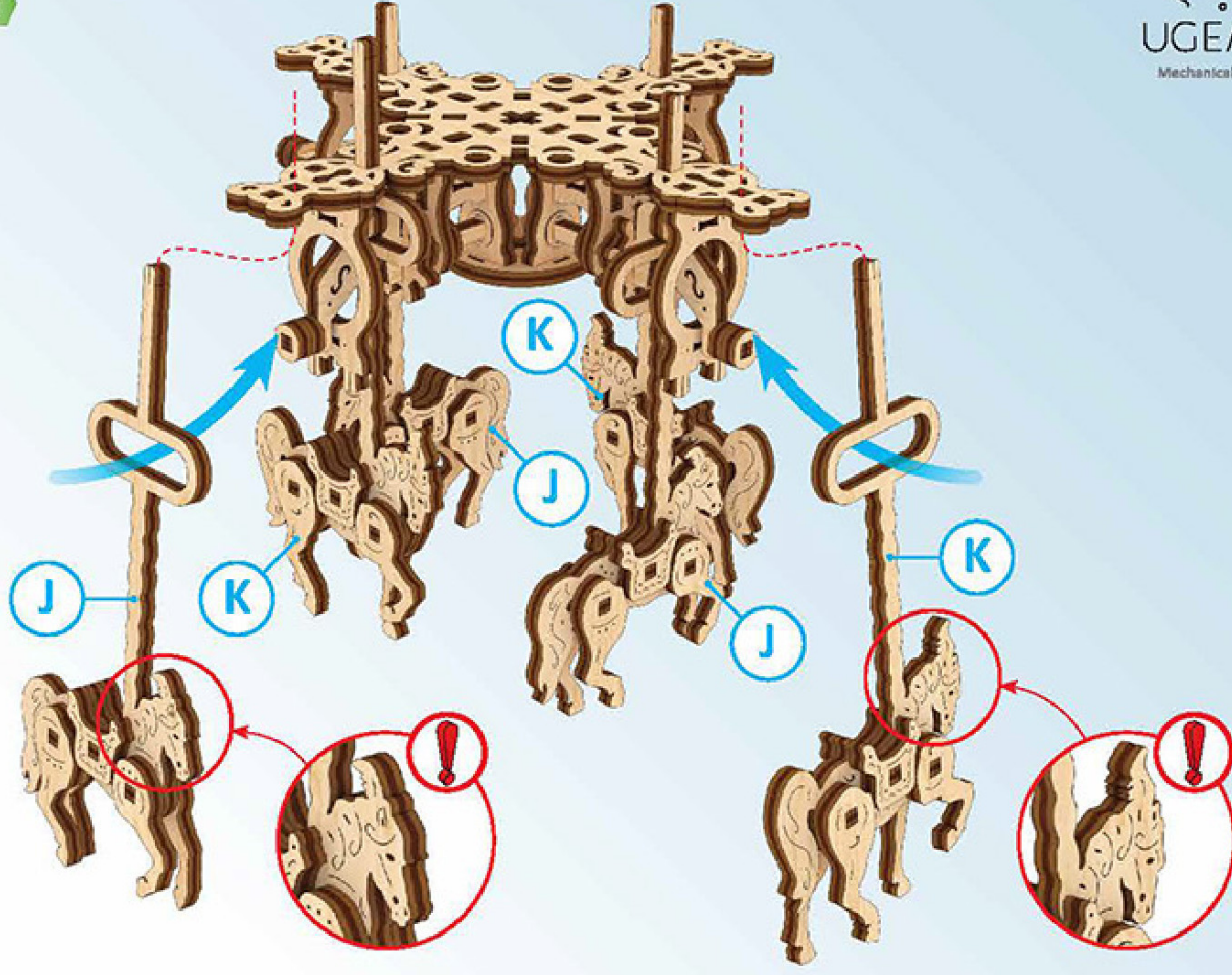



7

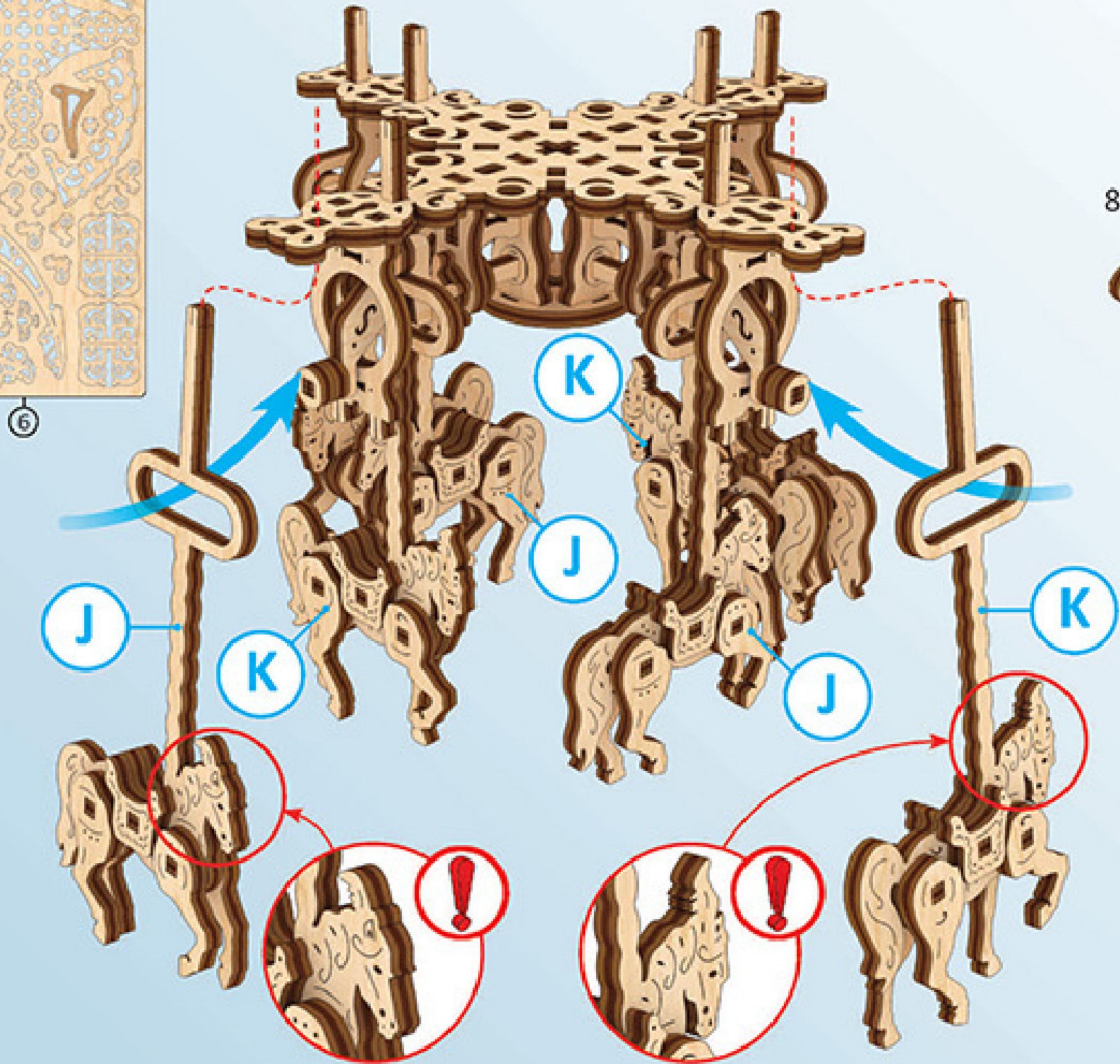

8

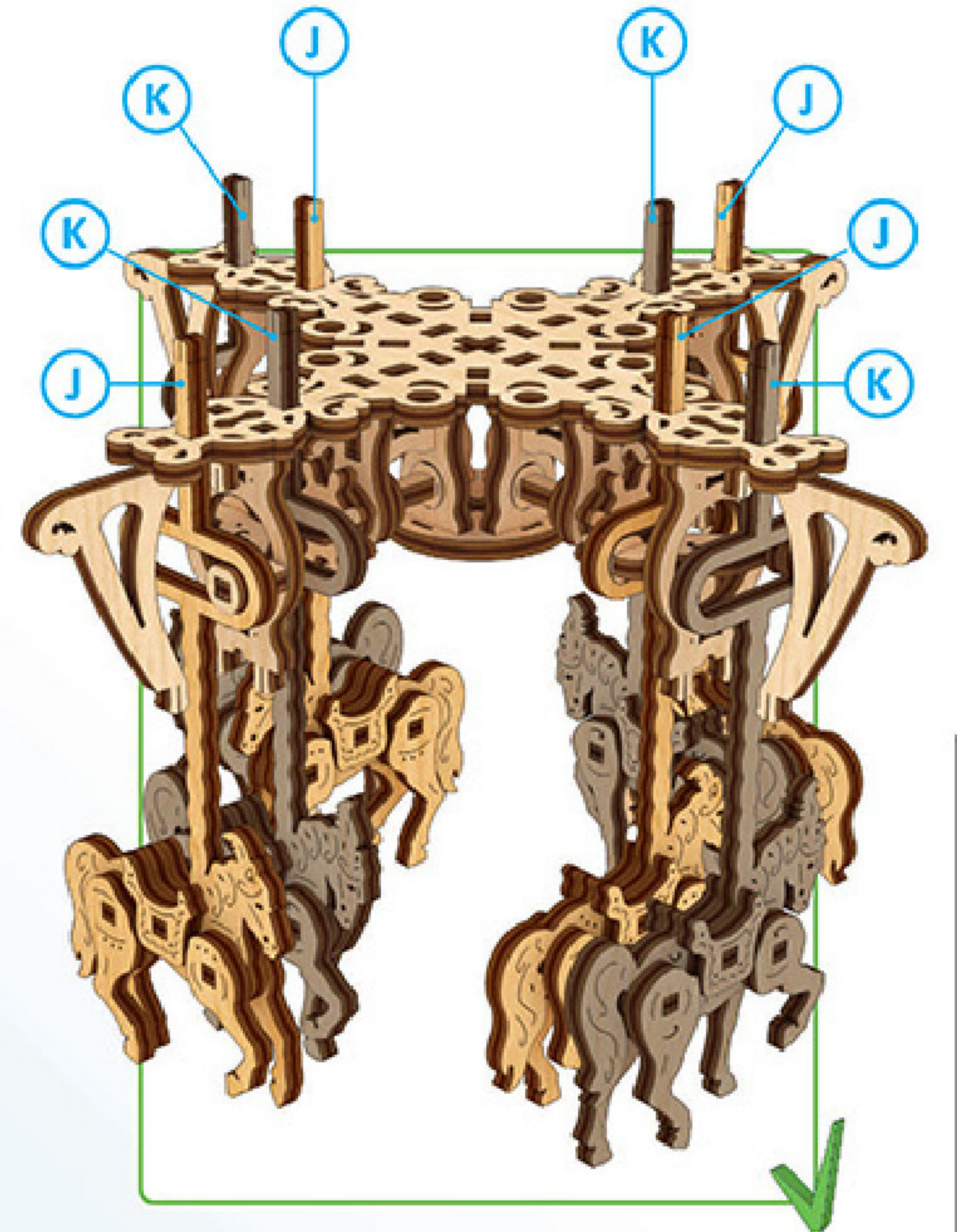
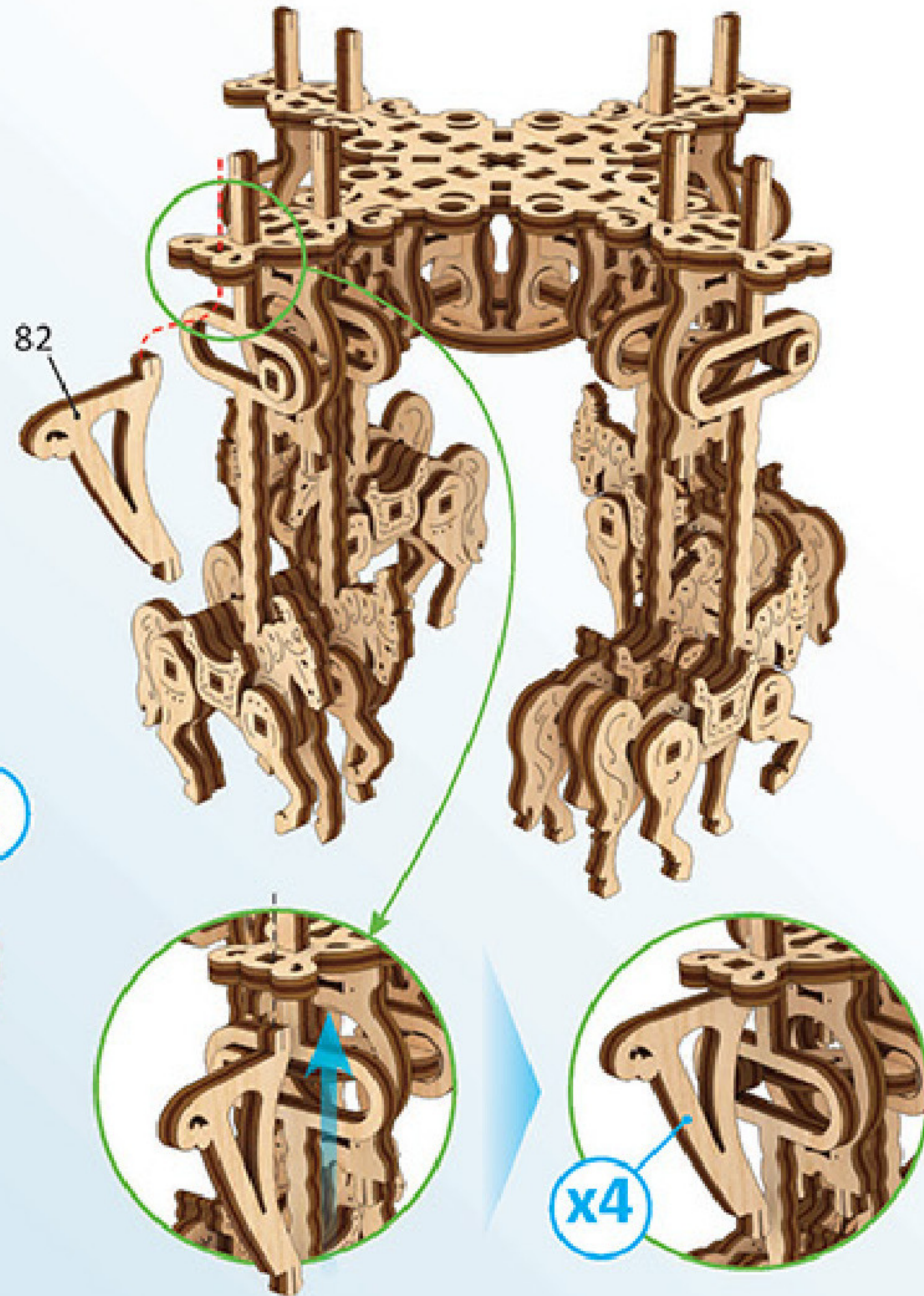





5



6

1

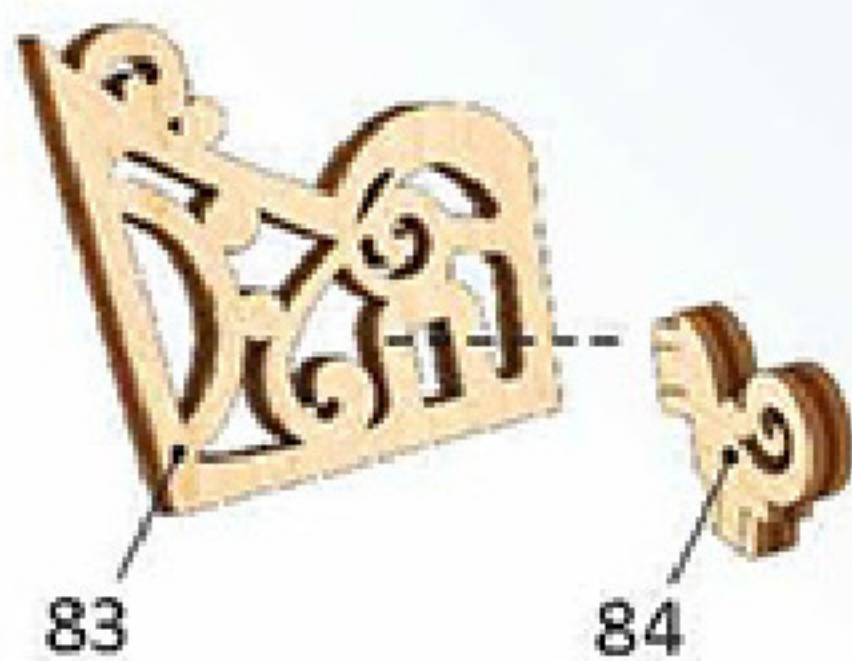

83

84



L

x4

1

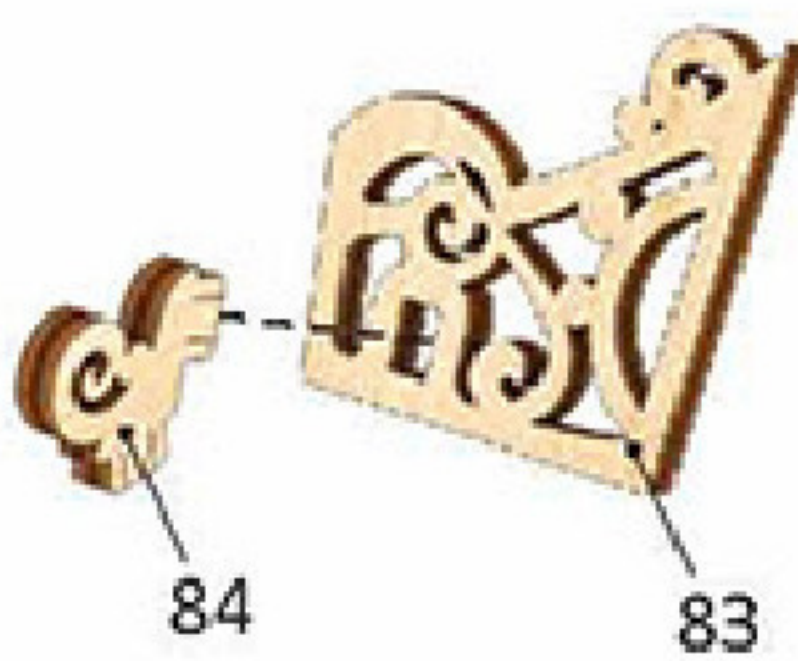

84

83



M

x4

1

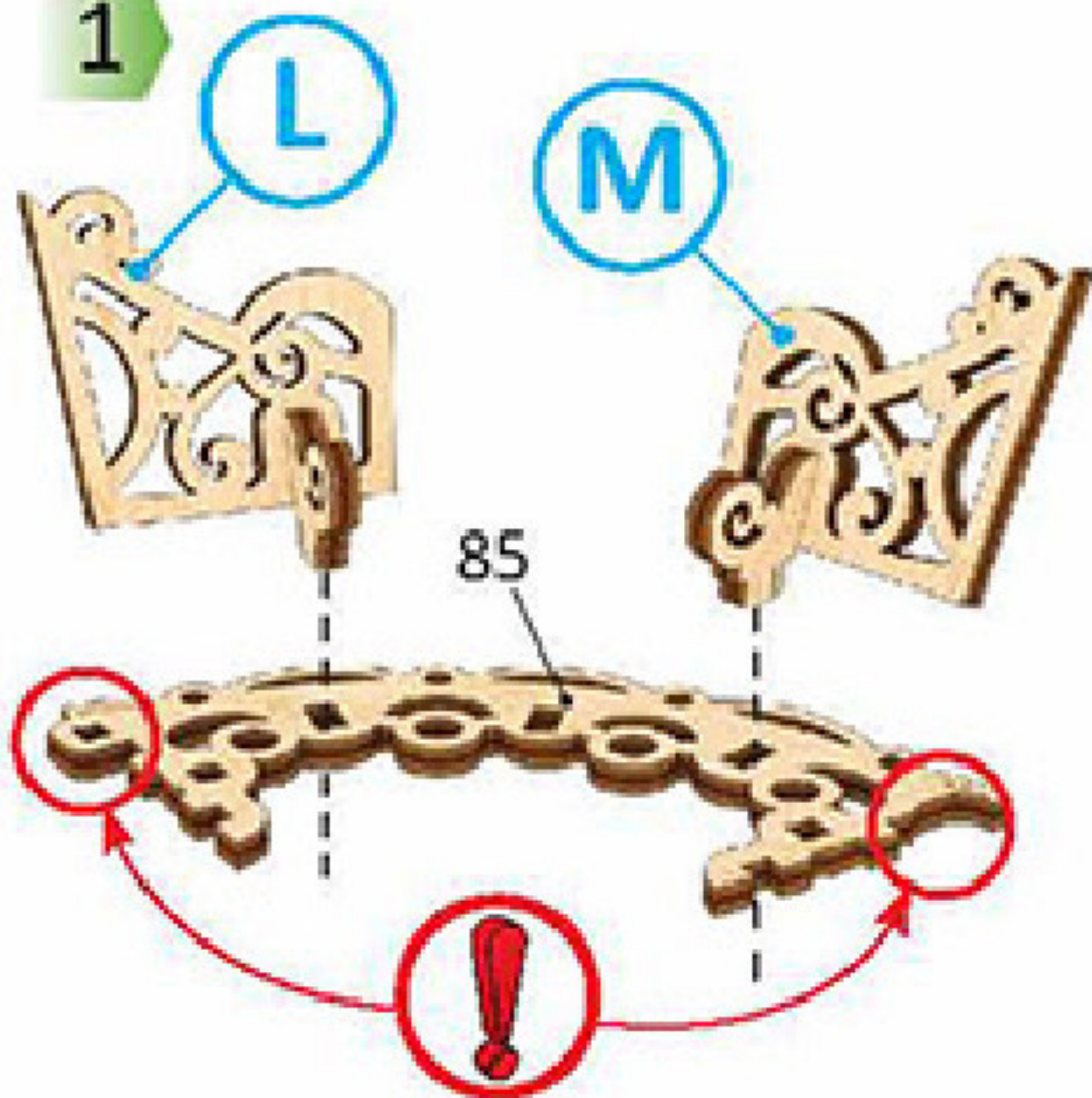

L

M

85



N

x4

1

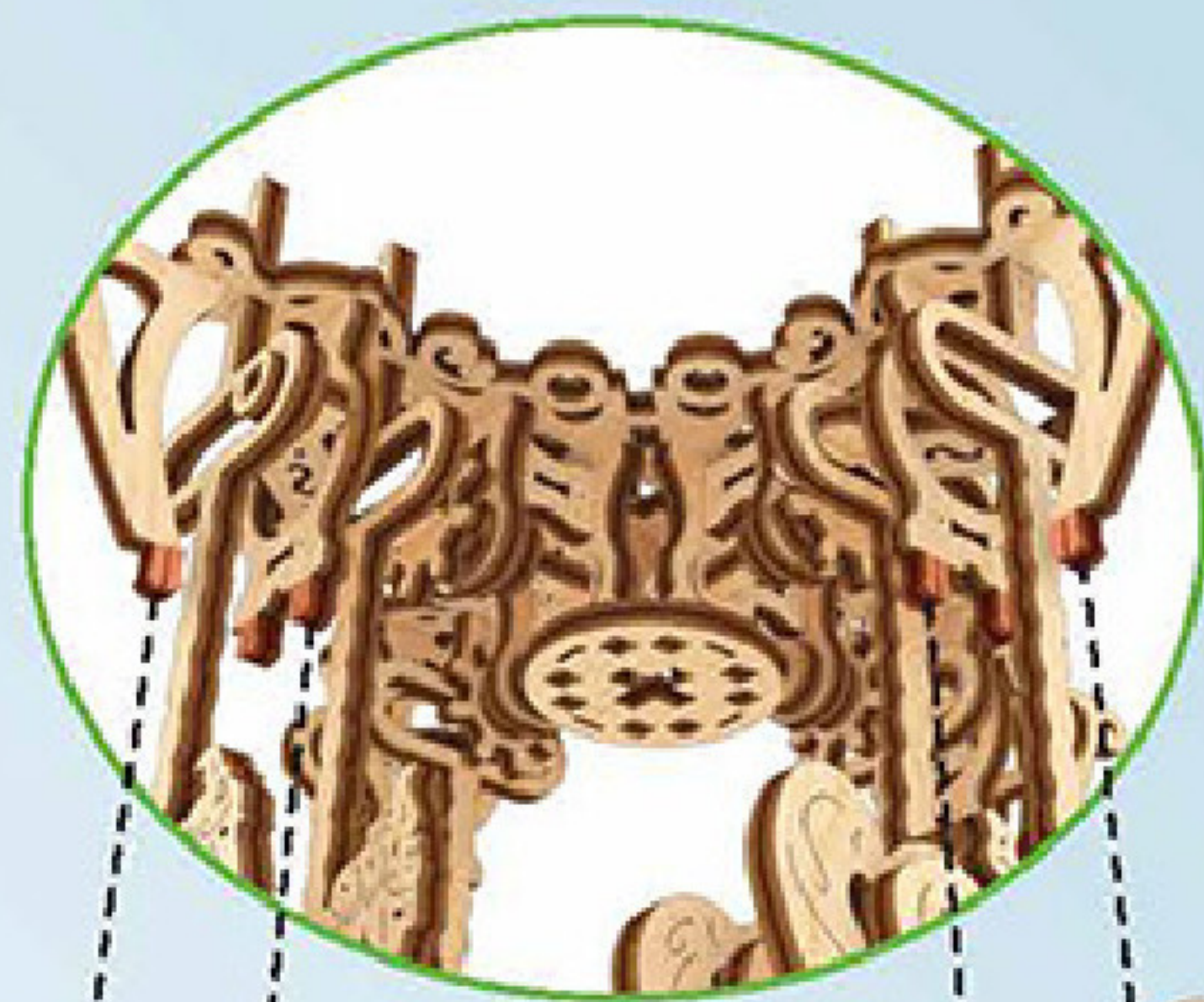



2

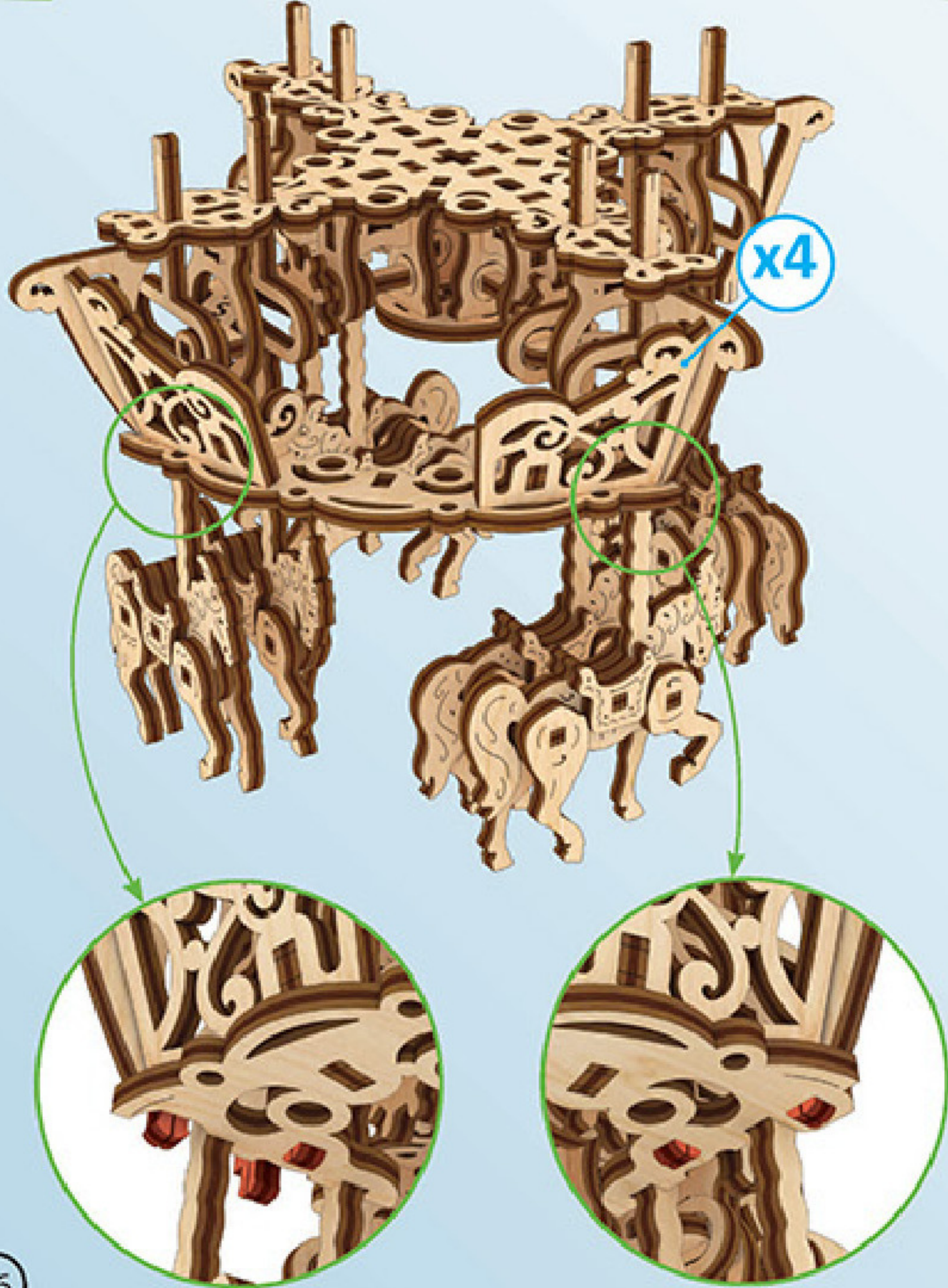

3

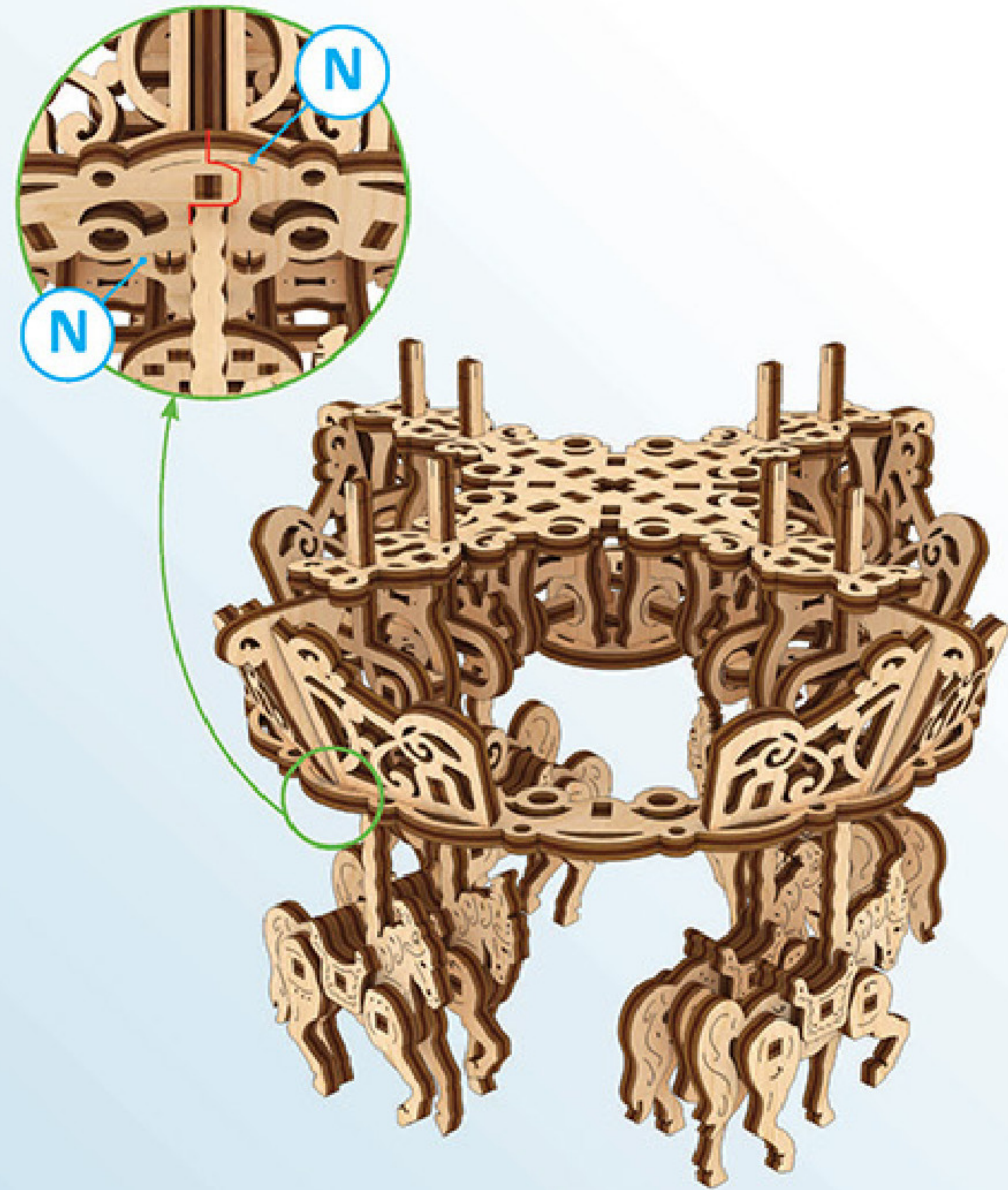

4

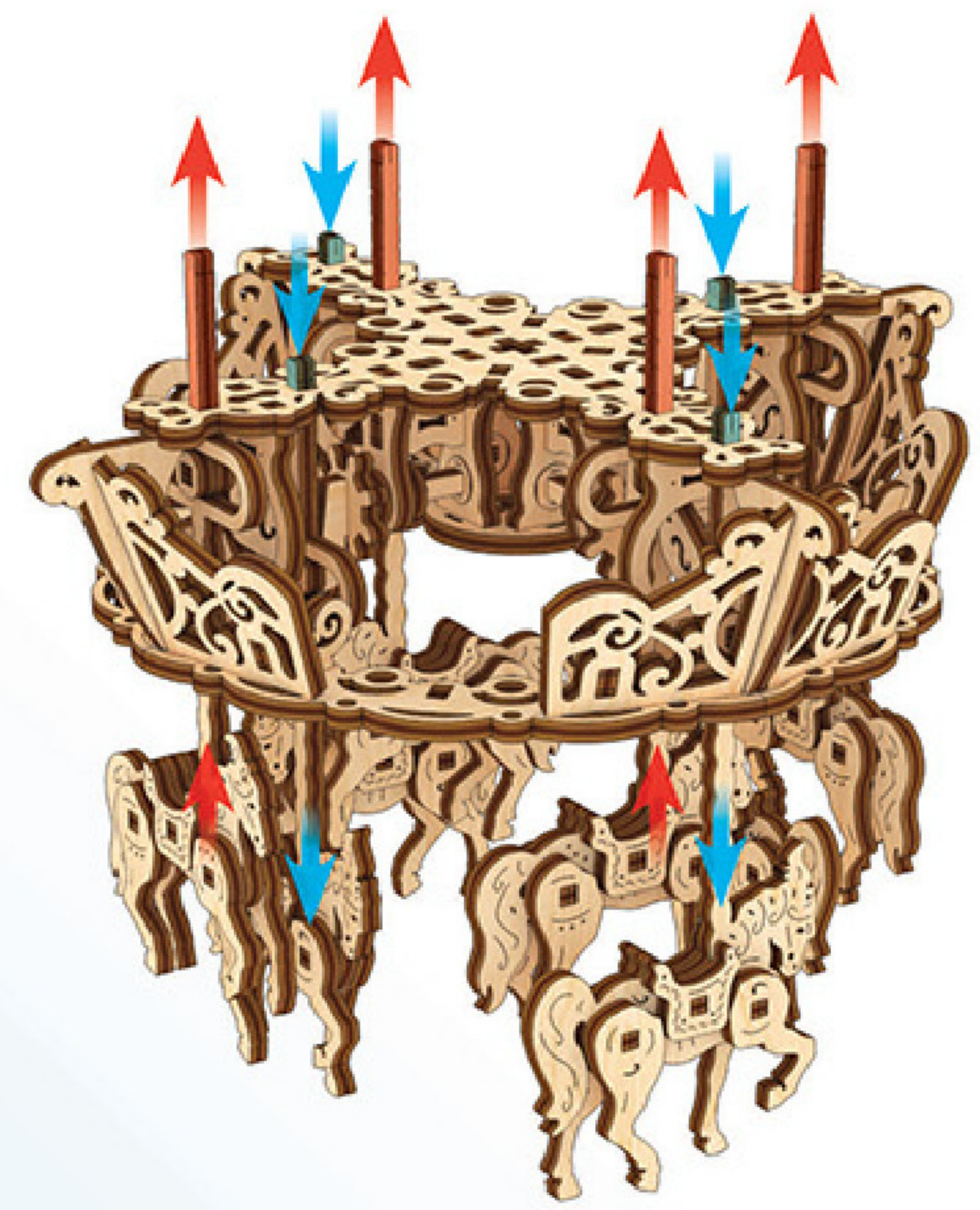



5



6

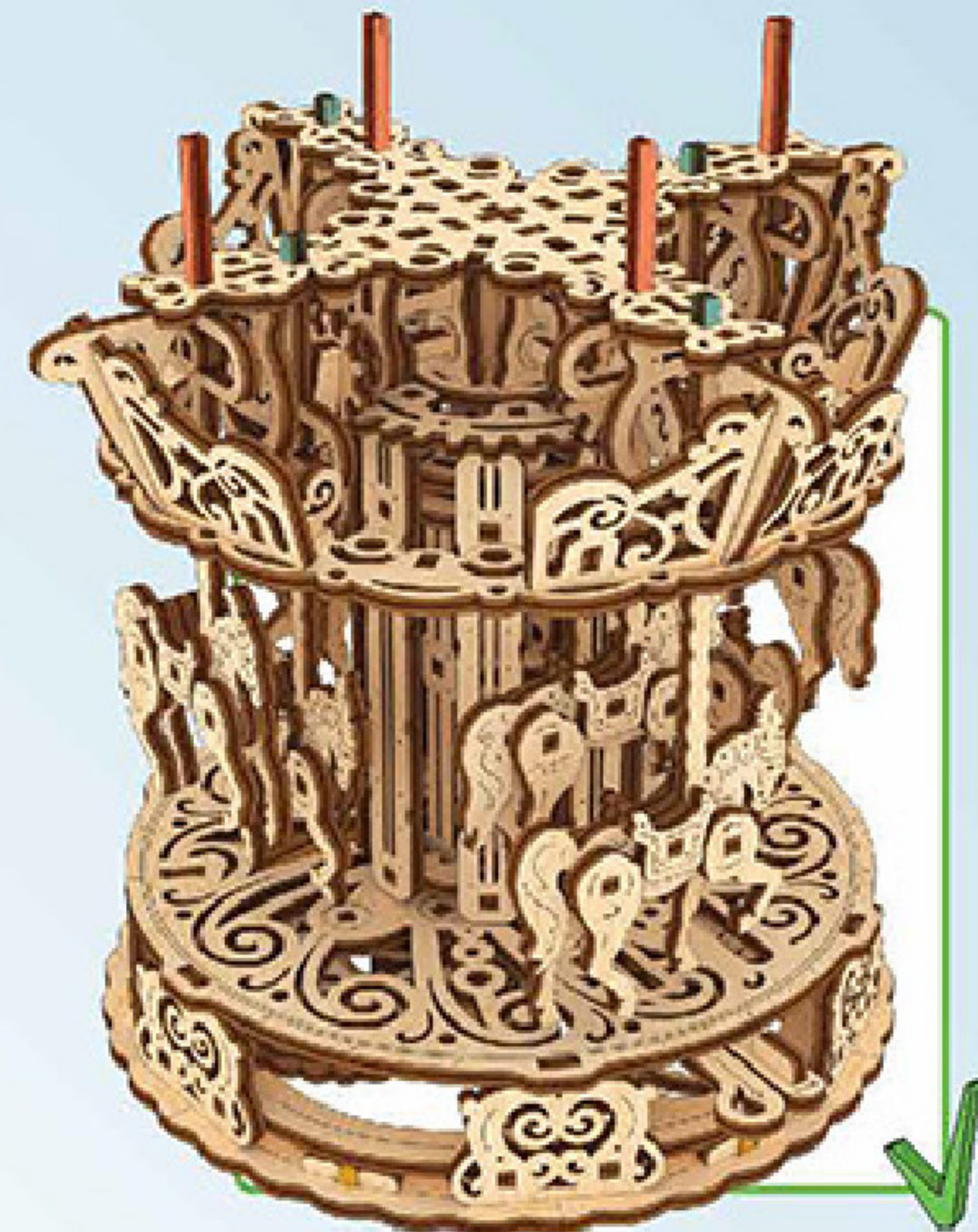
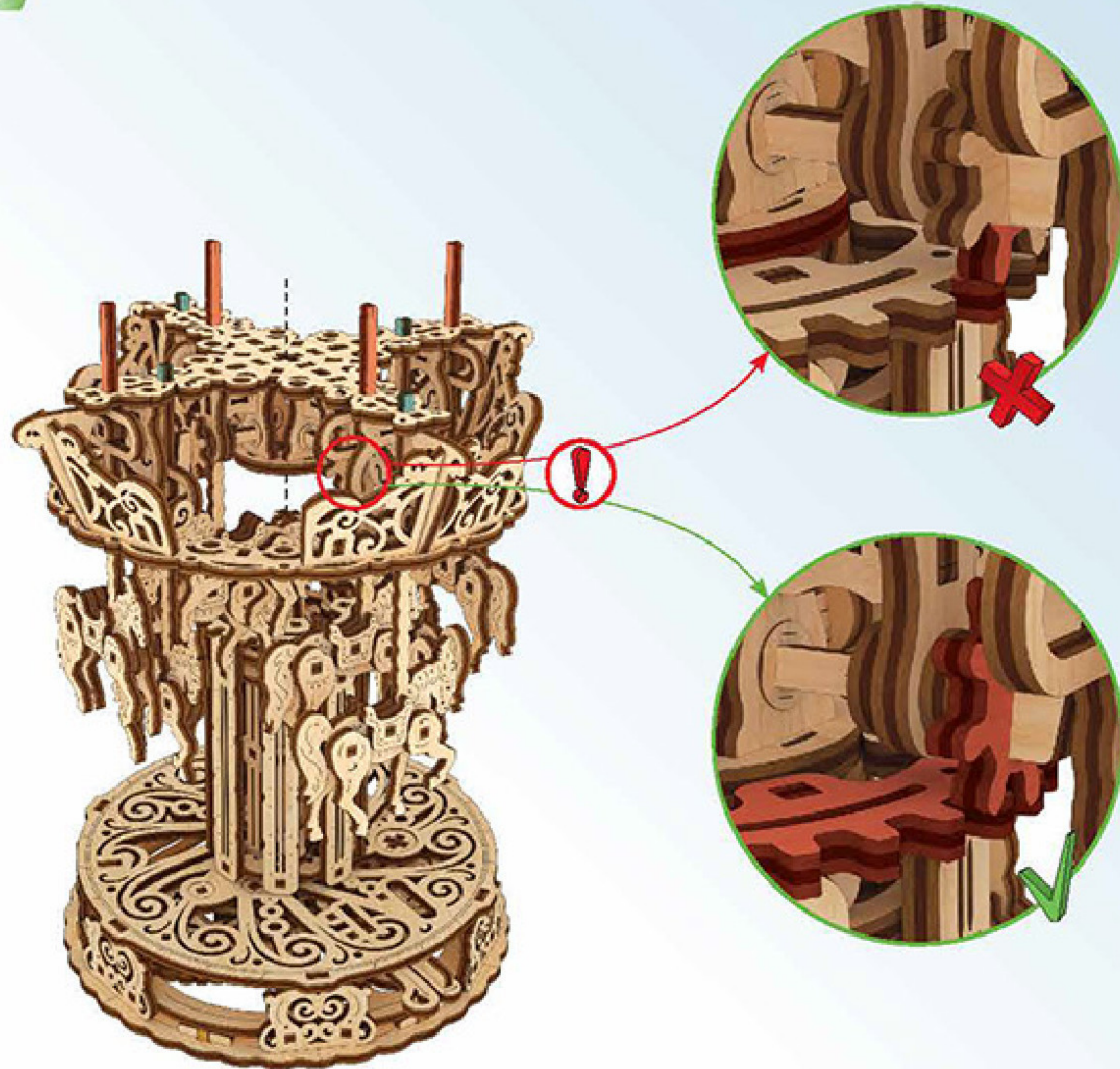



1

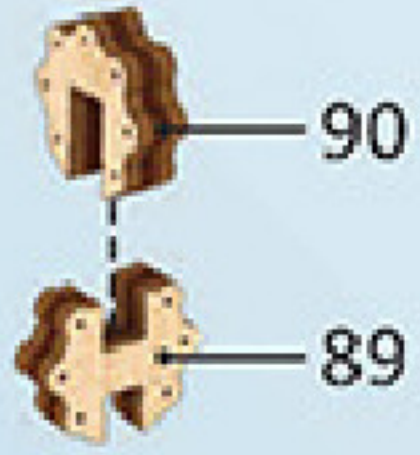

6

2



3



4





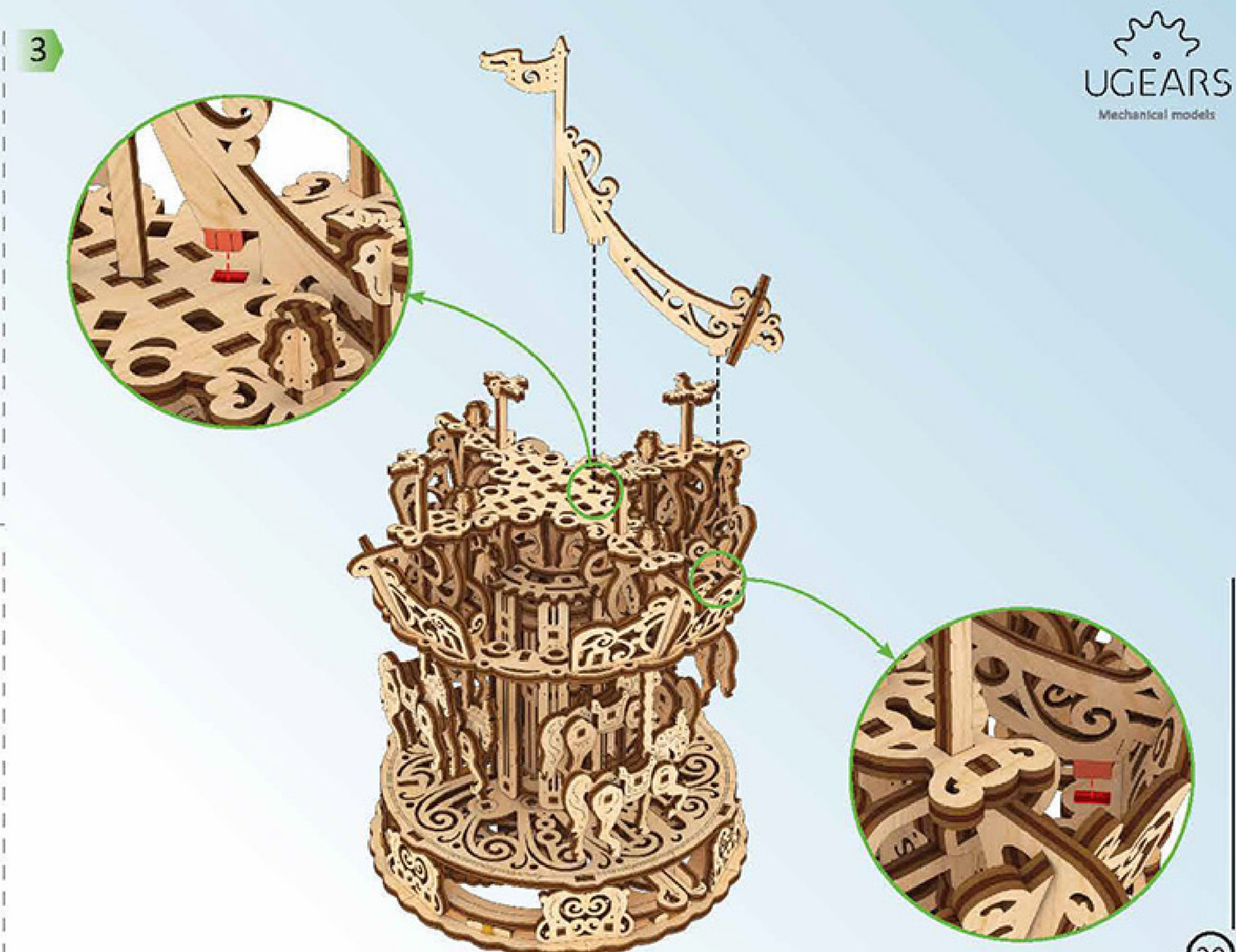
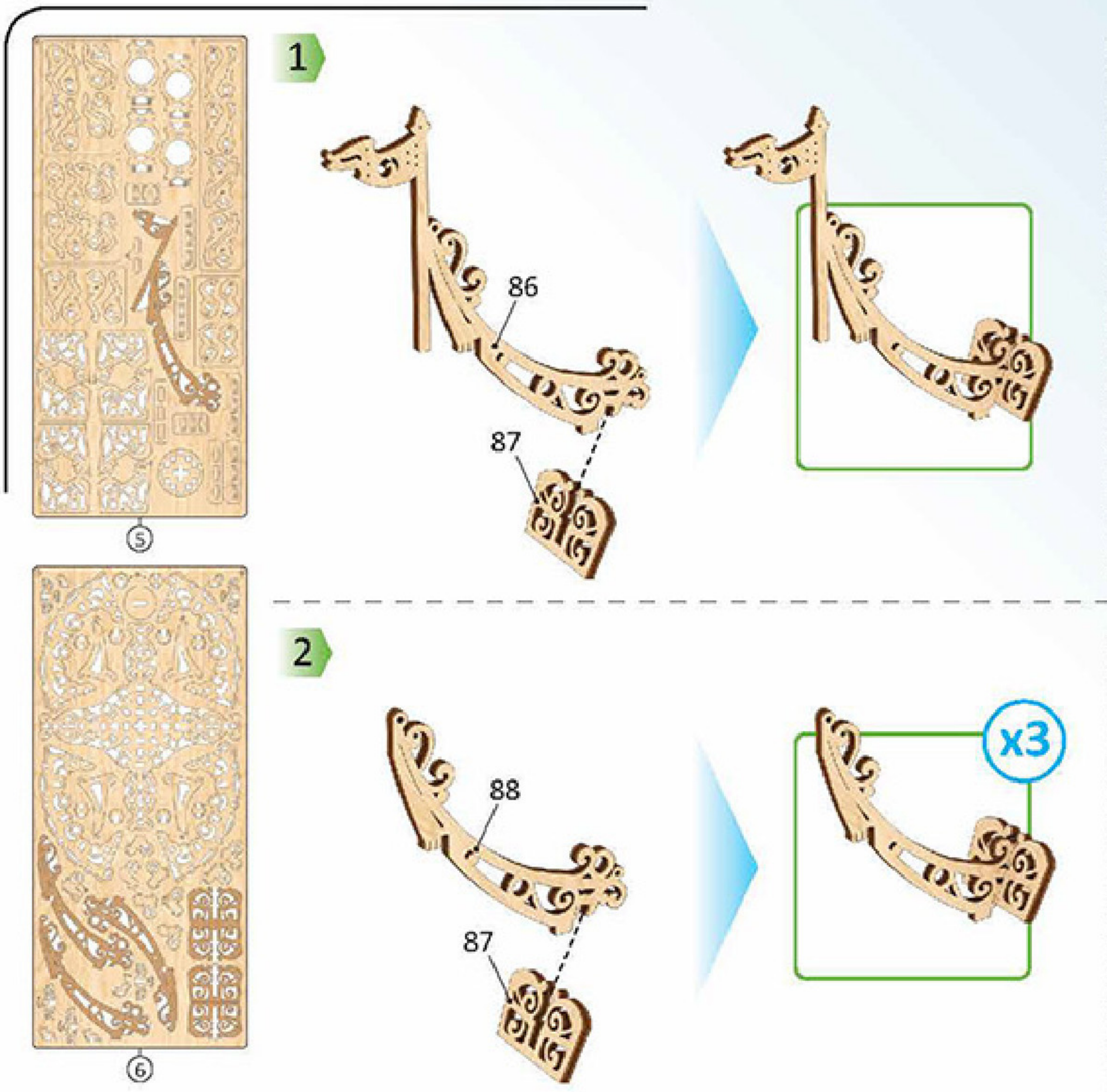



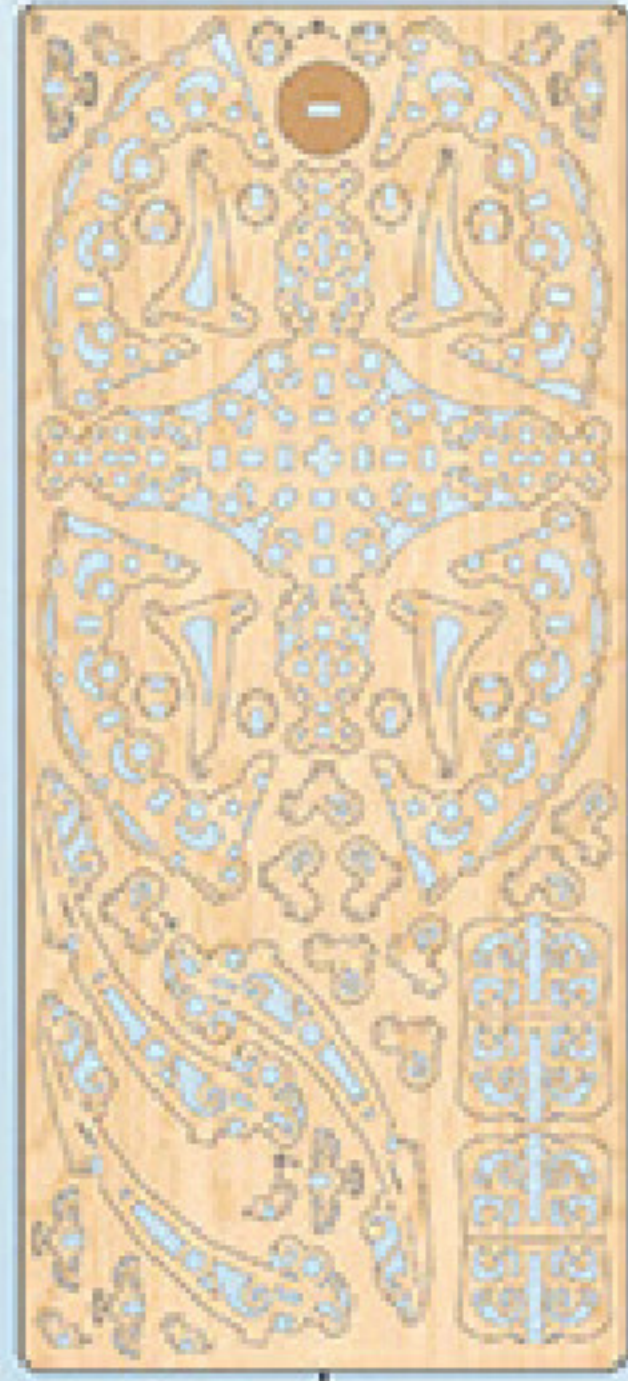

4

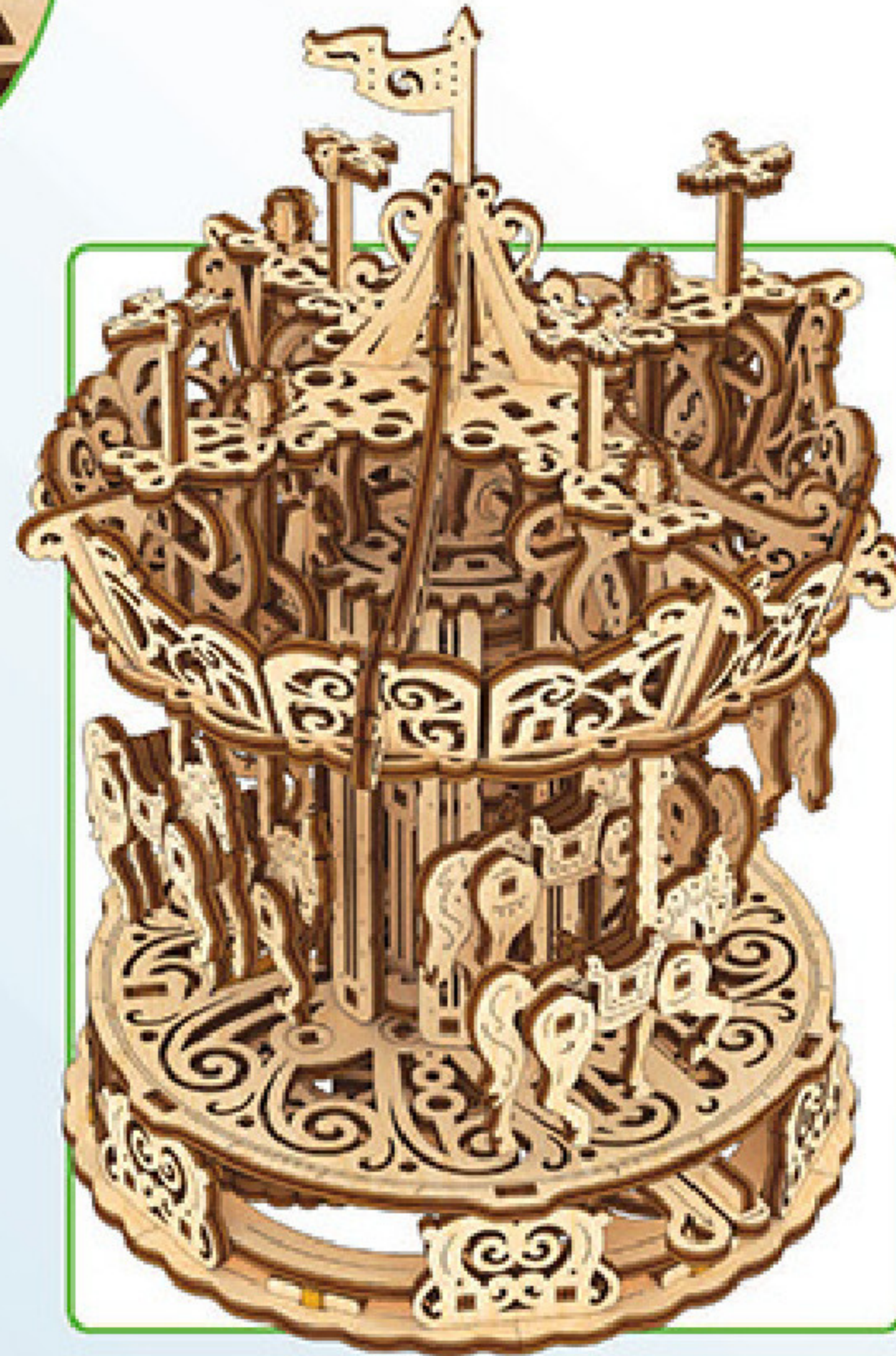
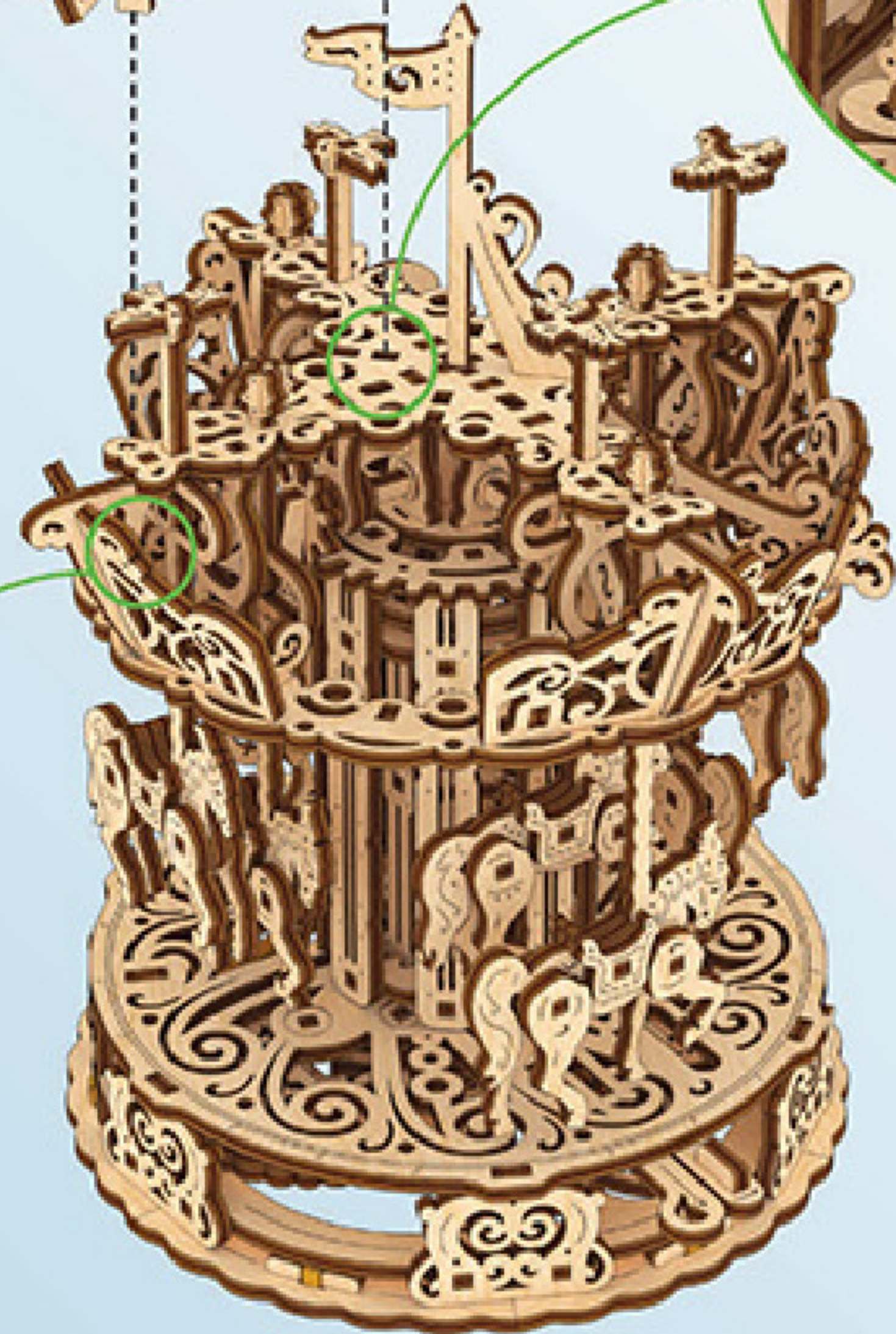
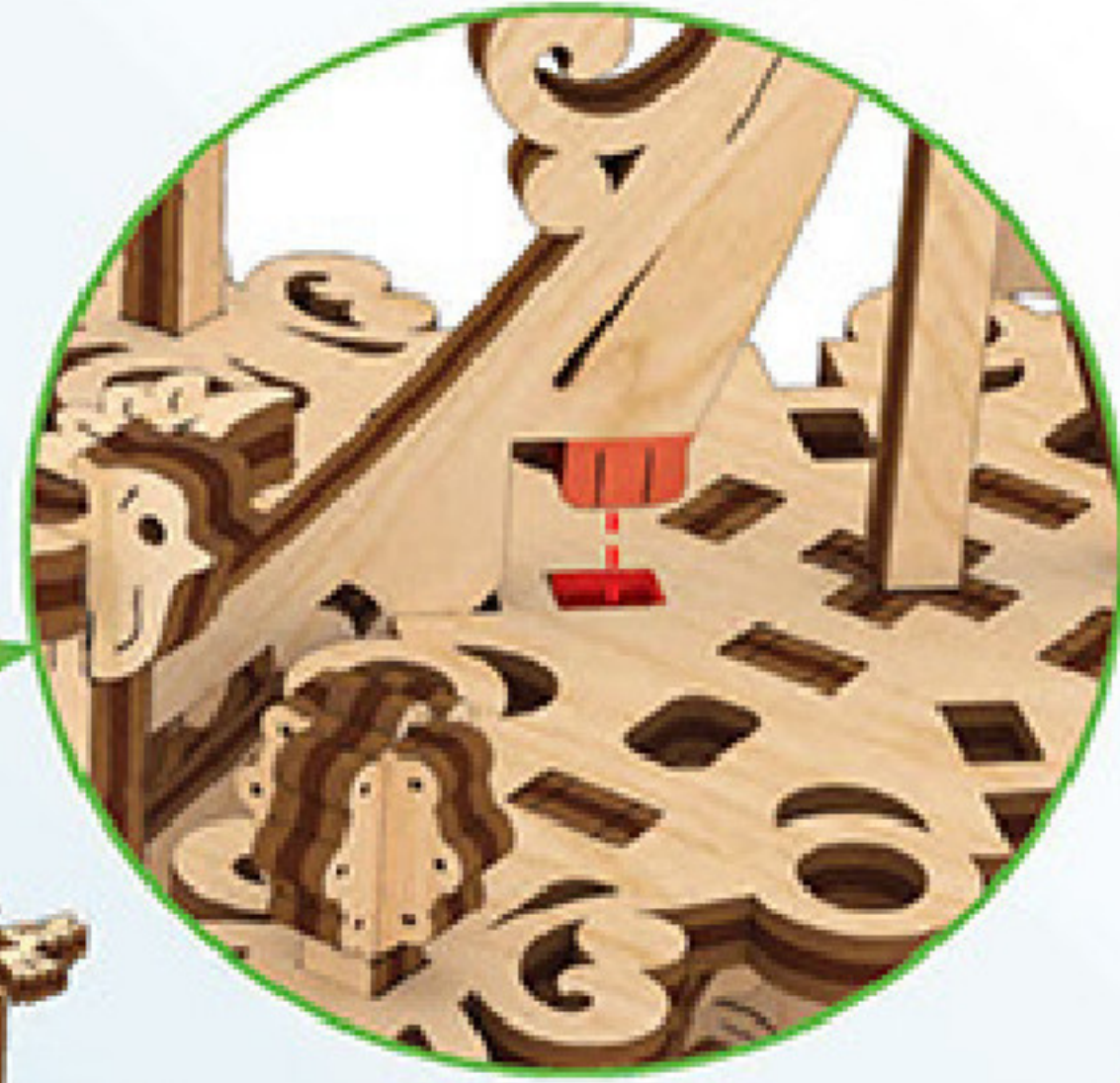
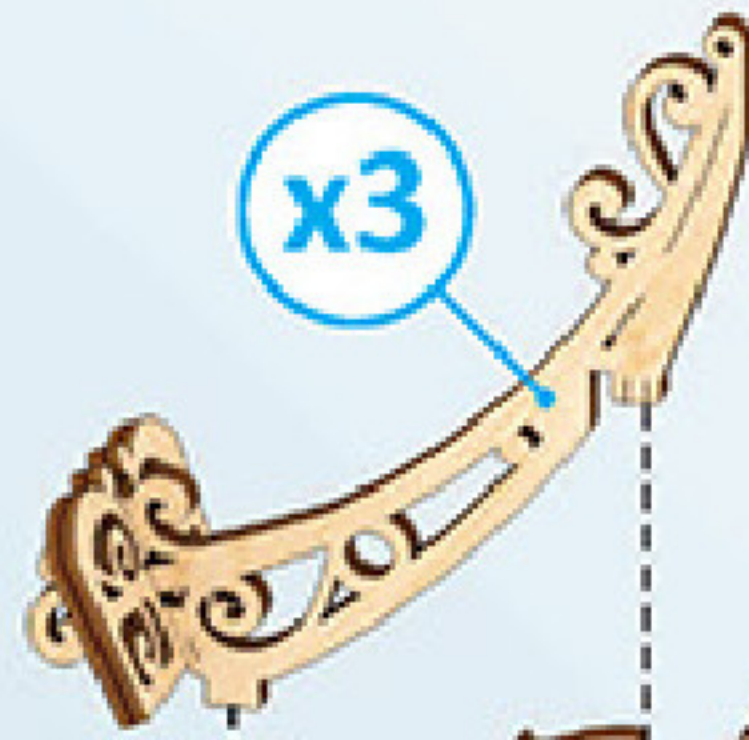

5

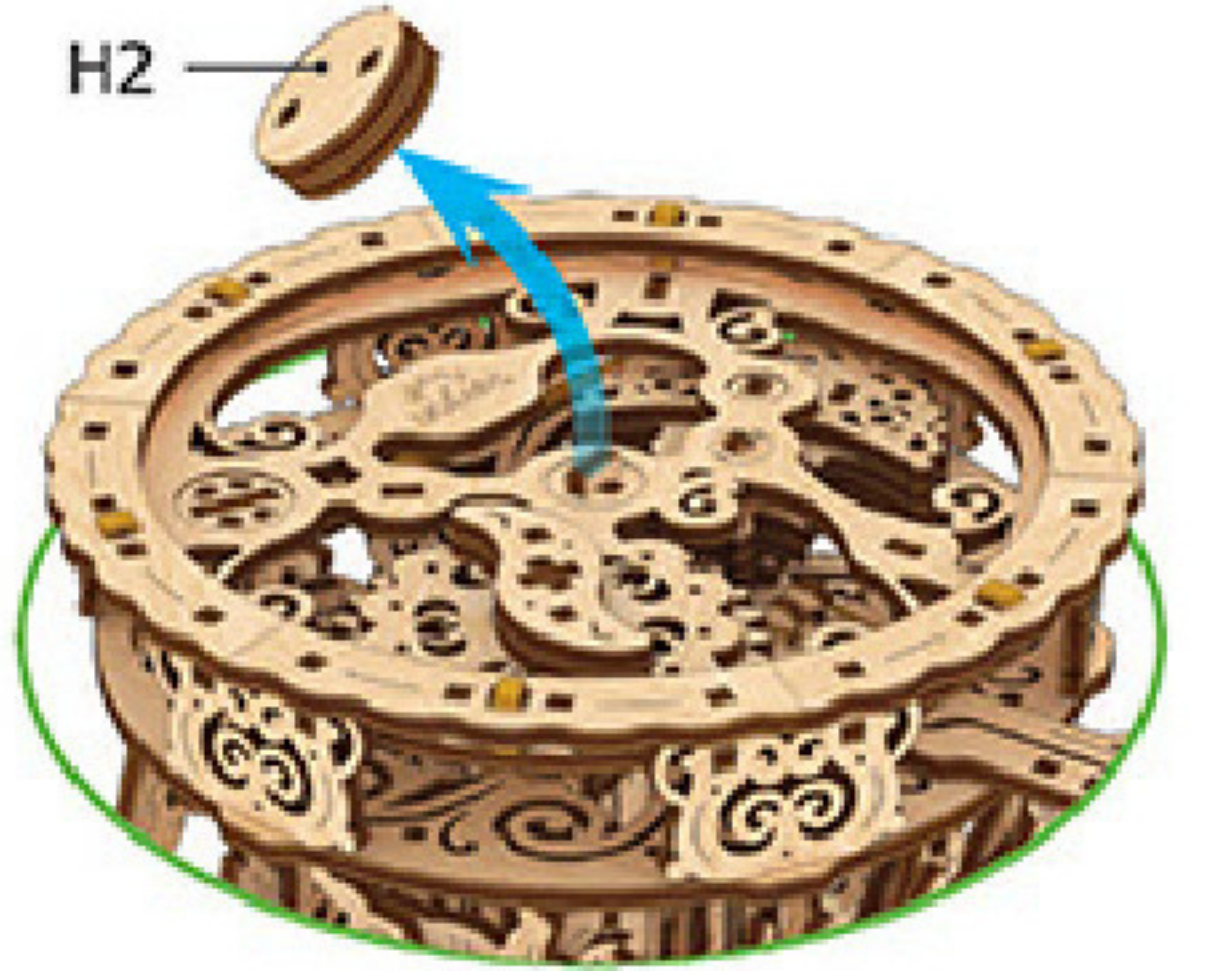

6

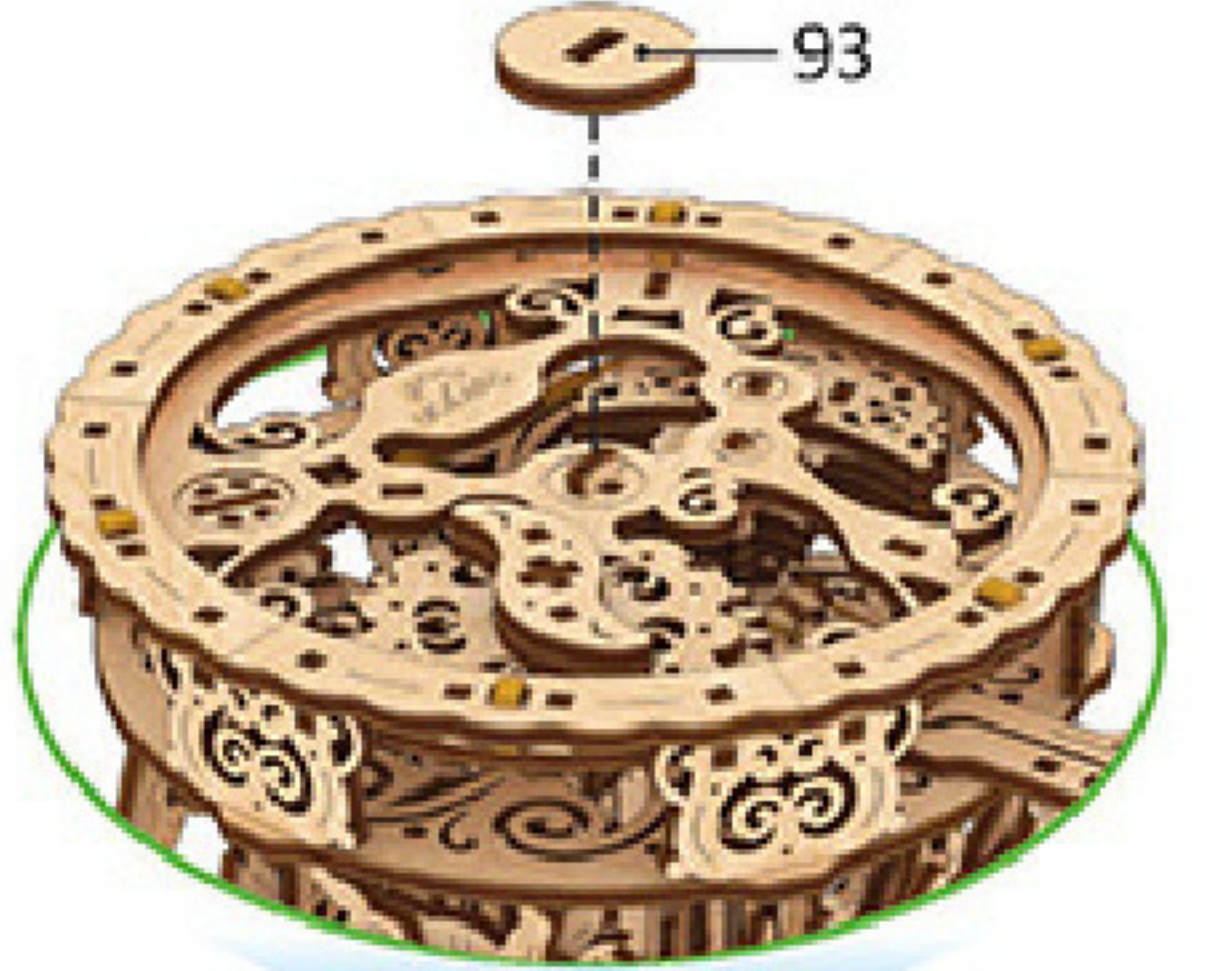



7

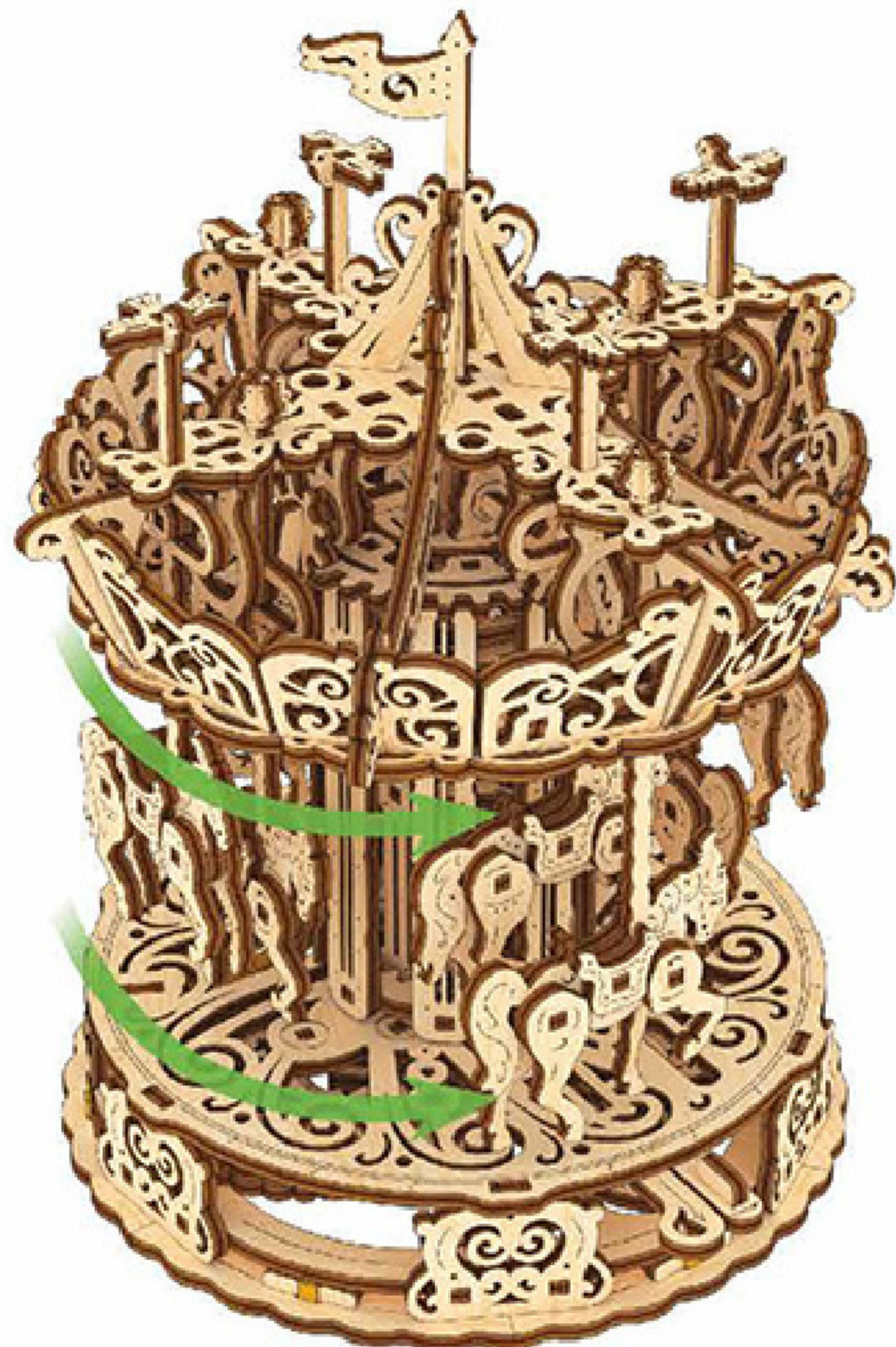
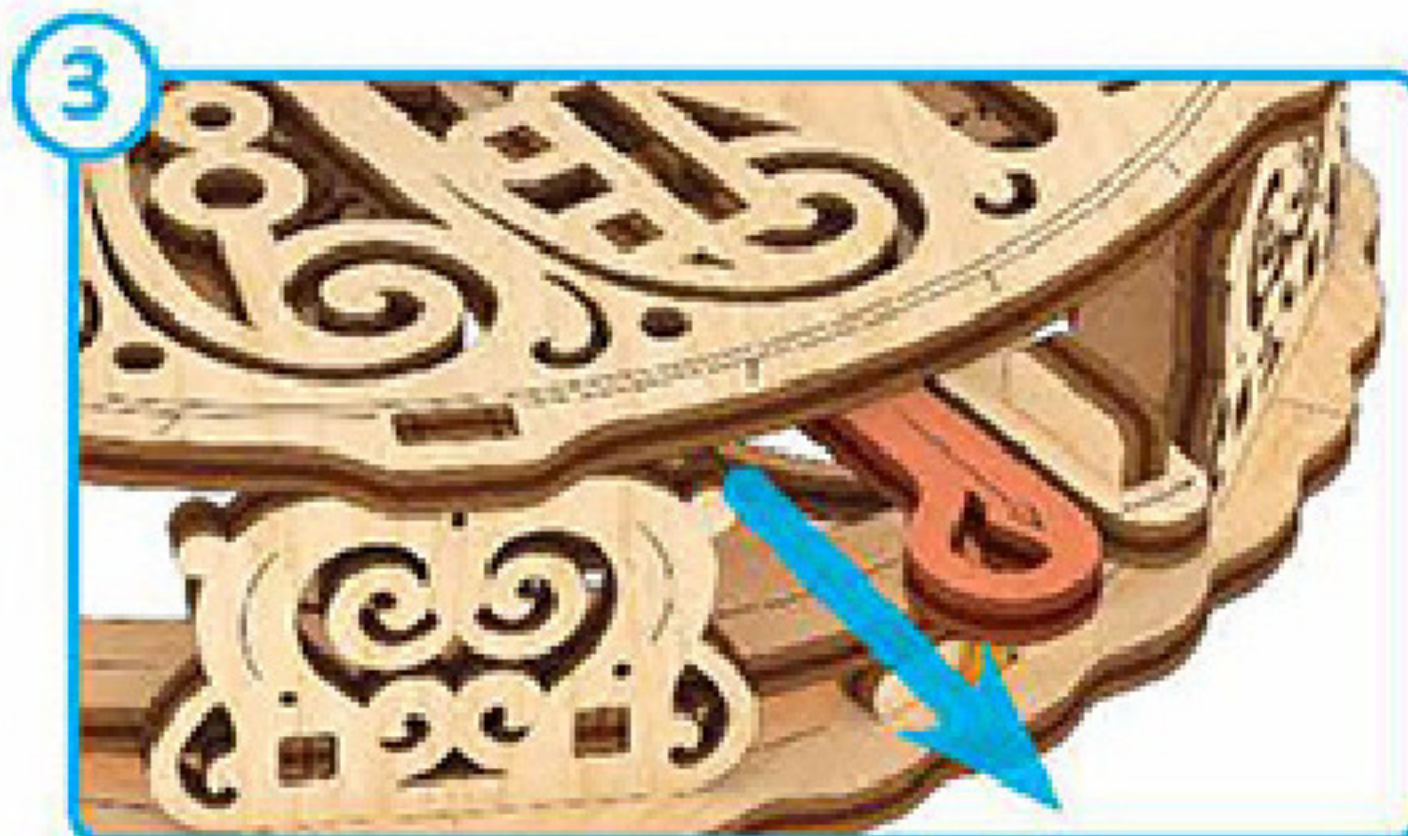
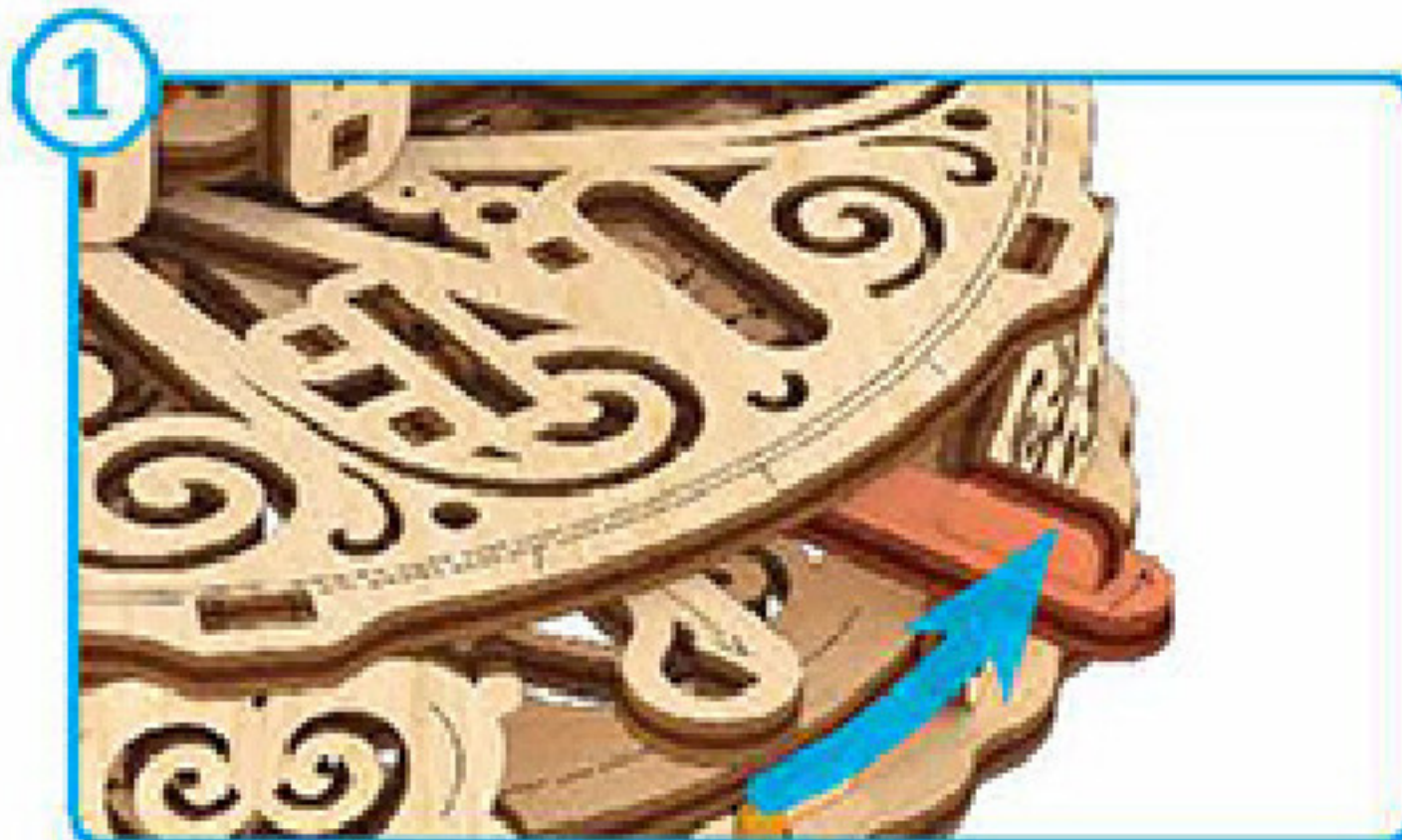





  
UGEAR<sup>®</sup>.  
Mechanical models

Bedankt voor de deelname aan  
deze reis met ons.

[ugears-shop.nl](https://ugears-shop.nl)

Klantenservice

[info@ugears-shop.nl](mailto:info@ugears-shop.nl)