

FORT KNOX BOX *Pro*

3 IN 1 - 3D PUZZLE GAME

ASSEMBLY INSTRUCTION

BUILD YOUR OWN ESCAPE ROOM

100%
BIO

ESCAPE
ROOM
2 GO

NATURAL
BIRCH
WOOD

DIY
3D
PUZZLE

EASY
ASSEMBLY

NO GLUE
NEEDED

MADE IN
GERMANY

1-2
PLAYERS

EASY
TO BUILD

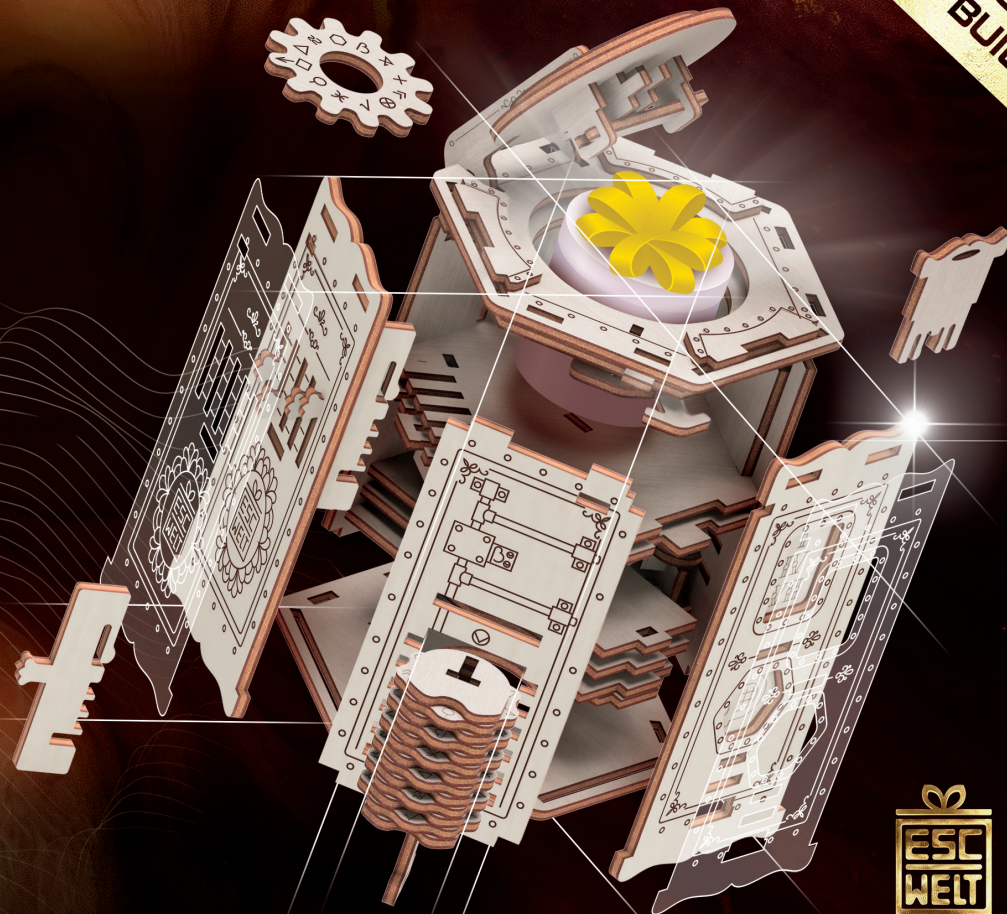
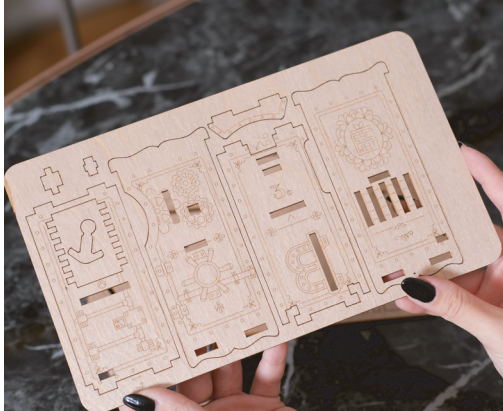

TABLE OF CONTENTS

Introduction	3
Legend	5
BUILD.	6
PLAY.	26
GIFT.	28
Check out our other games!	31

LET THE FUN BEGIN!

Thank you for choosing our product! Here you get the precise step-by-step instructions for the 3 game variations of this 3D puzzle.



1. BUILD

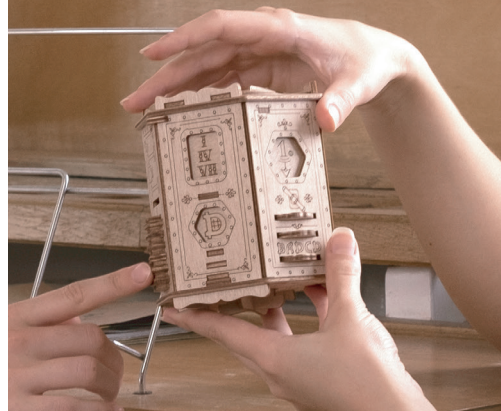

2. PLAY



3. GIFT

DE

Lasst den Spaß beginnen! Danke, dass du dich für unser Produkt entschieden hast! Hier erhältst du die genauen Schritt für Schritt Anleitung für die 3 Spielvariationen dieses 3D Puzzles.

ES

¡Que empiece la diversión! ¡Gracias por elegir nuestro producto! Aquí tienes las instrucciones precisas, paso a paso, para las 3 variantes de juego de este rompecabezas en 3D.

FR

Que le plaisir commence! Merci d'avoir choisi notre produit! Voici les instructions précises, étape par étape, pour les 3 jeux différents de ce puzzle en 3D.

JP

さっそくお楽しみください! この度は弊社製品をお買い上げいただきありがとうございます。本ガイドでは、3Dパズルの3種類のゲームに関する、ステップバイステップの詳しい組み立て方法をご紹介します。

ASSEMBLY INSTRUCTION

Carefully remove the parts from the wooden board as shown on the drawing. Be cautious, try not to break any parts. If you are unable to remove them, cut the connections with a knife. The puzzle is assembled without application of glue.

To avoid difficulties with the installation of the wooden axis, wax the details with a regular candle before the installation and during the assembly process. This will improve the sliding of the parts in the future.



DE

Anleitung zum Zusammenbau: Entferne die Teile vorsichtig von der Holzplatte, wie in der Zeichnung gezeigt. Bitte achte darauf, dass du keine Teile abbrichst. Gelingt es dir nicht, die Teile ganz zu entfernen, schneide die Verbindungen mit einem Messer durch.

Beim Zusammenbau des Puzzles wurde kein Leim verwendet. Damit es beim Einbau der Holzachse nicht zu Schwierigkeiten kommt, solltest du die Teile vor dem Einbau und während des Zusammenbaus mit einer normalen Kerze wachsen. Auf diese Weise lassen sich die Teile in Zukunft besser verschieben.

FR

Instructions de montage: Retirez avec précaution les pièces de la planche de bois comme indiqué sur le dessin. Soyez prudent, tâchez de ne pas casser de pièces. Si vous ne parvenez pas à les retirer, coupez les connexions avec un couteau. Le puzzle est assemblé sans application de colle.

Afin d'éviter des difficultés lors de l'installation de l'axe en bois, il est conseillé de cirer les éléments avec une bougie ordinaire avant l'installation et pendant le processus de montage. Cela permettra d'améliorer le glissement des pièces pour l'utilisation à l'avenir.

ES

Instrucciones de montaje: Retira cuidadosamente las piezas del tablero de madera como se muestra en el dibujo. Ten cuidado, intenta no romper ninguna pieza. Si no puedes retirarlas, corta las uniones con un cuchillo. El rompecabezas se monta sin necesidad de aplicar cola.

Para evitar complicaciones en la instalación del eje de madera, encera las piezas pequeñas con una vela corriente antes de instalarlas y durante el proceso de montaje. Esto hará que las piezas se deslicen mejor en el futuro.

JP

組み立ての手順

図のように、木製のボードから慎重にパーツを取り外してください。部品を壊さないようご注意ください。どうしても外せない場合は、接続部分をナイフなどでカットしてください。このパズルは、接着剤を使わずに組み立てられています。

木製の軸となる部品の取り付けを容易にするために、取り付け前と組み立て中に一般的なろうそくを使い、細部にろうを塗ってください。こうすることで、部品のすべりが良くなります。



WARNING!

Avoid Open Flame!

DE

Vermeiden Sie offenes Feuer!

ES

¡Evitar las llamas vivas!

FR

Évitez toute sorte de flamme à proximité!

JP

直火を避ける!

LEGEND

DE Legende. ES Leyenda. FR Légende. JP 凡例



WAX THE DETAIL WITH A COMMON CANDLE.

DE Wachsen Sie das Detail mit einer normalen Kerze.
ES Encera las piezas con una vela convencional.
FR Cirez les détails avec une bougie ordinaire.
JP 一般的なろうそくで細部をワックスします。



REMOVE SPLINTERS USING SANDPAPER.

DE Entfernen Sie die Splinter mit Schleifpapier.
ES Elimina las astillas con papel de lija.
FR Enlever les échardes à l'aide d'un papier de verre.
JP サンドペーパーで破片を取り除きます。



CHECK THE CORRECT POSITION OF THE ELEMENT.

DE Überprüfen Sie die korrekte Position des Elements.
ES Comprueba la ubicación correcta del elemento.
FR Vérifier la bonne position de l'élément.
JP エレメントの正しい位置をチェックしてください。



CHECK THE MECHANISM FOR SMOOTHNESS.

DE Prüfen Sie den Mechanismus auf Geschmeidigkeit.
ES Revisa el mecanismo para que funcione con suavidad.
FR Vérifier la régularité du mécanisme.
JP 機構の滑らかさをチェック。

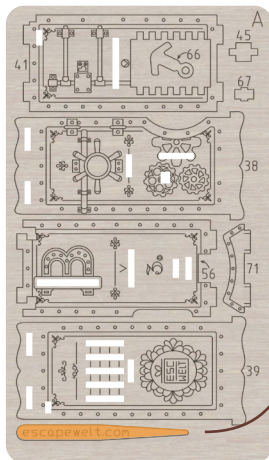

AUXILIARY TOOL

Note that this is not an assembly item, but an assembly tool.
You may use it to squeeze out the elements.

DE

Hilfswerkzeug: Beachten Sie, dass es sich hierbei nicht um ein Bauelement, sondern um ein Montagewerkzeug handelt. Sie können es verwenden, um die Elemente herauszudrücken.

ES

Herramienta auxiliar: Ten en cuenta que no se trata de una pieza sino de una herramienta de montaje. Puedes utilizarla para extraer los elementos secreto!

FR

Outil auxiliaire: Notez qu'il ne s'agit pas d'une pièce de montage, mais d'un outil de montage. Vous pouvez l'utiliser pour extraire les éléments.

JP

補助ツール: 組み立て品ではなく、組み立て工具ですのでご注意ください。これを使用し要素を絞り出すことができます。

SPARE PARTS

DE Ersatzteile. ES Piezas sueltas. FR Pièces de rechange. JP スペアパーツ。



N° 14



N° 12



N° 7



N° 4



N° 45



N° 67

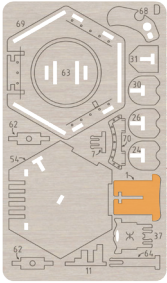

D

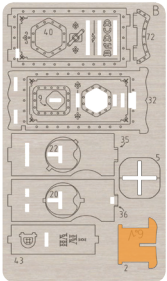

B

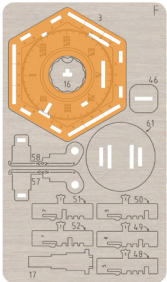

F

1

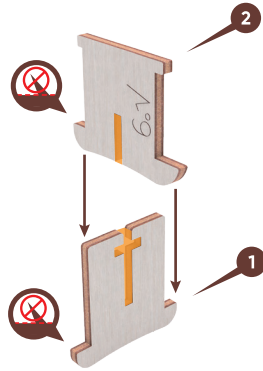

2

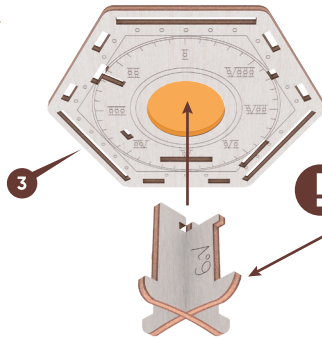

! STEP 1 ROTATES 360° INSIDE THE HOLE

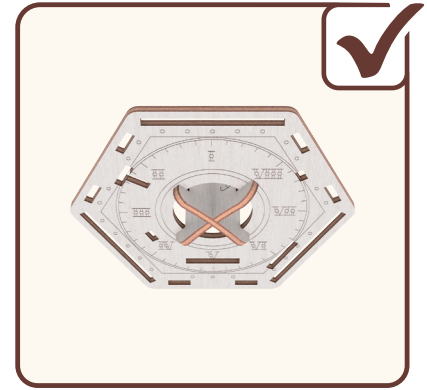
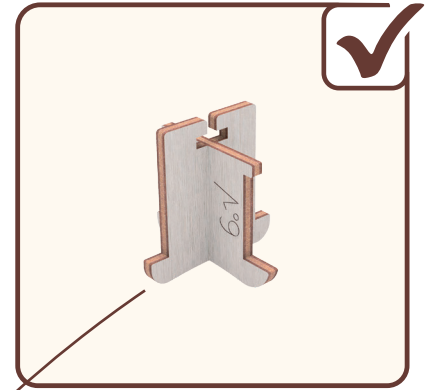

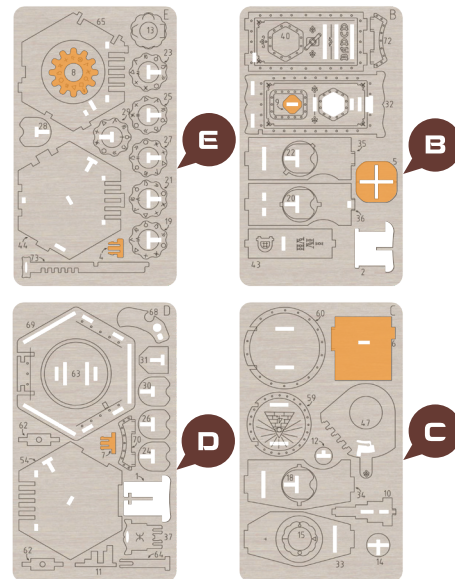
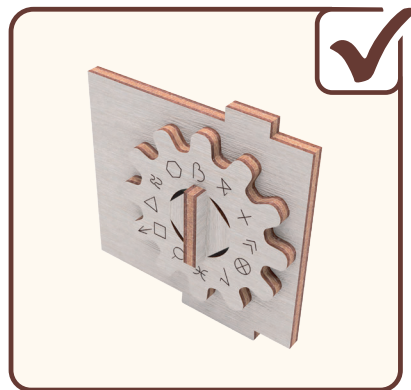
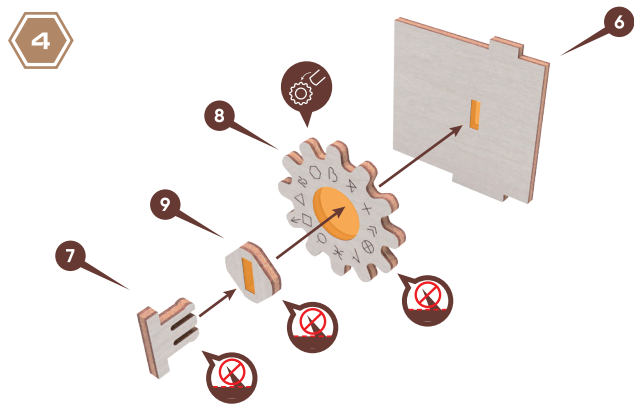
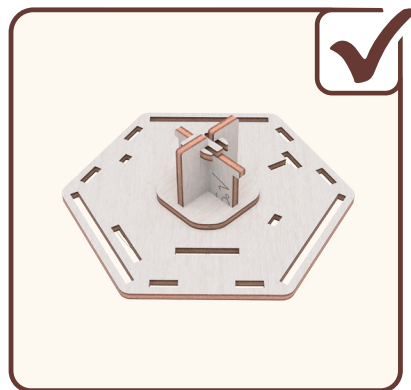
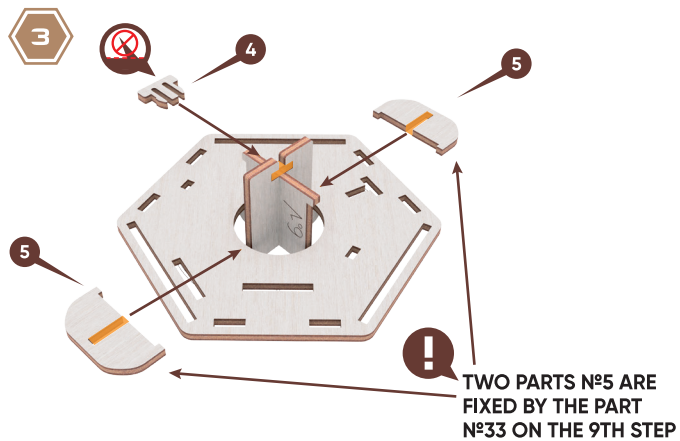

BUILD

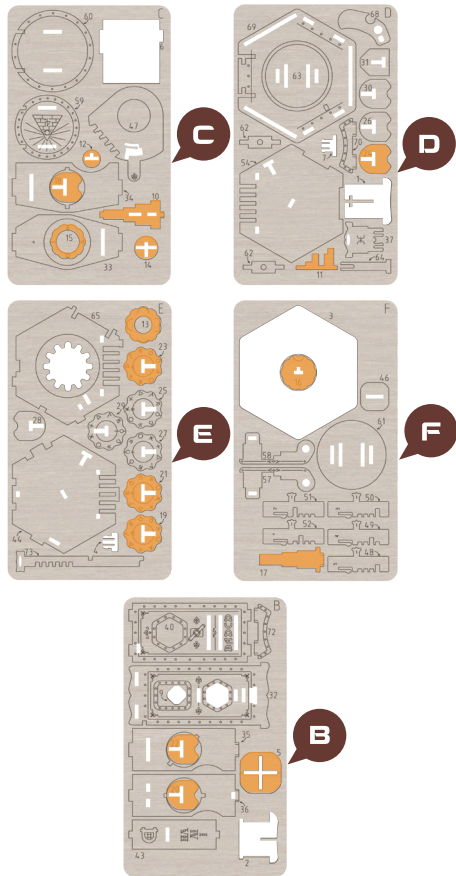

5

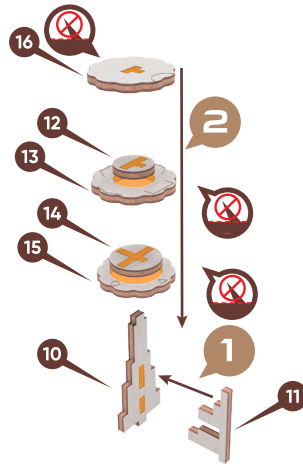

6

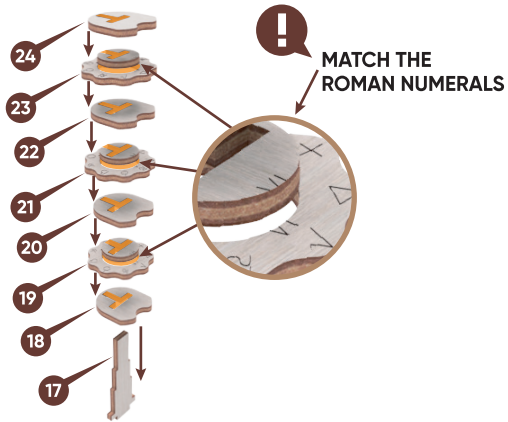

8

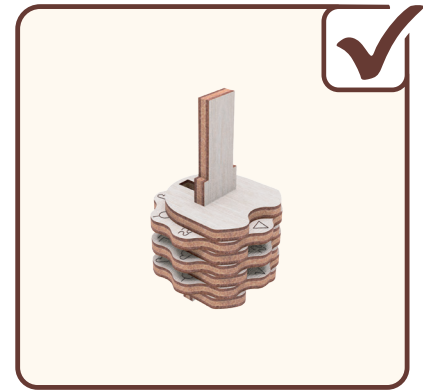
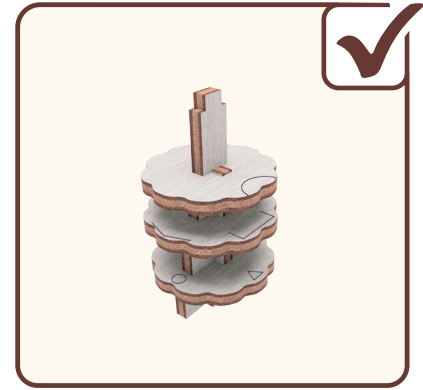

7

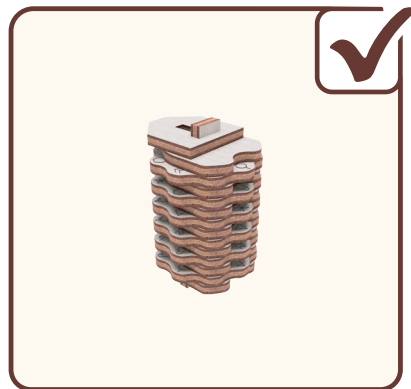
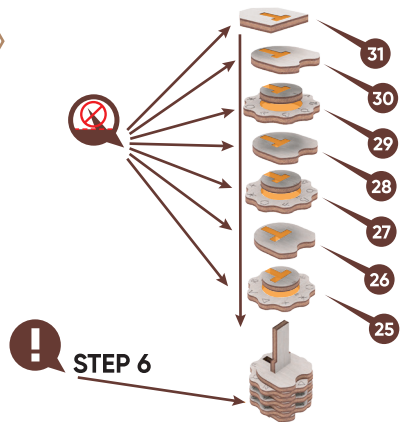

8

! STEP 3

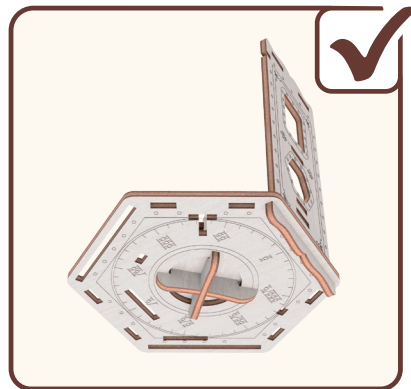
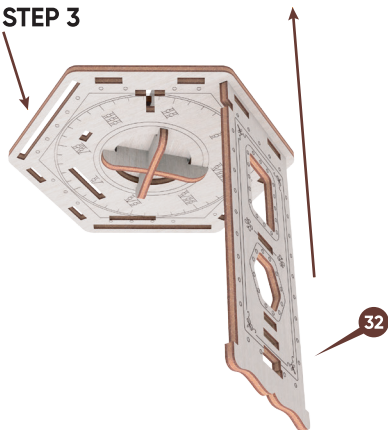

9

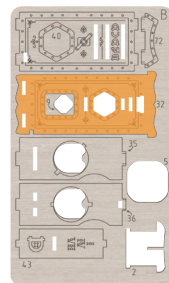
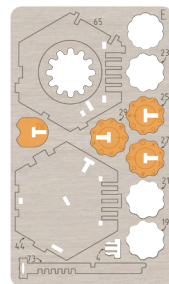
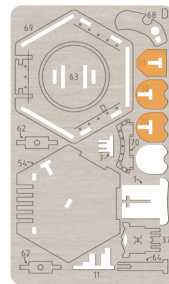

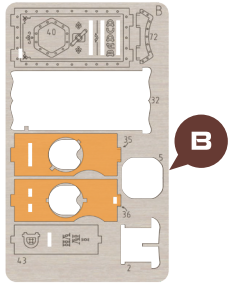
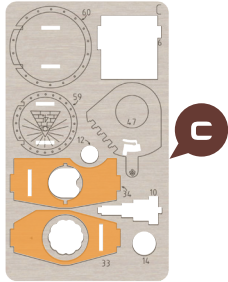

9

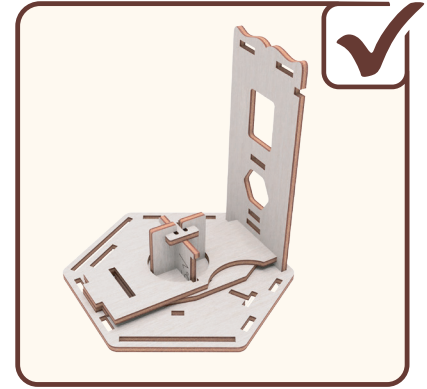
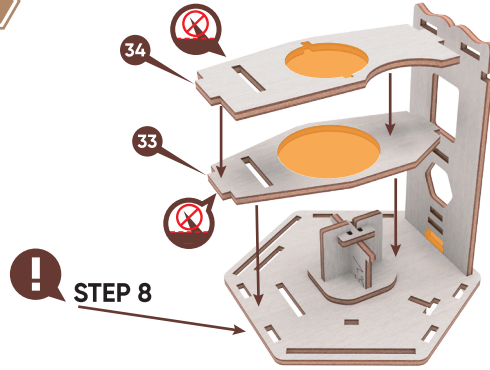

10

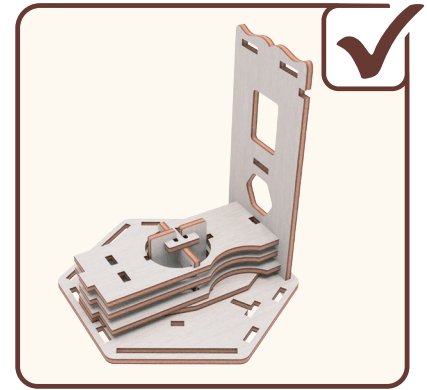
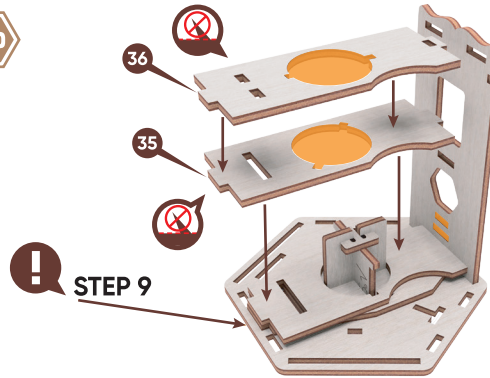

11

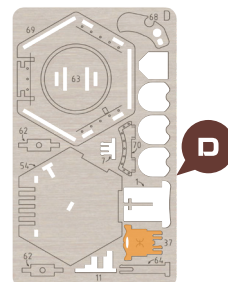
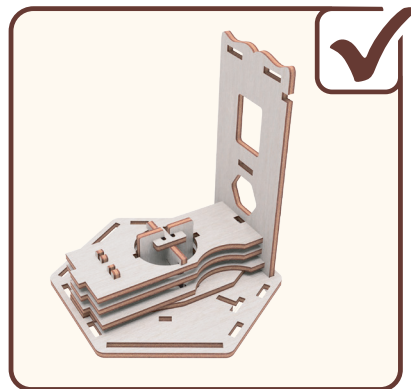
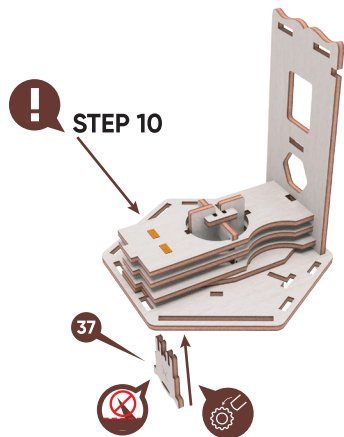

12

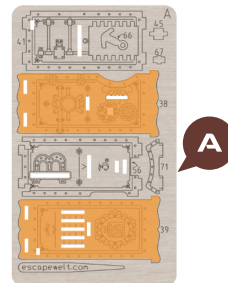
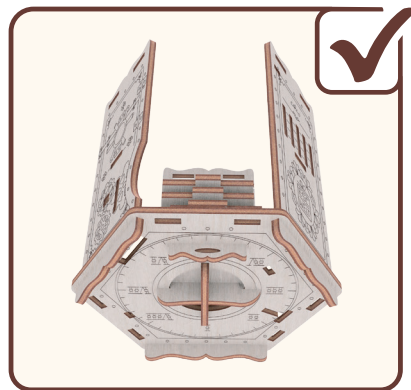
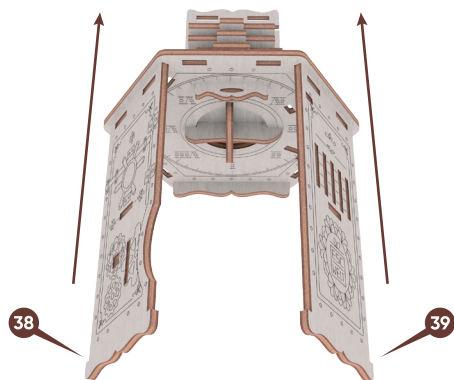

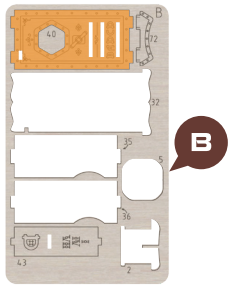

13

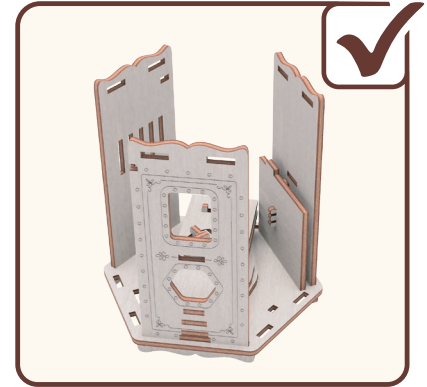
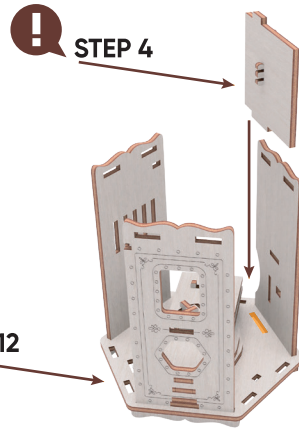

14

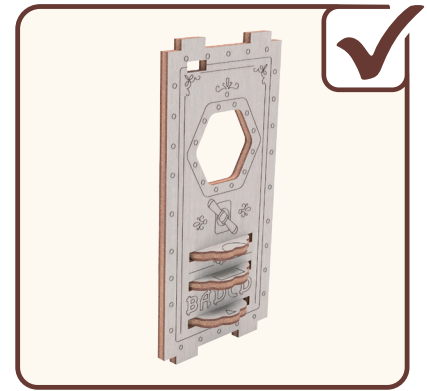
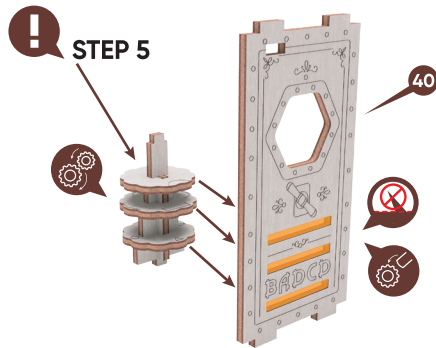

15

! STEP 14



! STEP 13

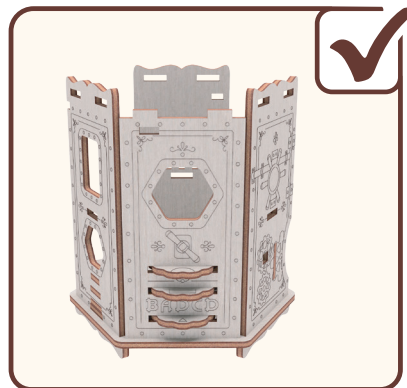

16

! STEP 7

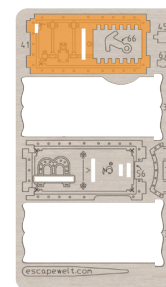
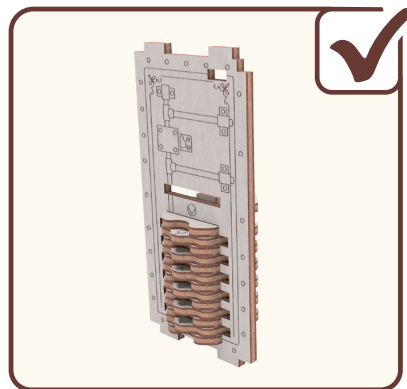
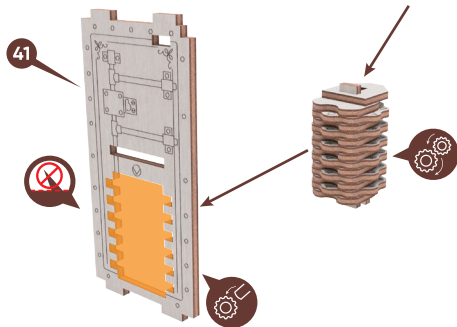

A

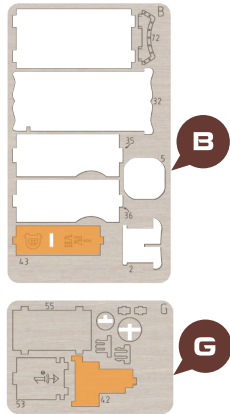

17

! STEP 16

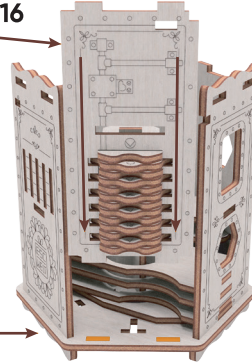

! STEP 15

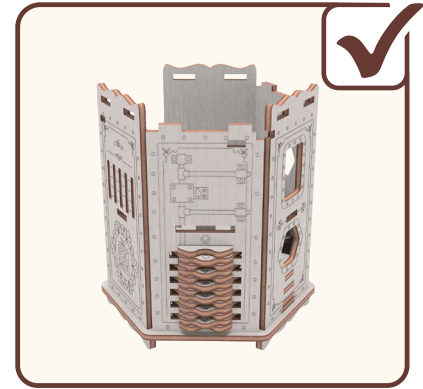

18

43 42

! STEP 15

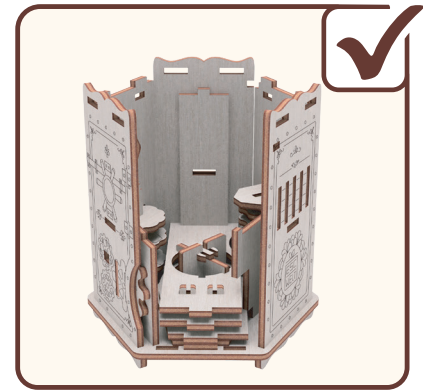
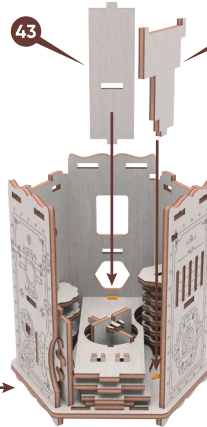

19

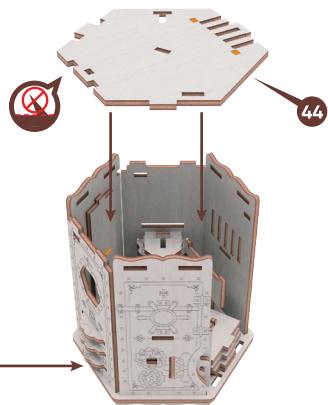

! STEP 18

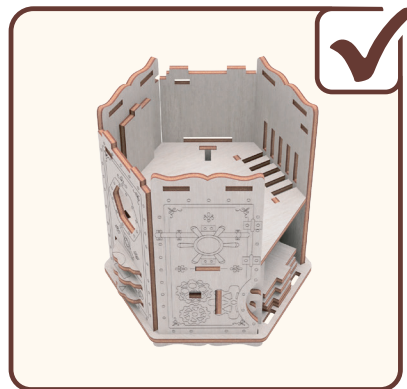

20

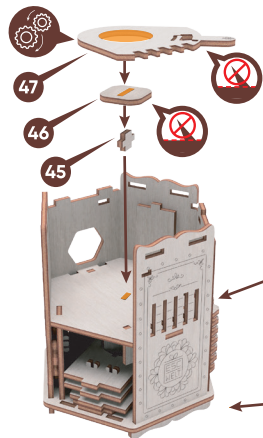

! INSERT THE SLIDER INTO THE HOLE

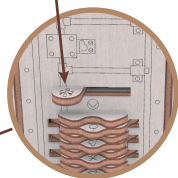

! STEP 19

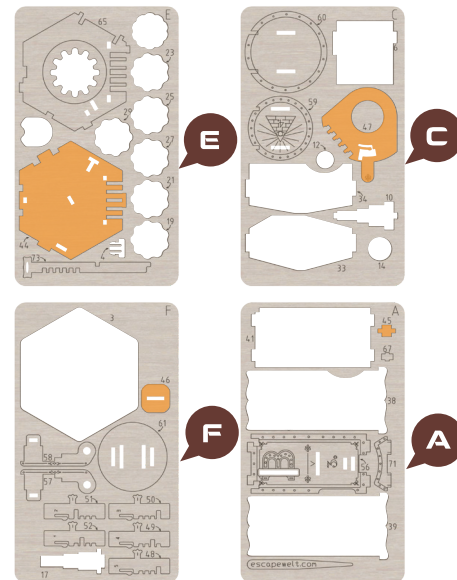
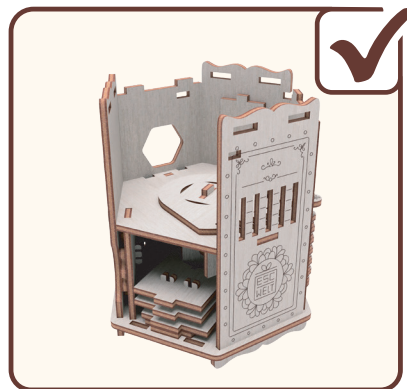

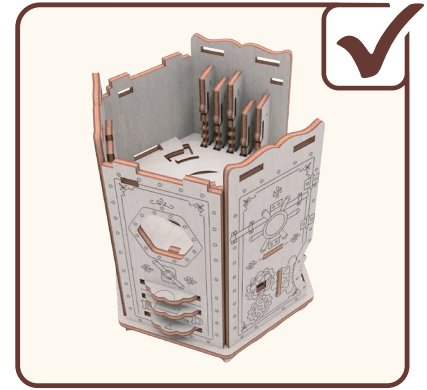
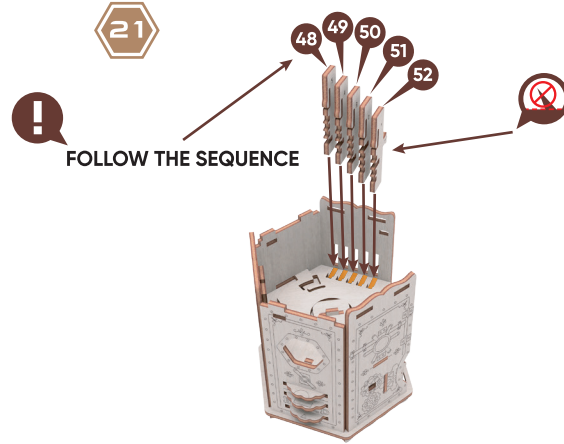
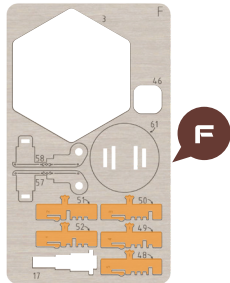

22

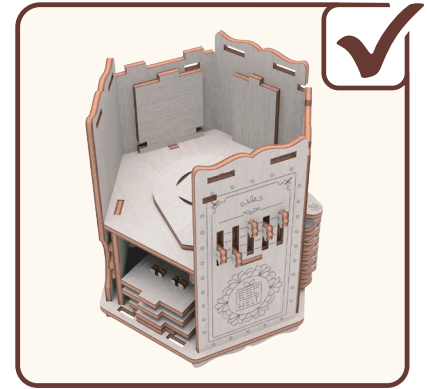

23

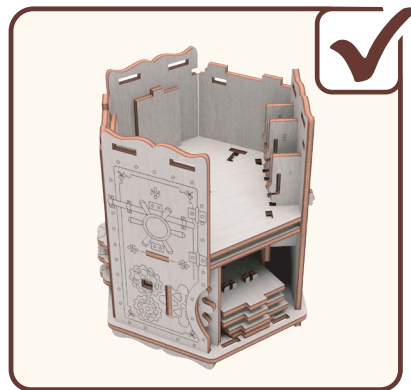
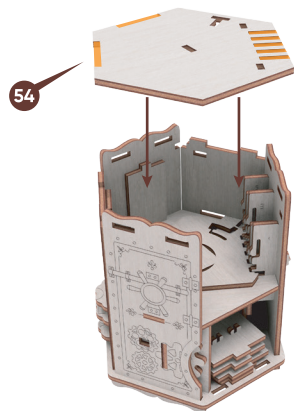

24

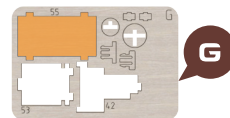
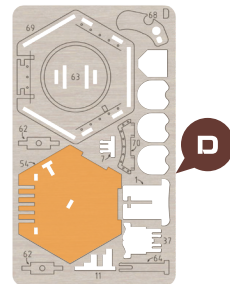
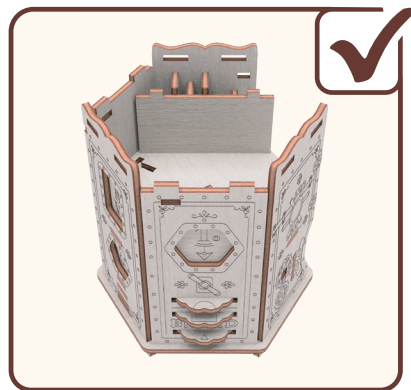

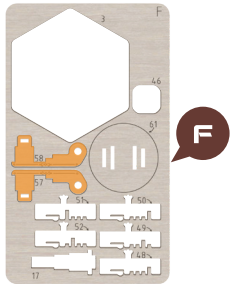
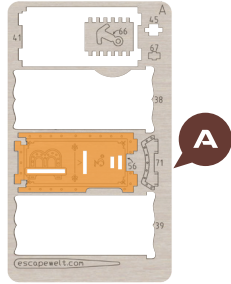

25

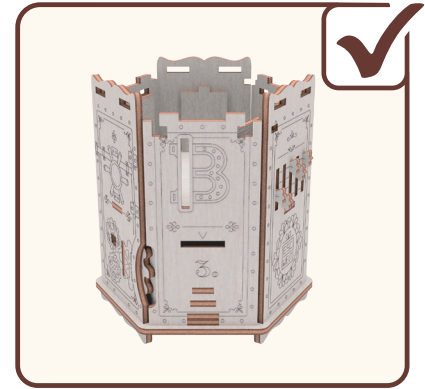

26

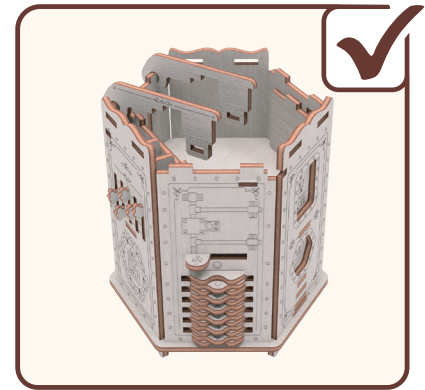
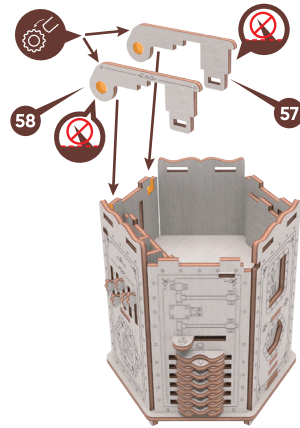

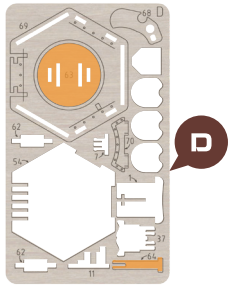

29

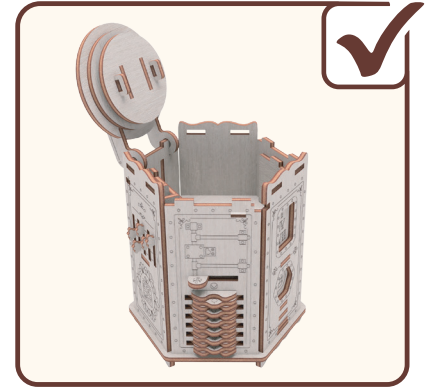
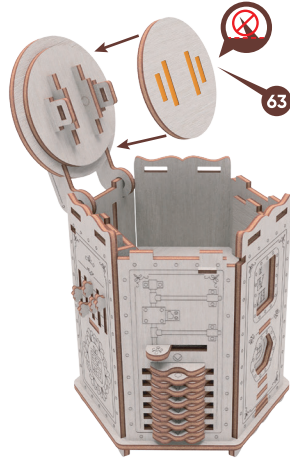

30

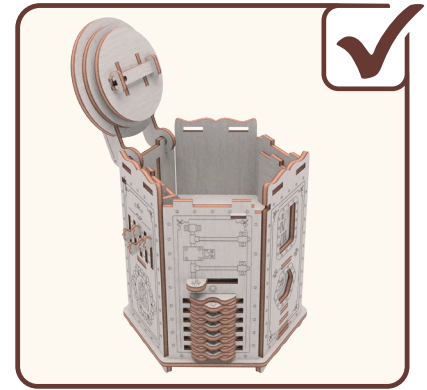
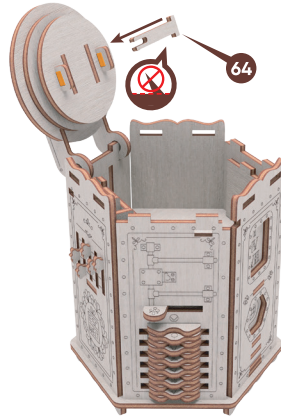

31

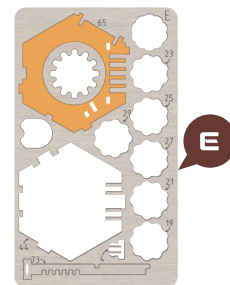
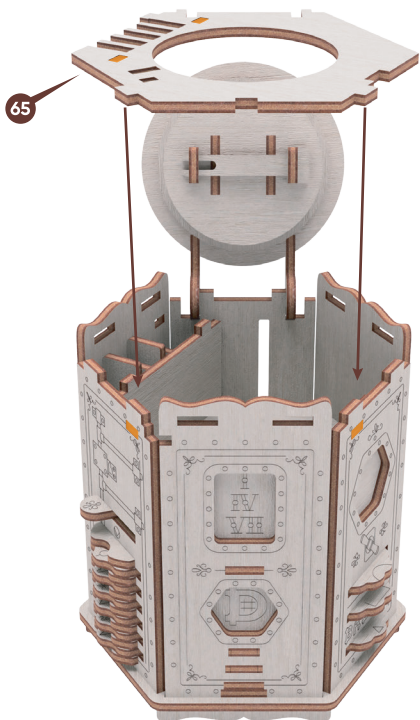

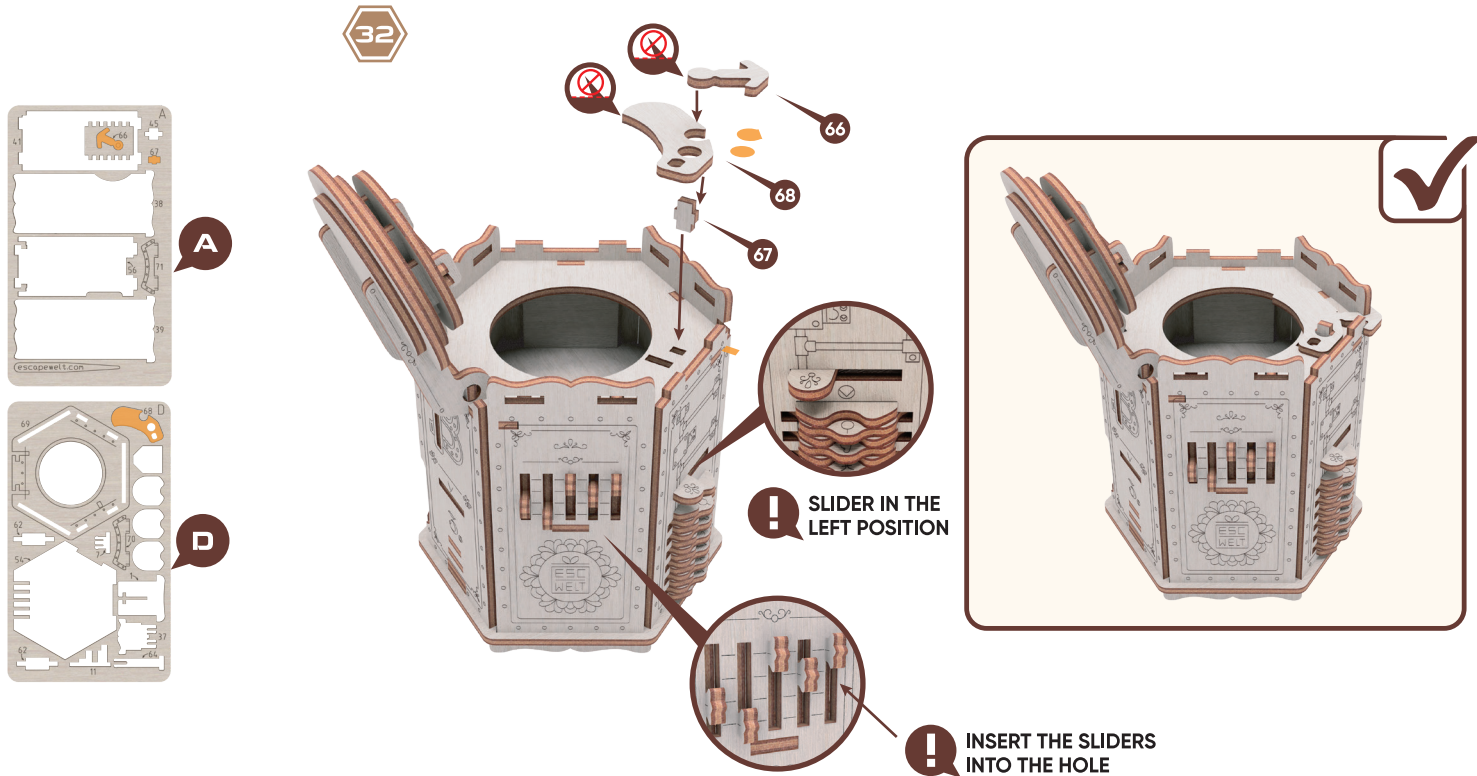

33

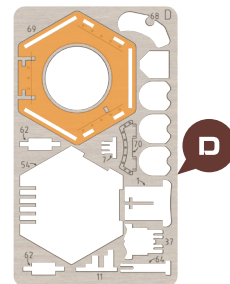



34



! MOVE THE SLIDER TO ANOTHER POSITION

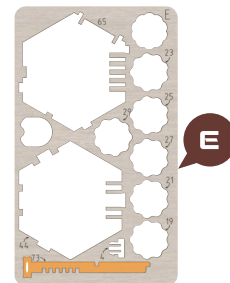
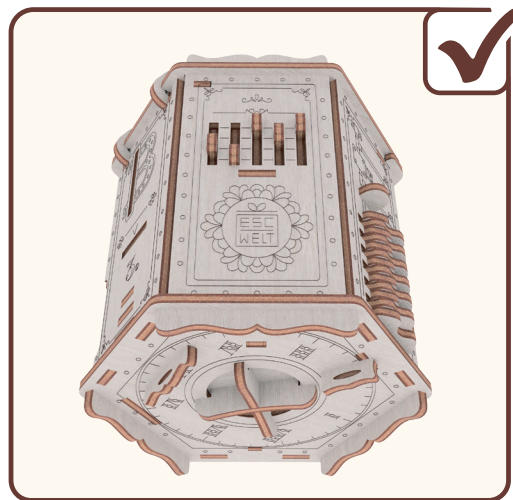
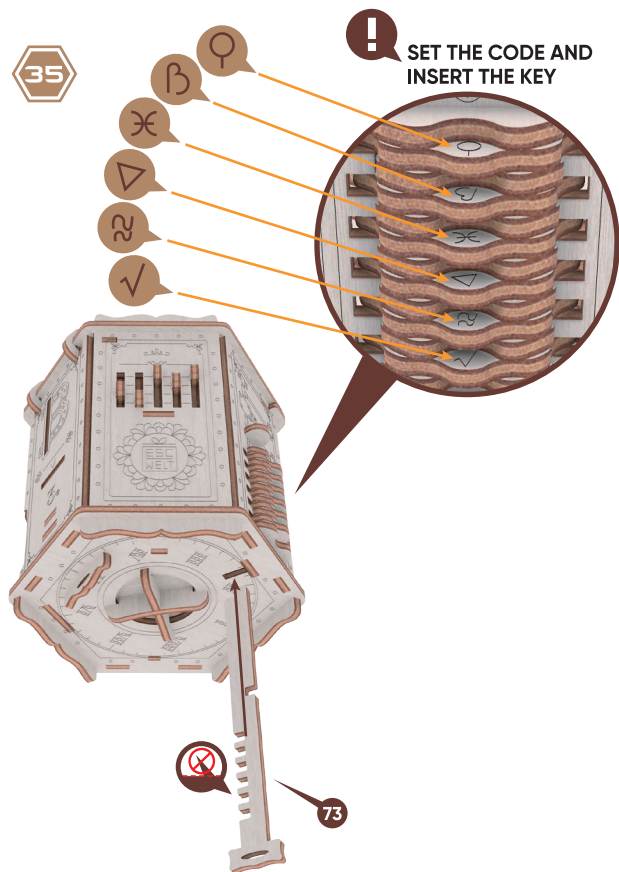

YOUR ESCAPE ROOM IS READY FOR GAME!

Go on an exciting adventure with your friends!



DE

Dein Escape Room ist bereit zum Spielen! Begib dich auf ein spannendes Abenteuer mit deinen Freunden!

ES

¡Tu sala de escape está lista para jugar! ¡Embárcate en una emocionante aventura con tus amigos!

FR

Votre salle d'évasion est prête pour le jeu! Partez pour une aventure passionnante avec vos amis!

JP

クエストルームで遊ぶ準備が整いました！友だちと一緒にワクワクする冒険に出かけよう！

NEED HELP?

If you have any difficulties, or you don't have enough free time, then scan the QR-code to get a hint and a solution.



DE

Benötigst du Hilfe? Bei Schwierigkeiten oder wenn du nicht genug Zeit hast, scanne den QR-Code, um einen Hinweis oder die Lösung zu erhalten.

ES

¿Necesitas ayuda? Si tienes alguna dificultad o no tienes suficiente tiempo libre, escanea el código QR para conseguir una pista y una solución.

FR

Besoin d'aide? Si vous avez des difficultés, ou si vous n'avez pas assez de temps libre, scannez le code QR pour obtenir un indice et une solution.

JP

助けが必要ですか?
QRコードをスキャンして、ヒントと解決策をご確認いただけます。



SCAN ME FOR TIPS

OPEN THE HIDDEN CHAMBER



DE

Öffne die
verborgene
Kammer!

ES

¡Abre la cámara
secreta!

FR

Ouvrir la chambre
cachée!

JP

隠された部屋
を開けよう!

HIDE YOUR GIFT



DE

Verstecke dein
Geschenk

ES

Esconde tu regalo

FR

Ouvrir la chambre
cachée

JP

プレゼントを
隠そう

GIFT

LET YOUR LOVED ONES SOLVE ALL THE PUZZLES

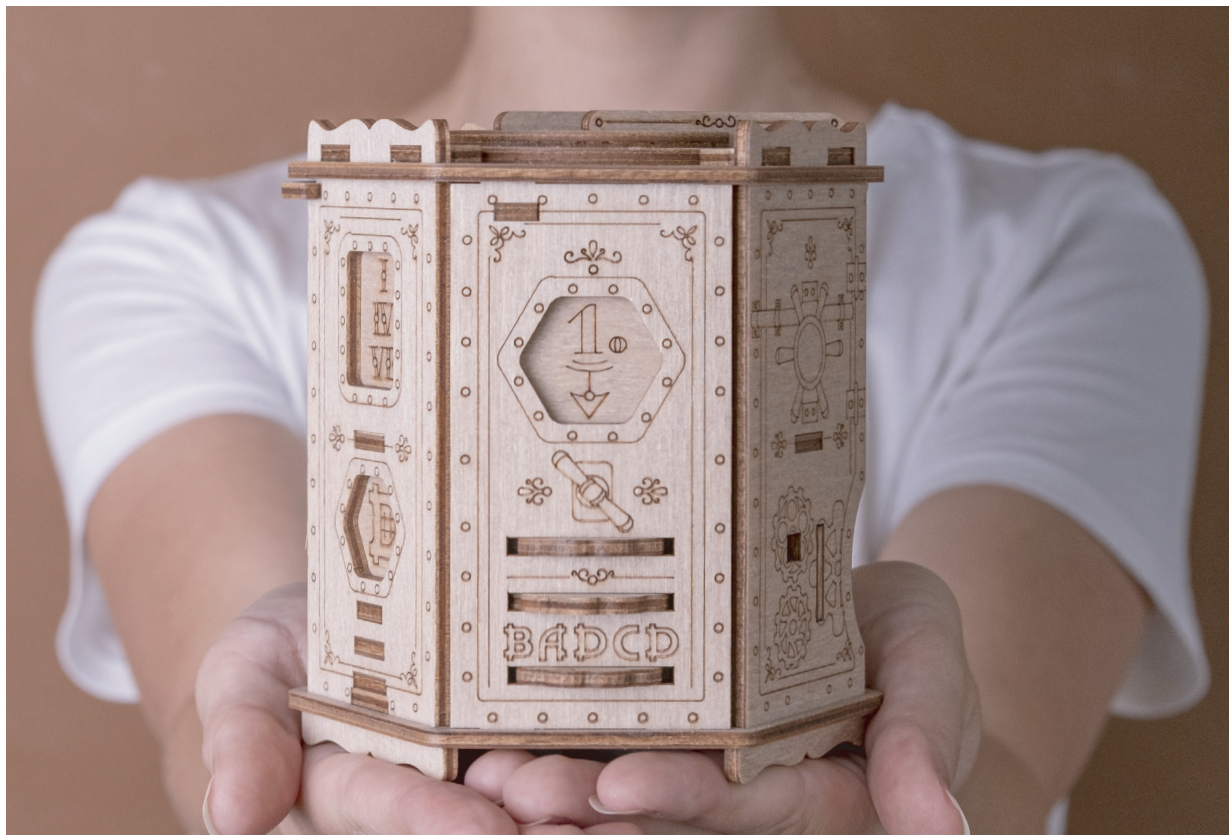

DE

Lass deine Liebsten alle
Rätsel lösen

ES

Deja que tus seres queridos
resuelvan todos los
rompecabezas

FR

Laissez vos proches résoudre
toutes les énigmes

JP

好きな人にすべてのパ
ズルを解いてもらいま
しょう

CHECK OUT OUR OTHER GAMES!

DE Entdecke auch unsere anderen Spiele! ES Descubre nuestros otros juegos! FR Regardez nos autres jeux! JP 弊社のその他のゲームもご覧ください!

ESCAPE ROOM IN A BOX & PUZZLES



QUEST PYRAMID

Unravel the secrets of Ancient Egypt

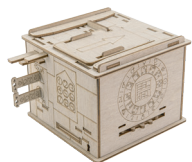

SPACE BOX

Breathtaking Space Odyssey in the comfort of your own home



FORT KNOX

Open the box and complete your secret mission!



ORBITAL BOX

Challenge your brain to find a way out



HOUSE OF THE DRAGON

For all fans of Japanese history



FORT KNOX BOX PRO

New version of a legendary toy



QUEST PUZZLE

Try to solve it in 60 minutes!

3 IN 1 — 3D PUZZLES GAMES



LABYRINTH PUZZLE

It's actually harder than it seems



QUEST PYRAMID



SPACE BOX



ORBITAL BOX



SCAN ME AND GET MORE OF OUR TOYS AND PUZZLES

LET'S STAY IN TOUCH!

Learn more about EscapeWelt



[ESCAPEWELT.COM](https://www.escapewelt.com)

Do you prefer shopping on Amazon?



[VISIT US](#)

Join us on social platforms, stay up to date with the news and participate in giveaways



[@escapewelt](https://www.instagram.com/escapewelt)



[@EscapeWelt](https://www.facebook.com/EscapeWelt)



t.me/escapeweltquiz

[+491733109181](tel:+491733109181)

info@escapewelt.com

NEED HELP?

If you have any difficulties, or you don't have enough free time, then scan the QR-code to get a hint and a solution.



DE

Benötigst du Hilfe? Bei Schwierigkeiten oder wenn du nicht genug Zeit hast, scanne den QR-Code, um einen Hinweis oder die Lösung zu erhalten.

ES

¿Necesitas ayuda? Si tienes alguna dificultad o no tienes suficiente tiempo libre, escanea el código QR para conseguir una pista y una solución.

FR

Besoin d'aide? Si vous avez des difficultés, ou si vous n'avez pas assez de temps libre, scannez le code QR pour obtenir un indice et une solution.

JP

助けが必要ですか?
QRコードをスキャンして、ヒントと解決策をご確認いただけます。



SCAN ME FOR TIPS

OPEN THE HIDDEN CHAMBER



DE

Öffne die
verborgene
Kammer!

ES

¡Abre la cámara
secreta!

FR

Ouvrir la chambre
cachée!

JP

隠された部屋
を開けよう!

HIDE YOUR GIFT

**DE**Verstecke dein
Geschenk**ES**

Esconde tu regalo

FROuvrir la chambre
cachée**JP**プレゼントを
隠そう

GIFT

LET YOUR LOVED ONES SOLVE ALL THE PUZZLES

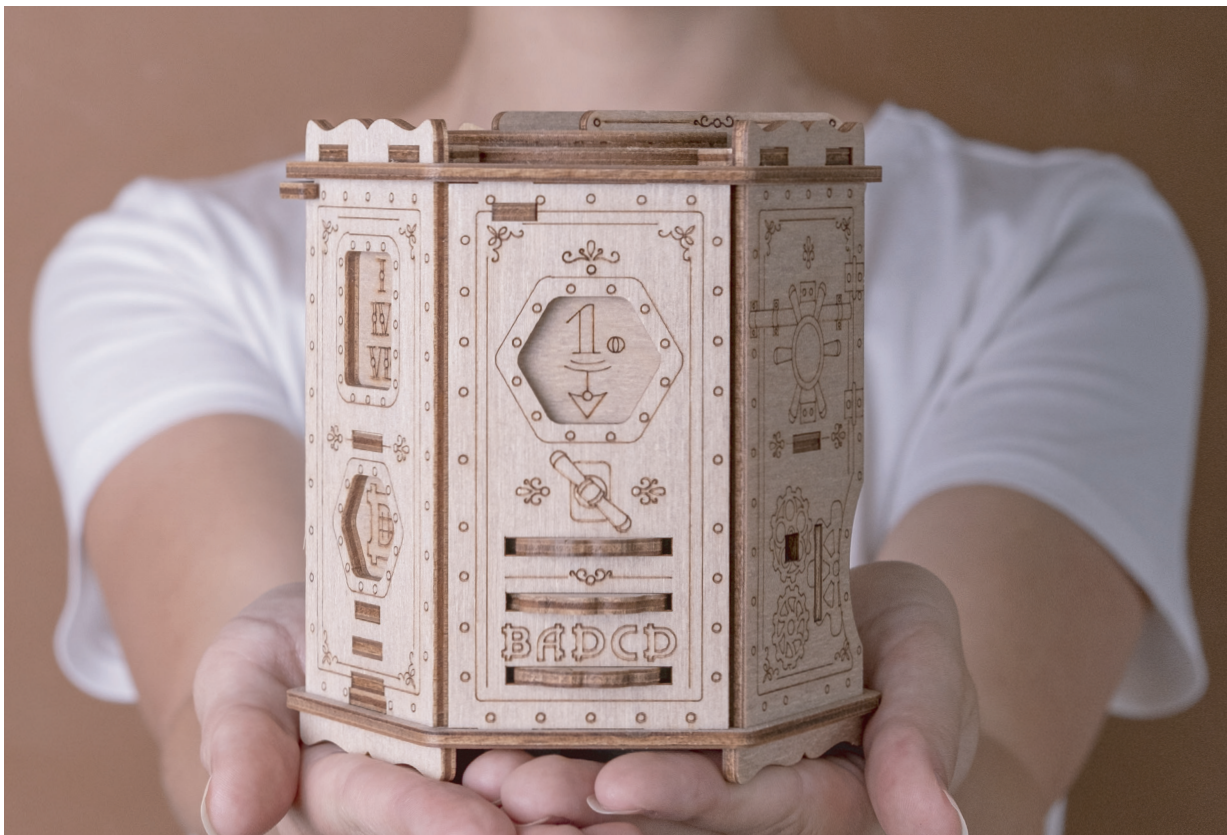

DE

Lass deine Liebsten alle
Rätsel lösen

ES

Deja que tus seres queridos
resuelvan todos los
rompecabezas

FR

Laissez vos proches résoudre
toutes les énigmes

JP

好きな人にすべてのパ
ズルを解いてもらいま
しょう

CHECK OUT OUR OTHER GAMES!

DE Entdecke auch unsere anderen Spiele! ES Descubre nuestros otros juegos! FR Regardez nos autres jeux! JP 弊社のその他のゲームもご覧ください!

ESCAPE ROOM IN A BOX & PUZZLES



QUEST PYRAMID

Unravel the secrets of Ancient Egypt

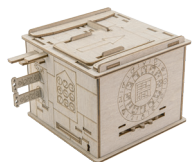

SPACE BOX

Breathtaking Space Odyssey in the comfort of your own home



FORT KNOX

Open the box and complete your secret mission!



ORBITAL BOX

Challenge your brain to find a way out



HOUSE OF THE DRAGON

For all fans of Japanese history



FORT KNOX BOX PRO

New version of a legendary toy



QUEST PUZZLE

Try to solve it in 60 minutes!

3 IN 1 — 3D PUZZLES GAMES



LABYRINTH PUZZLE

It's actually harder than it seems



QUEST PYRAMID



SPACE BOX



ORBITAL BOX



SCAN ME AND GET MORE OF OUR TOYS AND PUZZLES

LET'S STAY IN TOUCH!

Learn more about EscapeWelt



[ESCAPEWELT.COM](https://www.escapewelt.com)

Do you prefer shopping on Amazon?



[VISIT US](#)

Join us on social platforms, stay up to date with the news and participate in giveaways



[@escapewelt](https://www.instagram.com/escapewelt)



[@EscapeWelt](https://www.facebook.com/EscapeWelt)



t.me/escapeweltquiz

[+491733109181](tel:+491733109181)

info@escapewelt.com